

Systems Guide

2013



Systems Guide

LOGIX™ Integrated Ceiling Systems from CGC allow you to design ceilings that meet building requirements without being constrained by the limits of traditional acoustical ceilings. LOGIX™ transforms visual distractions such as lighting, air vents and other utilities into dramatic design elements by concentrating these fixtures on narrow 4", 6" and 12" channels. This allows for open ceilings that are uncluttered by ceiling utilities and offer a clean, monolithic, custom look with standard components.

LOGIX™ is compatible with a wide selection of 4", 6" and 12" luminaires including Lumination™ LED Luminaires by GE Lighting Solutions. For more information visit: www.gelightingsolutions.com.

	Pages	
Understand Your System	2	Overview
Plan Your System	5	Options LOGIX™ Universal Yoke
Design Your System	12	Design Considerations
Select Your System	14	On-Module Channel Spacing Off-Module Channel Spacing
	126	Metric Systems
For More Information	1-800-387-2690	Web Site cgcinc.com

LOGIX™ Integrated Ceiling Systems

Overview

A wide selection of acoustical and specialty panels as well as four corresponding suspension system profiles are available to enhance and customize your design. Plus, with a wide selection of LOGIX™ partners, you can be assured that ceiling utilities will complement your design and integrate seamlessly into the ceiling.

Office



LOGIX™ Integrated Ceiling Systems

Overview

Transform lighting, ventilation and other utilities from visual distractions to dramatic design elements by concentrating these fixtures on narrow bands running the length of a ceiling. Suddenly, the ceiling is neat and orderly, allowing wide open spaces uninterrupted by mechanical components.

Conference Room



LOGIX™ Integrated Ceiling Systems

Overview

Accentuate vertical elements and create a custom look without the custom cost using standard products, panels and components. Position channels between main tees, allowing you to enliven your design with continuous, uninterrupted, decorative functional channels.

Corridor





LOGIX™ Integrated Ceiling Systems

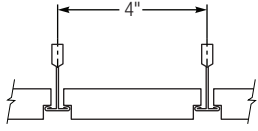
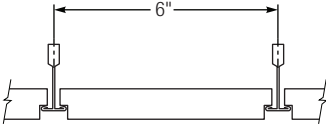
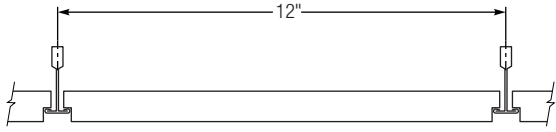
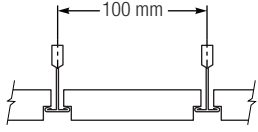
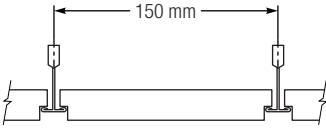
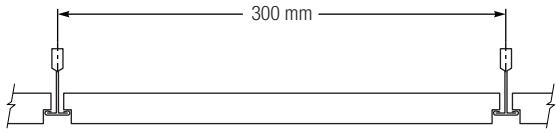



Channel Options

Channel Options	Imperial	4" Channel	6" Channel
			
		12" Channel 	
	Metric	100mm Channel	150mm Channel
			
		300mm Channel 	

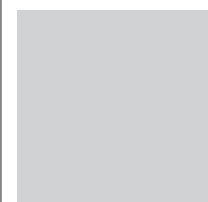
LOGIX™ Integrated Ceiling Systems





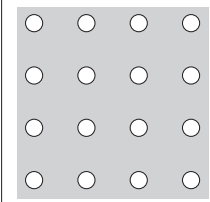
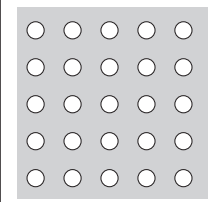





Panel Options

Field Panel Options	HALCYON™ CLIMAPLUS™ Fiberglass	MARS™ CLIMAPLUS™ X-Technology Mineral Fiber	MARS™ CLIMAPLUS™ High NRC X-Technology Mineral Fiber	
				
	PANZ® Unperforated Metal Aluminum			
				

Channel Panel Options	HALCYON™ CLIMAPLUS™ Fiberglass	MARS™ CLIMAPLUS™ X-Technology Mineral Fiber	MARS™ CLIMAPLUS™ High NRC X-Technology Mineral Fiber	
				
	PANZ® Unperforated Metal Aluminum	PANZ® Perforated C116 Aluminum	PANZ® Perforated C116D Aluminum	
				

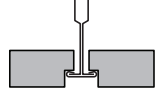
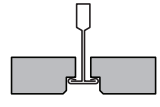
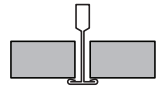
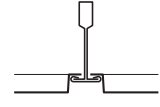
LOGIX™ Integrated Ceiling Systems

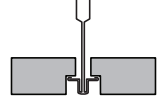
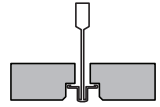
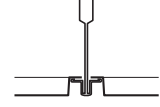
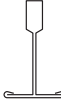
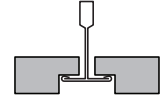
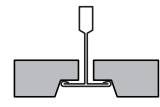
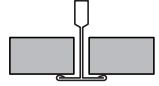

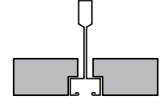
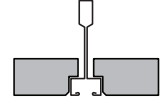
Suspension Systems

		Panel Edge Options				
		FL	FLB	SL	SLT	SQ
Suspension Systems	CENTRICITEE™ DXT™ 					
						Maximum 2'x2' SQ Edge panels with DXT™. 
	PANZ® Metal					
	IDENTITEE™ DXI™ 					
	PANZ® Metal					
	DONN® DX®/DXL™ 					
	FINELINE® DXF™ 	FINELINE® DXF™ available through special order.				
						

LOGIX™ Integrated Ceiling Systems

Connector Panels

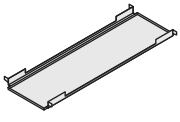
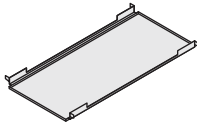
The LOGIX™ connector panel is a unique way to visually connect various utilities such as luminaires and channel panels. The connector panels are configured to carry the adjacent panel or fixture, no special fixture type or tile edge is needed. Metric sizes are also available.

4" Connector Panel	6" Connector Panel	FINELINE™ (FL)	Flush Mount (FM)
			

Order Information

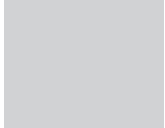
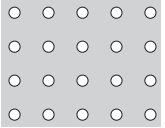
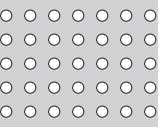
Finish			Packaging 10 pcs./ctn.
Smooth, Unperforated	Perforated C116	Perforated C116D	
			

Panel Size	Colour	Edge	Item Number	Item Number	Item Number	Width	Length	Height	
4" x 12"	Flat White Painted	FINELINE™ (FL)	LCP412-S-FL			4.125"	13.25"	5.75"	
		Flush Mount (FM)	LCP412-S-FM			4.125"	13.25"	4"	
		FINELINE™ (FL)		LCP412-C116-FL		4.125"	13.25"	5.75"	
		Flush Mount (FM)		LCP412-C116-FM		4.125"	13.25"	4"	
		FINELINE™ (FL)			LCP412-C116D-FL		4.125"	13.25"	5.75"
		Flush Mount (FM)			LCP412-C116D-FM		4.125"	13.25"	4"
4" x 24"	Flat White Painted	FINELINE™ (FL)	LCP424-S-FL			4.125"	13.25"	5.75"	
		Flush Mount (FM)	LCP424-S-FM			4.125"	13.25"	4"	
		FINELINE™ (FL)		LCP424-C116-FL		4.125"	13.25"	5.75"	
		Flush Mount (FM)		LCP424-C116-FM		4.125"	13.25"	4"	
		FINELINE™ (FL)			LCP424-C116D-FL		4.125"	13.25"	5.75"
		Flush Mount (FM)			LCP424-C116D-FM		4.125"	13.25"	4"
6" x 12"	Flat White Painted	FINELINE™ (FL)	LCP612-S-FL			6.125"	13.25"	5.75"	
		Flush Mount (FM)	LCP612-S-FM			6.125"	13.25"	4"	
		FINELINE™ (FL)		LCP612-C116-FL		6.125"	13.25"	5.75"	
		Flush Mount (FM)		LCP612-C116-FM		6.125"	13.25"	4"	
		FINELINE™ (FL)			LCP612-C116D-FL		6.125"	13.25"	5.75"
		Flush Mount (FM)			LCP612-C116D-FM		6.125"	13.25"	4"
6" x 24"	Flat White Painted	FINELINE™ (FL)	LCP624-S-FL			6.125"	25.25"	5.75"	
		Flush Mount (FM)	LCP624-S-FM			6.125"	25.25"	4"	
		FINELINE™ (FL)		LCP624-C116-FL		6.125"	25.25"	5.75"	
		Flush Mount (FM)		LCP624-C116-FM		6.125"	25.25"	4"	
		FINELINE™ (FL)			LCP624-C116D-FL		4.125"	25.25"	5.75"
		Flush Mount (FM)			LCP624-C116D-FM		4.125"	25.25"	4"

LOGIX™ Integrated Ceiling Systems

LOGIX™ Universal Yoke

The LOGIX™ yoke is compatible with both metric and imperial utility channel sizes. The yoke keeps hanger wire wraps away from linear luminaires and may reduce the number of hanger wires required. The yoke also helps to brace the utility channel. The yoke is easy to install and seismic tested.

Yoke Imperial

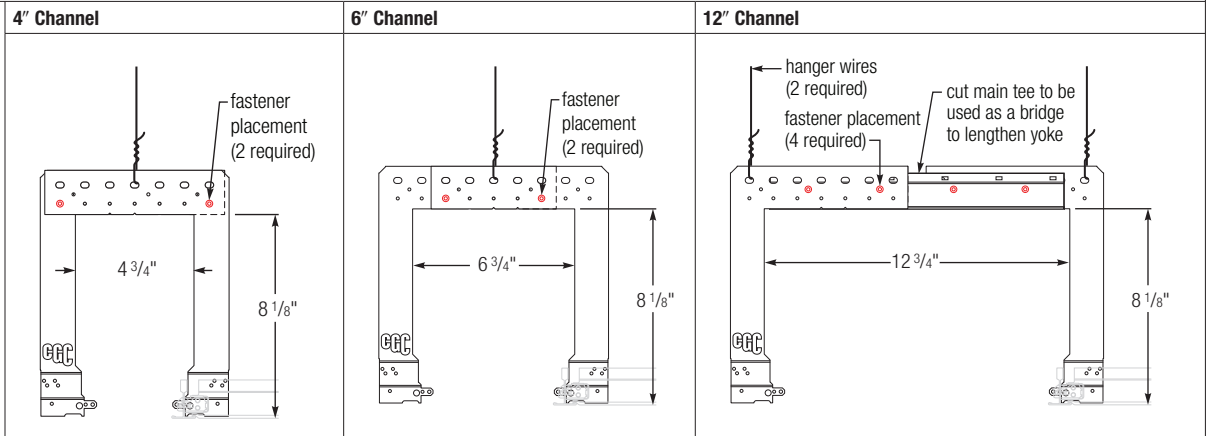

Yoke Metric

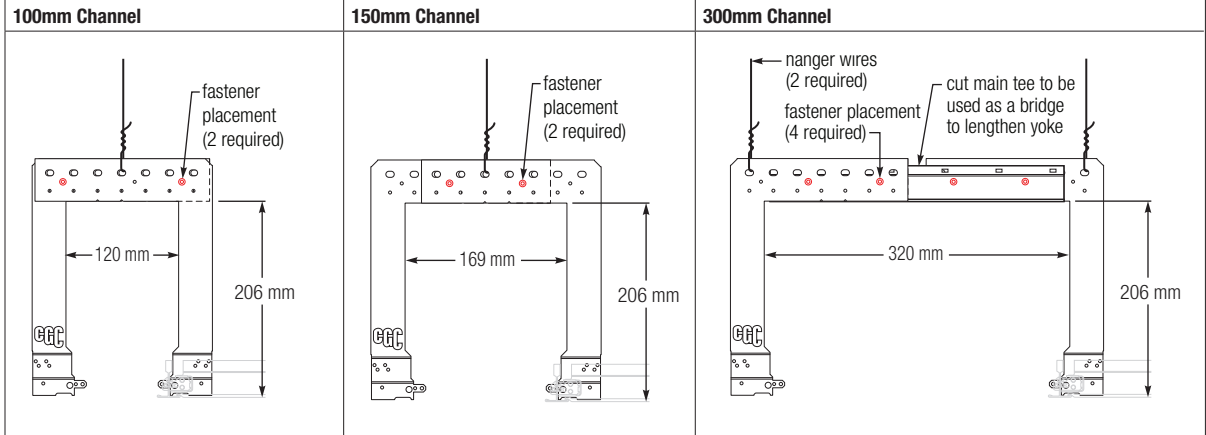

LOGIX™ Integrated Ceiling Systems

Yoke Assemblies

Yoke with Connector Panel

The LOGIX™ yoke is compatible with all utility channel options and applications. The connector panel shown is one of many options allowing the freedom to transform the utilities into dramatic design elements.

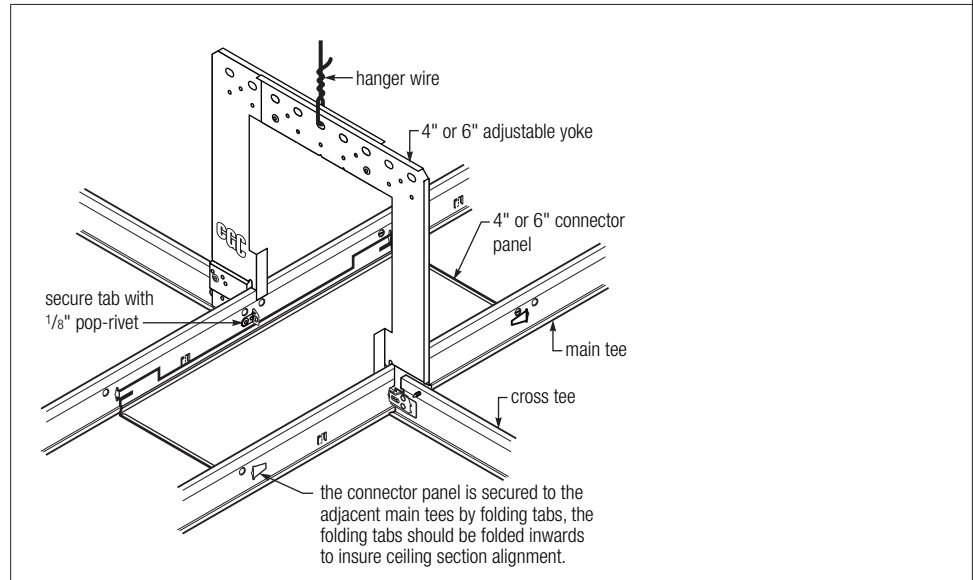

Yoke with Recessed Linear Luminaires

LOGIX™ is compatible with a wide selection of 4", 6" and 12" luminaires including Lumination™ LED Luminaires by GE Lighting Solutions. For more information visit: www.gelightsolutions.com.

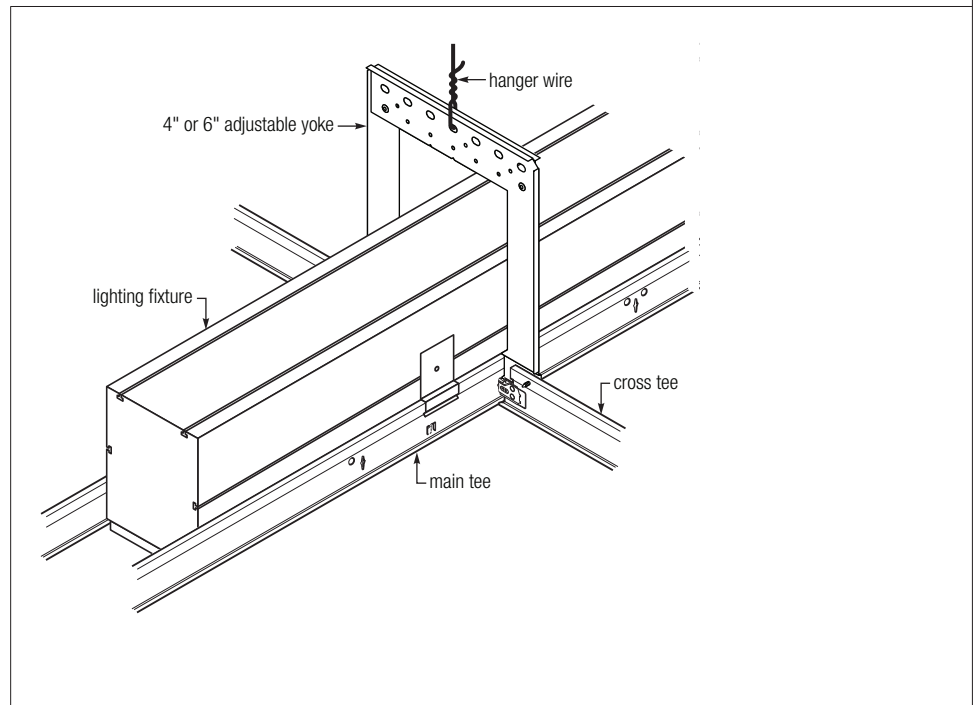

LOGIX™ Integrated Ceiling Systems

Layout Options

Utility Channel Created with Main Tees

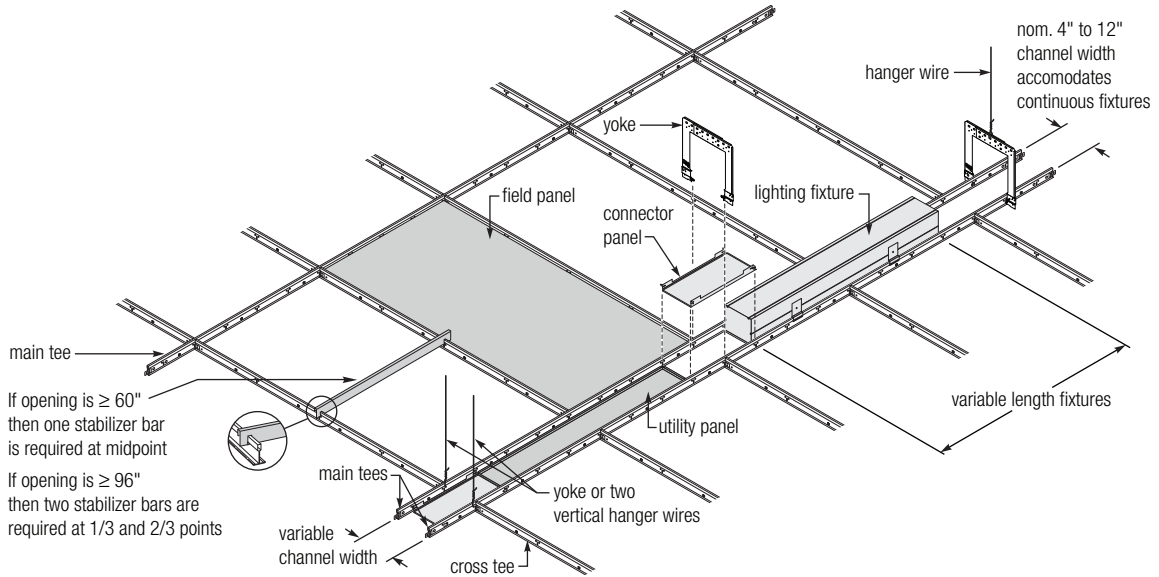

Utility Channel Created with Cross Tees

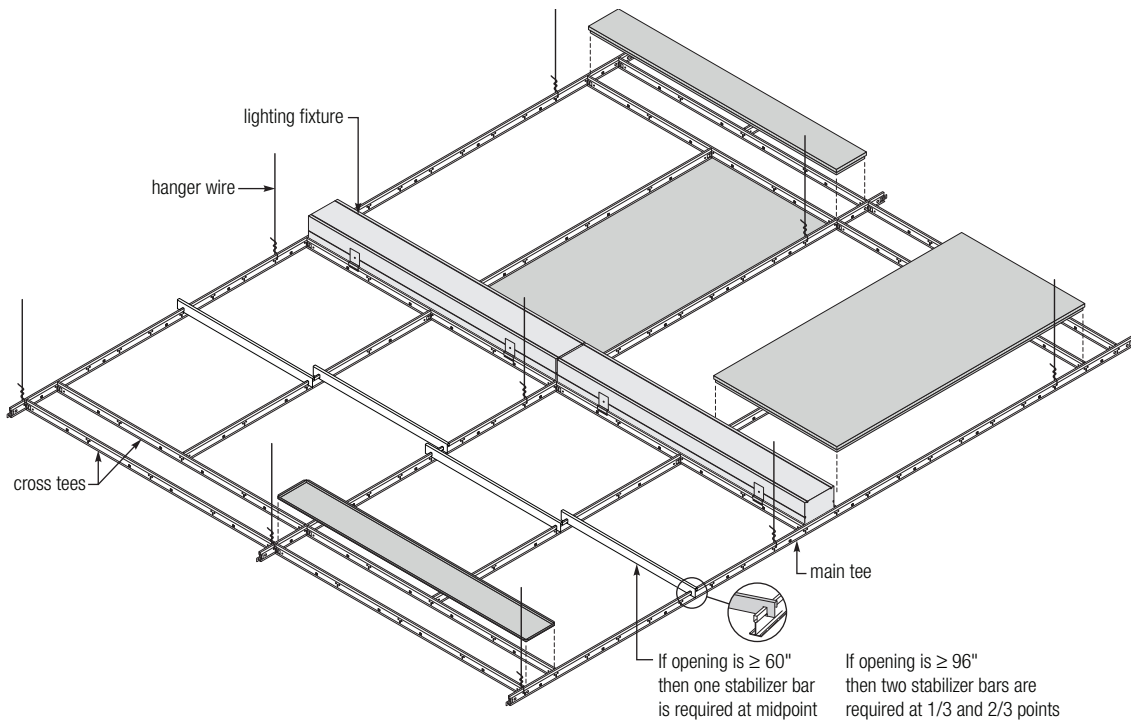

Design Considerations

Ceiling Modules

Off-Module Units

Off-Module units represent assemblies where typical ceiling panel sizes are utilized between the utility channels. With the addition of the utility channel this creates off-module or nonstandard channel-to-channel spacing.

On-Module Units

On-Module units represent assemblies where atypical ceiling panel sizes are utilized between the utility channels. With the addition of the utility channel this creates on-module or standard channel-to-channel spacing.

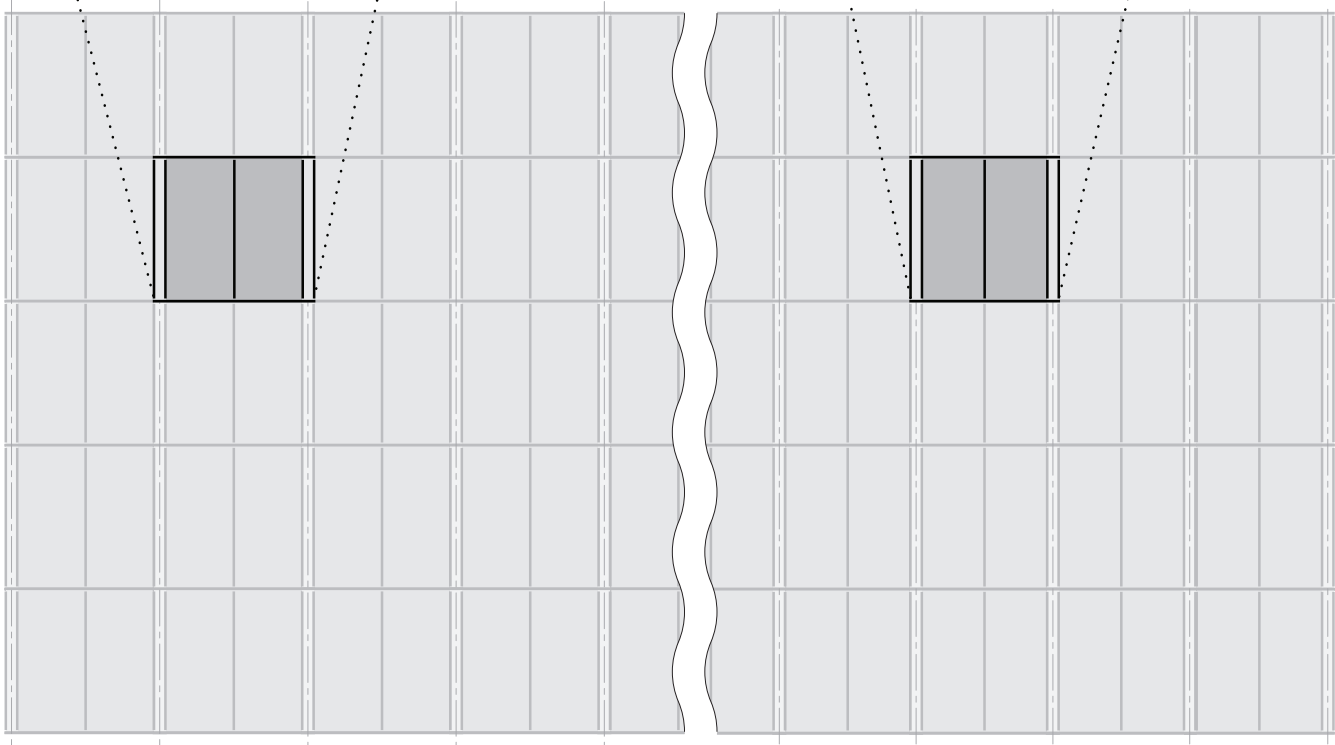
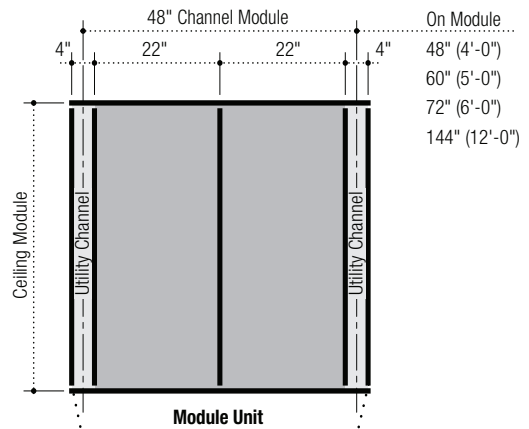
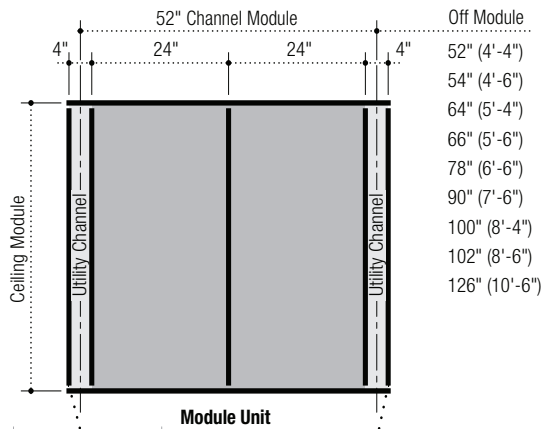

Design Considerations

Utility Channel Options

Utility Channel Example Layouts



Utility Applications

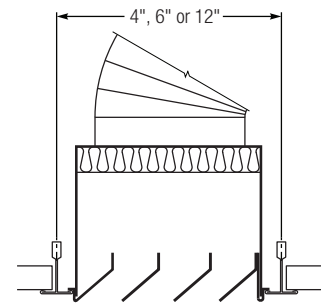

Air Diffuser

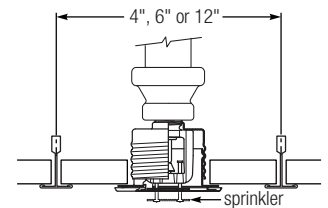

Sprinkler System

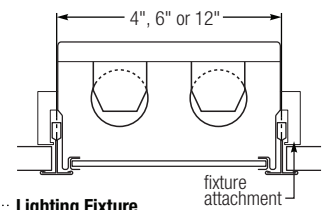

Lighting Fixture

Other ceiling mounted devices not shown such as:









- Cameras
- Fire Alarms
- Smoke Detectors
- Speakers, etc.

Channel Panel Options

- Perforated Metal
- Unperforated Metal
- HALCYON™ CLIMAPLUS™
- MARS™ CLIMAPLUS™
- MARS™ CLIMAPLUS™ High NRC





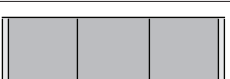





On-Module Spacing

4' and 5' Ceiling Modules

	Channel Width	Ceiling Module	On-Center Channel Spacing	Field Panels	PANZ® Metal Option		System	Page
					Field Panel	Channel Panel		
4" Channel								
	4"	4'	4'	22" x 48"			764	20-21
	4"	4'	4'	22" x 24"			996	22-23
	4"	4'	4'	44" x 24"			952	24-25
	4"	4'	4'	44" x 48"			375	26-27
	4"	5'	5'	56" x 20"			537	28-29
	4"	5'	5'	28" x 30"			339	30-31
	4"	5'	5'	28" x 60"			433	32-33
	4"	5'	5'	56" x 30"			524	34-35
	4"	4'	12'	46" x 48" 48" x 48"			795	36-37









On-Module Spacing

4' and 5' Ceiling Modules

	Channel Width	Ceiling Module	On-Center Channel Spacing	Field Panels	PANZ® Metal Option		System	Page
					Field Panel	Channel Panel		
6" Channel								
	6"	4'	4'	42" x 48"		•	346	38-39
	6"	4'	4'	42" x 24"		•	727	40-41
	6"	4'	4'	21" x 24"		•	838	42-43
	6"	4'	4'	21" x 48"		•	646	44-45
	6"	4'	5'	54" x 48"		•	363	46-47
	6"	5'	5'	54" x 20"		•	753	48-49
	6"	5'	5'	27" x 30"		•	856	50-51
	6"	5'	5'	27" x 60"		•	343	52-53
	6"	5'	5'	54" x 30"		•	865	54-55
	6"	5'	12'	45" x 48" 48" x 48"		•	275	56-57

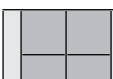
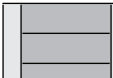

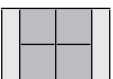









On-Module Spacing

4' and 5' Ceiling Modules

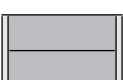
	Channel Width	Ceiling Module	On-Center Channel Spacing	Field Panels	PANZ [®] Metal Option		System	Page
					Field Panel	Channel Panel		
12" Channel								
	12"	4'	5'	24" x 48"	●	●	944	58-59
	12"	4'	5'	24" x 24"	●	●	464	60-61
	12"	4'	5'	48" x 48"		●	279	62-63
	12"	5'	6'	30" x 60"	●	●	372	64-65
	12"	5'	6'	30" x 30"	●	●	934	66-67
	12"	5'	6'	60" x 20"	●	●	649	68-69
	12"	6'	5'	24" x 48"	●	●	997	70-71
	12"	6'	5'	24" x 24"	●	●	665	72-73
	12"	6'	5'	24" x 72"	●	●	785	74-75

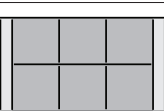

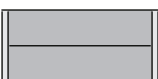







Off-Module Spacing

4', 5' and 6' Ceiling Modules
 4", 6" and 12" Configurations

	Channel Width	Ceiling Module	On-Center Channel Spacing	Field Panels	PANZ [®] Metal Option		System	Page
					Field Panel	Channel Panel		
	4"	4'	4' - 4"	24" x 48"	●		367	76-77
	6"	4'	4' - 6"	24" x 48"	●	●	598	78-79
	4"	4'	4' - 4"	24" x 24"	●		977	80-81
	6"	4'	4' - 6"	24" x 24"	●	●	862	82-83
	4"	4'	4' - 4"	48" x 48"			527	84-85
	6"	4'	4' - 6"	48" x 48"		●	244	86-87
	4"	4'	6' - 6"	72" x 24"	●		529	88-89
	6"	4'	6' - 6"	72" x 24"	●	●	755	90-91
	6"	4'	6' - 6"	24" x 24"	●	●	574	92-93
	6"	4'	7' - 6"	42" x 48"		●	497	94-95
	4"	4'	8' - 4"	96" x 24"			722	96-97
	6"	4'	8' - 6"	48" x 48"		●	754	98-99



Off-Module Spacing

4', 5' and 6' Ceiling Modules
 4", 6" and 12" Configurations

	Channel Width	Ceiling Module	On-Center Channel Spacing	Field Panels	PANZ® Metal Option		System	Page
					Field Panel	Channel Panel		
	6"	4'	8' - 6"	96" x 24"		●	664	100-101
	6"	4'	8' - 6"	96" x 48"		●	979	102-103
	6"	4'	8' - 6"	24" x 24"	●	●	776	104-105
	6"	4'	10' - 6"	120" x 24"		●	383	106-107
	4"	5'	5' - 4"	30" x 60"	●		697	108-109
	6"	5'	5' - 6"	30" x 60"	●	●	369	110-111
	4"	5'	5' - 4"	30" x 30"		●	378	112-113
	6"	5'	5' - 6"	30" x 30"	●	●	642	114-115
	4"	6'	4' - 4"	24" x 48"	●	●	859	116-117
	6"	6'	4' - 6"	24" x 48"	●	●	824	118-119

Off-Module Spacing

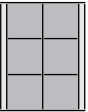
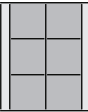
4', 5' and 6' Ceiling Modules
 4", 6" and 12" Configurations

	Channel Width	Ceiling Module	On-Center Channel Spacing	Field Panels	PANZ [®] Metal Option		System	Page
					Field Panel	Channel Panel		
	4"	6'	4' - 4"	24" x 24"	●	●	724	120-121
	6"	6'	4' - 6"	24" x 24"	●	●	292	122-123
	4"	6'	4' - 4"	24" x 72"	●	●	562	124-125
	6"	6'	4' - 6"	24" x 72"	●	●	643	126-127

On-Module Channel Spacing









4' Ceiling Module

4" Channel

System 764

22" x 48" Field Panel

Selector

Channel Width	Ceiling Module	On-Center Channel Spacing	Field Panels	Panel Edge	Suspension System
4"	4' (48")	4' (48")	HALCYON™ CLIMAPLUS™ 22" x 48" x 1"	FL 	DXT™, DXI™
				SL 	DX®
				SQ 	DX®
			MARS™ CLIMAPLUS™ 22" x 48 x 3/4"	FLB 	DXT™, DXI™
				SLT 	DX®
				SQ 	DX®
			MARS™ CLIMAPLUS™ High-NRC 22" x 48" x 7/8"	FLB 	DXT™, DXI™
				SLT 	DX®
				SQ 	DX®

Module Layout

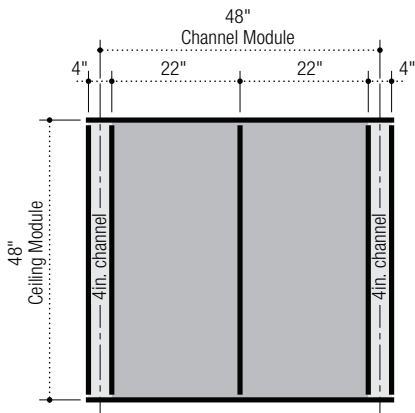

Panel Layout

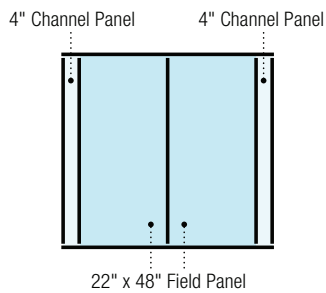

Suspension System Layout

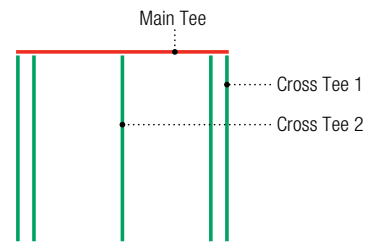

Order Information
System 764

4' Ceiling Module

4" Channel
22" x 48" Field Panel



Step 1. Select Panels

Step 2. Select Edge for Panels

			FL/FLB		SL/SLT		SQ	
			Edge	Item No.	Edge	Item No.	Edge	Item No.
Field Panels	HALCYON™ CLIMAPLUS™	22" x 48" x 1"	FL	<input type="checkbox"/> 97468	SL	<input type="checkbox"/> 97441	SQ	<input type="checkbox"/> 97414
	MARS™ CLIMAPLUS™	22" x 48" x 3/4"	FLB	<input type="checkbox"/> 86575	SLT	<input type="checkbox"/> 86553	SQ	<input type="checkbox"/> 86525
	MARS™ CLIMAPLUS™ High-NRC	22" x 48" x 7/8"	FLB	<input type="checkbox"/> 86486	SLT	<input type="checkbox"/> 86454	SQ	<input type="checkbox"/> 86417

Channel Panels	MARS™ CLIMAPLUS™	4" x 48" x 3/4"	FLB	<input type="checkbox"/> 86568	SLT	<input type="checkbox"/> 86540	SQ	<input type="checkbox"/> 86514
	MARS™ CLIMAPLUS™ High-NRC	4" x 48" x 7/8"	FLB	<input type="checkbox"/> 86475	SLT	<input type="checkbox"/> 86440	SQ	<input type="checkbox"/> 86402

Step 3. Select Corresponding Grid for Selected Panels

			Qty	Item No.	Qty	Item No.	Qty	Item No.
Suspension Systems	CENTRICITEE™ DXT™	Main Tee		<input type="checkbox"/> DXT24SP101				
		Cross Tee 1	2	<input type="checkbox"/> DXT424				
		Cross Tee 2	1	<input type="checkbox"/> DXT424				
	IDENTITEE™ DXI™	Main Tee		<input type="checkbox"/> DXI24SP101				
		Cross Tee 1	2	<input type="checkbox"/> DXI424				
		Cross Tee 2	1	<input type="checkbox"/> DXI424				
	DONN® DX®	Main Tee				<input type="checkbox"/> DX24SP101		<input type="checkbox"/> DX24SP101
		Cross Tee 1			2	<input type="checkbox"/> DX422	2	<input type="checkbox"/> DX422
		Cross Tee 2			1	<input type="checkbox"/> DX422	1	<input type="checkbox"/> DX422

Suspension System Estimator

	Length	Sq. Ft.	Main Tee Usage Per Sq. Ft.	Cross Tee 1 Usage Per Sq. Ft.	Cross Tee 2 Usage Per Sq. Ft.	
System Module	48"	16	0.25	0.50	0.25	

Note: Multiply the ceiling area (SF) by the Usage Factor (UF). This calculation will determine lineal footage of suspension system components required. Please refer to page 11 for stabilizer bar usage.









On-Module Channel Spacing

System 996

4' Ceiling Module

4" Channel
22" x 24" Field Panel

Selector

Channel Width	Ceiling Module	On-Center Channel Spacing	Field Panels	Panel Edge	Suspension System
4"	4' (48")	4' (48")	HALCYON™ CLIMAPLUS™ 22" x 24" x 1"	FL 	DXT™, DXI™
				SL 	DX®
				SQ 	DX®, DXT™
			MARS™ CLIMAPLUS™ 22" x 24" x 3/4"	FLB 	DXT™, DXI™
				SLT 	DX®
				SQ 	DX®, DXT™
			MARS™ CLIMAPLUS™ High-NRC 22" x 24" x 7/8"	FLB 	DXT™, DXI™
				SLT 	DX®
				SQ 	DX®, DXT™

Module Layout

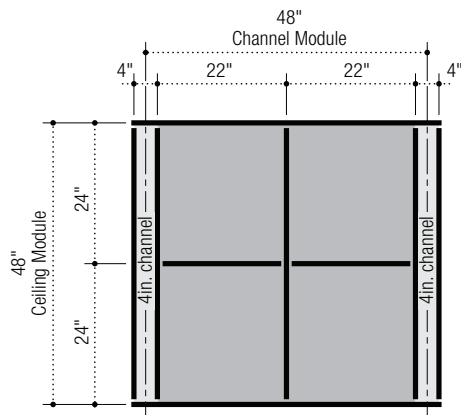

Panel Layout

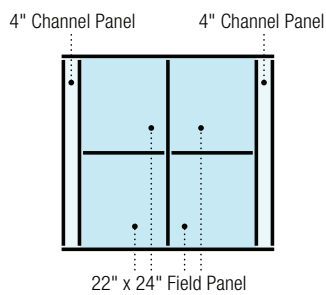

Suspension System Layout

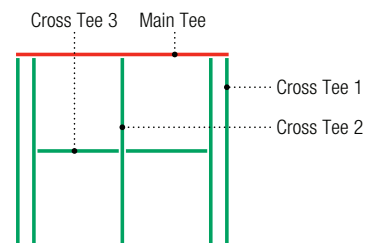

Order Information
System 996

4' Ceiling Module

4" Channel
22" x 24" Field Panel



Step 1. Select Panels

Step 2. Select Edge for Panels

			FL/FLB		SL/SLT		SQ	
			Edge	Item No.	Edge	Item No.	Edge	Item No.
Field Panels	HALCYON™ CLIMAPLUS™	22" x 24" x 1"	FL	<input type="checkbox"/> 97467	SL	<input type="checkbox"/> 97440	SQ	<input type="checkbox"/> 97413
	MARS™ CLIMAPLUS™	22" x 24" x 3/4"	FLB	<input type="checkbox"/> 86574	SLT	<input type="checkbox"/> 86552	SQ	<input type="checkbox"/> 86524
	MARS™ CLIMAPLUS™ High-NRC	22" x 24" x 7/8"	FLB	<input type="checkbox"/> 86485	SLT	<input type="checkbox"/> 86453	SQ	<input type="checkbox"/> 86416
Channel Panels	MARS™ CLIMAPLUS™	4" x 48" x 3/4"	FLB	<input type="checkbox"/> 86568	SLT	<input type="checkbox"/> 86540	SQ	<input type="checkbox"/> 86514
	MARS™ CLIMAPLUS™ High-NRC	4" x 48" x 7/8"	FLB	<input type="checkbox"/> 86475	SLT	<input type="checkbox"/> 86440	SQ	<input type="checkbox"/> 86402

Step 3. Select Corresponding Grid for Selected Panels

			Qty	Item No.	Qty	Item No.	Qty	Item No.
			Suspension Systems	CENTRICITEE™ DXT™	Main Tee		<input type="checkbox"/> DXT24SP101	
Cross Tee 1	2	<input type="checkbox"/> DXT424					2	<input type="checkbox"/> DXT424
Cross Tee 2	1	<input type="checkbox"/> DXT424					1	<input type="checkbox"/> DXT424
Cross Tee 3	2	<input type="checkbox"/> DXT2222					2	<input type="checkbox"/> DXT2222
IDENTITEE™ DXI™	Main Tee			<input type="checkbox"/> DXI24SP101				
	Cross Tee 1	2		<input type="checkbox"/> DXI424				
	Cross Tee 2	1		<input type="checkbox"/> DXI424				
	Cross Tee 3	2		<input type="checkbox"/> DXT2222				
DONN® DX®	Main Tee					<input type="checkbox"/> DX24SP101		<input type="checkbox"/> DX24SP101
	Cross Tee 1				2	<input type="checkbox"/> DX422	2	<input type="checkbox"/> DX422
	Cross Tee 2				1	<input type="checkbox"/> DX422	1	<input type="checkbox"/> DX422
	Cross Tee 3				2	<input type="checkbox"/> DX2216	2	<input type="checkbox"/> DX2216

Suspension System Estimator

	Length	Sq. Ft.	Main Tee Usage Per Sq. Ft.	Cross Tee 1 Usage Per Sq. Ft.	Cross Tee 2 Usage Per Sq. Ft.	Cross Tee 3 Usage Per Sq. Ft.
System Module	48"	16	0.25	0.50	0.25	0.23

Note: Multiply the ceiling area (SF) by the Usage Factor (UF). This calculation will determine lineal footage of suspension system components required. Please refer to page 11 for stabilizer bar usage.









On-Module Channel Spacing

System 952

4' Ceiling Module

4" Channel
44" x 24" Field Panel

Selector

Channel Width	Ceiling Module	On-Center Channel Spacing	Field Panels	Panel Edge	Suspension System
4"	4' (48")	4' (48")	HALCYON™ CLIMAPLUS™ 44" x 24" x 1"	FL 	DXT™, DXI™
				SL 	DX°
				SQ 	DX°
			MARS™ CLIMAPLUS™ 44" x 24" x 3/4"	FLB 	DXT™, DXI™
				SLT 	DX°
				SQ 	DX°
			MARS™ CLIMAPLUS™ High-NRC 44" x 24" x 7/8"	FLB 	DXT™, DXI™
				SLT 	DX°
				SQ 	DX°

Module Layout

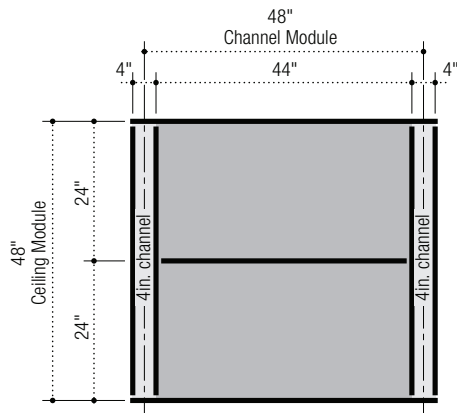

Panel Layout

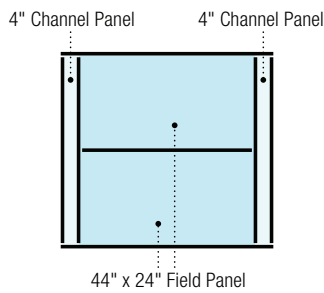

Suspension System Layout

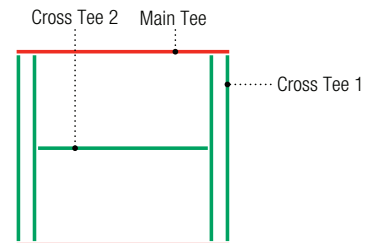

Order Information
System 952

4' Ceiling Module

4" Channel
44" x 24" Field Panel



Step 1. Select Panels

Step 2. Select Edge for Panels

			FL/FLB		SL/SLT		SQ	
			Edge	Item No.	Edge	Item No.	Edge	Item No.
Field Panels	HALCYON™ CLIMAPLUS™	44" x 24" x 1"	FL	<input type="checkbox"/> 97470	SL	<input type="checkbox"/> 97444	SQ	<input type="checkbox"/> 97416
	MARS™ CLIMAPLUS™	44" x 24" x 3/4"	FLB	<input type="checkbox"/> 86578	SLT	<input type="checkbox"/> 86556	SQ	<input type="checkbox"/> 86528
	MARS™ CLIMAPLUS™ High-NRC	44" x 24" x 7/8"	FLB	<input type="checkbox"/> 86489	SLT	<input type="checkbox"/> 86457	SQ	<input type="checkbox"/> 86420

Channel Panels	MARS™ CLIMAPLUS™	4" x 48" x 3/4"	FLB	<input type="checkbox"/> 86568	SLT	<input type="checkbox"/> 86540	SQ	<input type="checkbox"/> 86514
	MARS™ CLIMAPLUS™ High-NRC	4" x 48" x 7/8"	FLB	<input type="checkbox"/> 86475	SLT	<input type="checkbox"/> 86440	SQ	<input type="checkbox"/> 86402

Step 3. Select Corresponding Grid for Selected Panels

			Qty	Item No.	Qty	Item No.	Qty	Item No.
Suspension Systems	CENTRICITEE™ DXT™	Main Tee		<input type="checkbox"/> DXT24SP101				
		Cross Tee 1	2	<input type="checkbox"/> DXT424				
		Cross Tee 2	1	<input type="checkbox"/> DXT4422				
	IDENTITEE™ DXI™	Main Tee		<input type="checkbox"/> DXI24SP101				
		Cross Tee 1	2	<input type="checkbox"/> DXI424				
		Cross Tee 2	1	<input type="checkbox"/> DXI4424				
	DONN® DX®	Main Tee				<input type="checkbox"/> DX24SP101		<input type="checkbox"/> DX24SP101
		Cross Tee 1			2	<input type="checkbox"/> DX422	2	<input type="checkbox"/> DX422
		Cross Tee 2			1	<input type="checkbox"/> DX44	1	<input type="checkbox"/> DX44

Suspension System Estimator

	Length	Sq. Ft.	Main Tee Usage Per Sq. Ft.	Cross Tee 1 Usage Per Sq. Ft.	Cross Tee 2 Usage Per Sq. Ft.	
System Module	48"	16	0.25	0.50	0.23	

Note: Multiply the ceiling area (SF) by the Usage Factor (UF). This calculation will determine lineal footage of suspension system components required. Please refer to page 11 for stabilizer bar usage.

On-Module Channel Spacing



4' Ceiling Module

4" Channel

System 375

44" x 48" Field Panel

Selector

Channel Width	Ceiling Module	On-Center Channel Spacing	Field Panels	Panel Edge	Suspension System
4"	4' (48")	4' (48")	HALCYON™ CLIMAPLUS™ 44" x 48" x 1"	FL 	DXT™, DXI™
				SL 	DX®
				SQ 	DX®

Module Layout

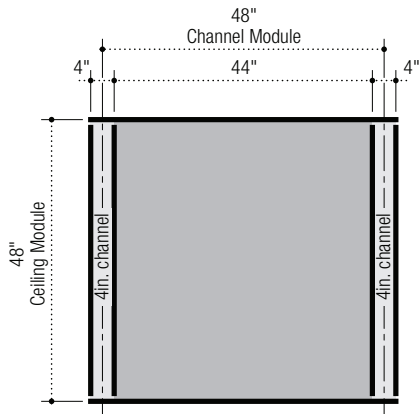

Panel Layout

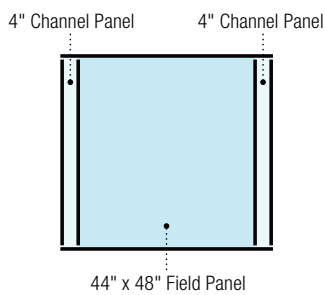

Suspension System Layout

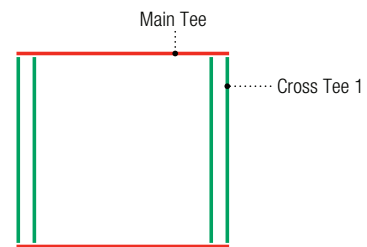

Order Information
System 375

4' Ceiling Module

4" Channel
44" x 48" Field Panel



Step 1. Select Panels

Step 2. Select Edge for Panels

			FL/FLB		SL/SLT		SQ	
			Edge	Item No.	Edge	Item No.	Edge	Item No.
Field Panels	HALCYON™ CLIMAPLUS™	44" x 48" x 1"	FL	<input type="checkbox"/> 97475	SL	<input type="checkbox"/> 97455	SQ	<input type="checkbox"/> 97425

Step 3. Select Corresponding Grid for Selected Panels

			Qty	Item No.	Qty	Item No.	Qty	Item No.
			Suspension Systems	CENTRICITEE™ DXT™	Main Tee		<input type="checkbox"/> DXT24SP101	
Cross Tee 1	2	<input type="checkbox"/> DXT424						
IDENTITEE™ DXI™	Main Tee			<input type="checkbox"/> DXI24SP101				
	Cross Tee 1	2		<input type="checkbox"/> DXI424				
DONN® DX®	Main Tee					<input type="checkbox"/> DX24SP101		<input type="checkbox"/> DX24SP101
	Cross Tee 1				2	<input type="checkbox"/> DX422	2	<input type="checkbox"/> DX422

Suspension System Estimator

	Length	Sq. Ft.	Main Tee Usage Per Sq. Ft.	Cross Tee 1 Usage Per Sq. Ft.	
System Module	48"	16	0.25	0.50	

Note: Multiply the ceiling area (SF) by the Usage Factor (UF). This calculation will determine lineal footage of suspension system components required. Please refer to page 11 for stabilizer bar usage.

On-Module Channel Spacing









System 537

5' Ceiling Module

4" Channel

56" x 20" Field Panel

Selector

Channel Width	Ceiling Module	On-Center Channel Spacing	Field Panels	Panel Edge	Suspension System
4"	5' (60")	5' (60")	HALCYON™ CLIMAPLUS™ 56" x 20" x 1"	FL 	DXT™, DXI™
				SL 	DX®
				SQ 	DX®
			MARS™ CLIMAPLUS™ 56" x 20" x 3/4"	FLB 	DXT™, DXI™
				SLT 	DX®
				SQ 	DX®
			MARS™ CLIMAPLUS™ High-NRC 56" x 20" x 7/8"	FLB 	DXT™, DXI™
				SLT 	DX®
				SQ 	DX®

Module Layout

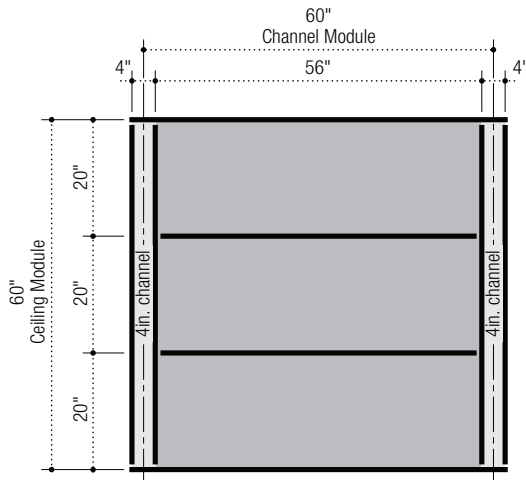

Panel Layout

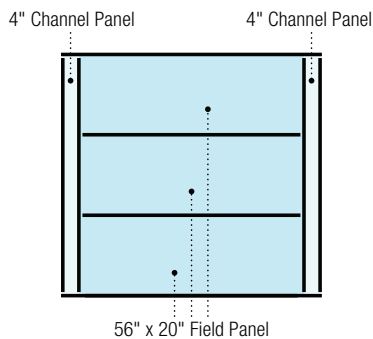

Suspension System Layout

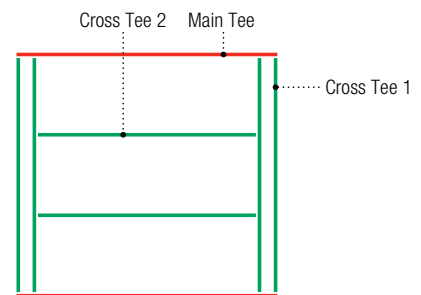

Order Information
System 537

5' Ceiling Module

4" Channel
56" x 20" Field Panel

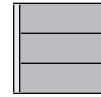

Step 1. Select Panels

Step 2. Select Edge for Panels

			FL/FLB		SL/SLT		SQ	
			Edge	Item No.	Edge	Item No.	Edge	Item No.
Field Panels	HALCYON™ CLIMAPLUS™	56" x 20" x 1"	FL	<input type="checkbox"/> 97464	SL	<input type="checkbox"/> 97437	SQ	<input type="checkbox"/> 97408
	MARS™ CLIMAPLUS™	56" x 20" x 3/4"	FLB	<input type="checkbox"/> 86571	SLT	<input type="checkbox"/> 86548	SQ	<input type="checkbox"/> 86520
	MARS™ CLIMAPLUS™ High-NRC	56" x 20" x 7/8"	FLB	<input type="checkbox"/> 86480	SLT	<input type="checkbox"/> 86448	SQ	<input type="checkbox"/> 86411
Channel Panels	MARS™ CLIMAPLUS™	4" x 60" x 3/4"	FLB	<input type="checkbox"/> 86569	SLT	<input type="checkbox"/> 86541	SQ	<input type="checkbox"/> 86515
	MARS™ CLIMAPLUS™ High-NRC	4" x 60" x 7/8"	FLB	<input type="checkbox"/> 86476	SLT	<input type="checkbox"/> 86441	SQ	<input type="checkbox"/> 86403

Step 3. Select Corresponding Grid for Selected Panels

			Qty	Item No.	Qty	Item No.	Qty	Item No.
Suspension Systems	CENTRICITEE™ DXT™	Main Tee		<input type="checkbox"/> DXT24SP102				
		Cross Tee 1	2	<input type="checkbox"/> DXT524				
		Cross Tee 2	2	<input type="checkbox"/> DXT5622				
	IDENTITEE™ DXI™	Main Tee		<input type="checkbox"/> DXI24SP102				
		Cross Tee 1	2	<input type="checkbox"/> DXI524				
		Cross Tee 2	2	<input type="checkbox"/> DXI5624				
	DONN® DX®	Main Tee				<input type="checkbox"/> DX24SP102		<input type="checkbox"/> DX24SP102
		Cross Tee 1			2	<input type="checkbox"/> DX524	2	<input type="checkbox"/> DX524
		Cross Tee 2			2	<input type="checkbox"/> DX5616	2	<input type="checkbox"/> DX5616

Suspension System Estimator

	Length	Sq. Ft.	Main Tee Usage Per Sq. Ft.	Cross Tee 1 Usage Per Sq. Ft.	Cross Tee 2 Usage Per Sq. Ft.	
System Module	60"	25	0.20	0.40	0.37	

Note: Multiply the ceiling area (SF) by the Usage Factor (UF). This calculation will determine lineal footage of suspension system components required. Please refer to page 11 for stabilizer bar usage.

On-Module Channel Spacing









5' Ceiling Module

4" Channel

System 339

28" x 30" Field Panel

Selector

Channel Width	Ceiling Module	On-Center Channel Spacing	Field Panels	Panel Edge	Suspension System
4"	5' (60")	5' (60")	HALCYON™ CLIMAPLUS™ 28" x 30" x 1"	FL 	DXT™, DXI™
				SL 	DX®
				SQ 	DX®
			MARS™ CLIMAPLUS™ 28" x 30" x 3/4"	FLB 	DXT™, DXI™
				SLT 	DX®
				SQ 	DX®
			MARS™ CLIMAPLUS™ High-NRC 28" x 30" x 7/8"	FLB 	DXT™, DXI™
				SLT 	DX®
				SQ 	DX®

Module Layout

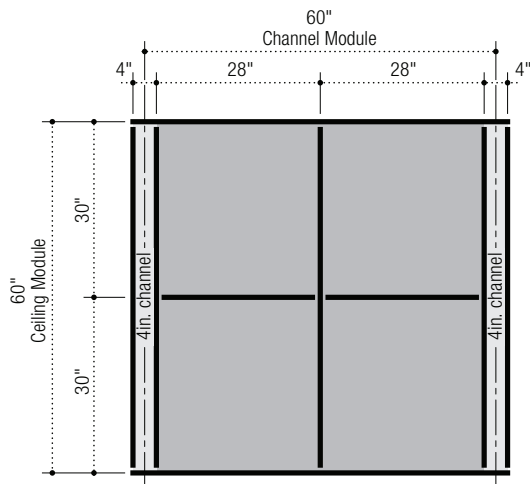

Panel Layout

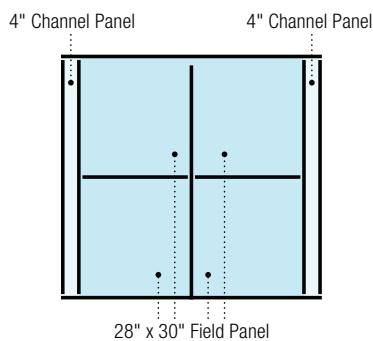

Suspension System Layout

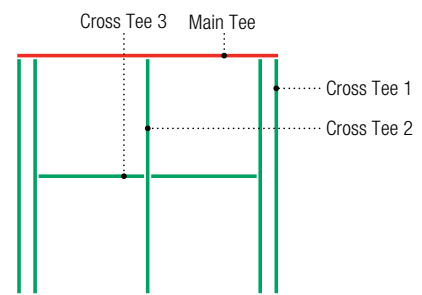

Order Information
System 339

5' Ceiling Module

4" Channel
28" x 30" Field Panel

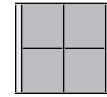

Step 1. Select Panels

Step 2. Select Edge for Panels

			FL/FLB		SL/SLT		SQ	
			Edge	Item No.	Edge	Item No.	Edge	Item No.
Field Panels	HALCYON™ CLIMAPLUS™	28" x 30" x 1"	FL	<input type="checkbox"/> 97335	SL	<input type="checkbox"/> 97449	SQ	<input type="checkbox"/> 97419
	MARS™ CLIMAPLUS™	28" x 30" x 3/4"	FLB	<input type="checkbox"/> 86834	SLT	<input type="checkbox"/> 86559	SQ	<input type="checkbox"/> 86532
	MARS™ CLIMAPLUS™ High-NRC	28" x 30" x 7/8"	FLB	<input type="checkbox"/> 86492	SLT	<input type="checkbox"/> 86459	SQ	<input type="checkbox"/> 86423
Channel Panels	MARS™ CLIMAPLUS™	4" x 60" x 3/4"	FLB	<input type="checkbox"/> 86569	SLT	<input type="checkbox"/> 86541	SQ	<input type="checkbox"/> 86515
	MARS™ CLIMAPLUS™ High-NRC	4" x 60" x 7/8"	FLB	<input type="checkbox"/> 86476	SLT	<input type="checkbox"/> 86441	SQ	<input type="checkbox"/> 86403

Step 3. Select Corresponding Grid for Selected Panels

			Qty	Item No.	Qty	Item No.	Qty	Item No.
Suspension Systems	CENTRICITEE™ DXT™	Main Tee		<input type="checkbox"/> DXT24SP102				
		Cross Tee 1	2	<input type="checkbox"/> DXT524				
		Cross Tee 2	1	<input type="checkbox"/> DXT524				
		Cross Tee 3	2	<input type="checkbox"/> DXT2822				
	IDENTITEE™ DXI™	Main Tee		<input type="checkbox"/> DXI24SP102				
		Cross Tee 1	2	<input type="checkbox"/> DXI524				
		Cross Tee 2	1	<input type="checkbox"/> DXI524				
		Cross Tee 3	2	<input type="checkbox"/> DXT2822				
	DONN® DX®	Main Tee			<input type="checkbox"/> DX24SP102		<input type="checkbox"/> DX24SP102	
		Cross Tee 1			2	<input type="checkbox"/> DX524	2	<input type="checkbox"/> DX524
		Cross Tee 2			1	<input type="checkbox"/> DX524	1	<input type="checkbox"/> DX524
		Cross Tee 3			2	<input type="checkbox"/> DX2816	2	<input type="checkbox"/> DX2816

Suspension System Estimator

	Length	Sq. Ft.	Main Tee Usage Per Sq. Ft.	Cross Tee 1 Usage Per Sq. Ft.	Cross Tee 2 Usage Per Sq. Ft.	Cross Tee 3 Usage Per Sq. Ft.
System Module	60"	25	0.20	0.40	0.20	0.19

Note: Multiply the ceiling area (SF) by the Usage Factor (UF). This calculation will determine lineal footage of suspension system components required. Please refer to page 11 for stabilizer bar usage.









On-Module Channel Spacing

System 433

5' Ceiling Module

4" Channel
28" x 60" Field Panel

Selector

Channel Width	Ceiling Module	On-Center Channel Spacing	Field Panels	Panel Edge	Suspension System
4"	5' (60")	5' (60")	HALCYON™ CLIMAPLUS™ 28" x 60" x 1"	FL 	DXT™, DXI™
				SL 	DX®
				SQ 	DX®
			MARS™ CLIMAPLUS™ 28" x 60" x 3/4"	FLB 	DXT™, DXI™
				SLT 	DX®
				SQ 	DX®
			MARS™ CLIMAPLUS™ High-NRC 28" x 60" x 7/8"	FLB 	DXT™, DXI™
				SLT 	DX®
				SQ 	DX®

Module Layout

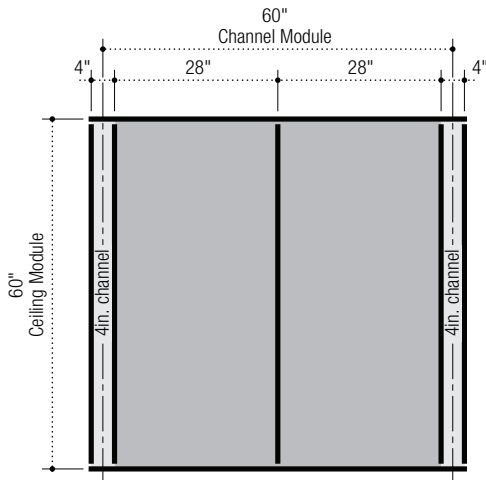

Panel Layout

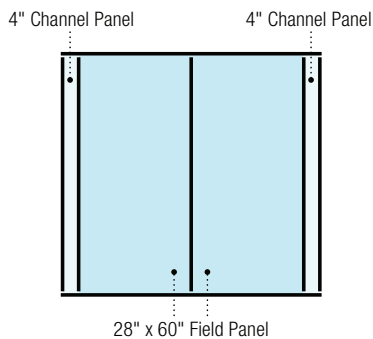

Suspension System Layout

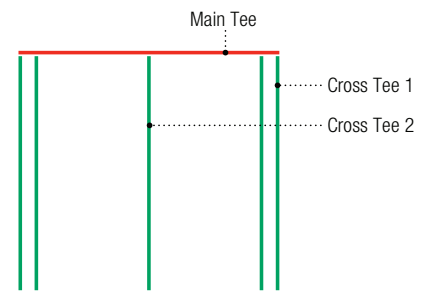

Order Information
System 433

5' Ceiling Module

4" Channel
28" x 60" Field Panel

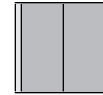

Step 1. Select Panels

Step 2. Select Edge for Panels

			FL/FLB		SL/SLT		SQ	
			Edge	Item No.	Edge	Item No.	Edge	Item No.
Field Panels	HALCYON™ CLIMAPLUS™	28" x 60" x 1"	FL	<input type="checkbox"/> 97355	SL	<input type="checkbox"/> 97450	SQ	<input type="checkbox"/> 97420
	MARS™ CLIMAPLUS™	28" x 60" x 3/4"	FLB	<input type="checkbox"/> 86580	SLT	<input type="checkbox"/> 86560	SQ	<input type="checkbox"/> 86533
	MARS™ CLIMAPLUS™ High-NRC	28" x 60" x 7/8"	FLB	<input type="checkbox"/> 86493	SLT	<input type="checkbox"/> 86461	SQ	<input type="checkbox"/> 86424

Channel Panels	MARS™ CLIMAPLUS™	4" x 60" x 3/4"	FLB	<input type="checkbox"/> 86569	SLT	<input type="checkbox"/> 86541	SQ	<input type="checkbox"/> 86515
	MARS™ CLIMAPLUS™ High-NRC	4" x 60" x 7/8"	FLB	<input type="checkbox"/> 86476	SLT	<input type="checkbox"/> 86441	SQ	<input type="checkbox"/> 86403

Step 3. Select Corresponding Grid for Selected Panels

			Qty	Item No.	Qty	Item No.	Qty	Item No.
Suspension Systems	CENTRICITEE™ DXT™	Main Tee		<input type="checkbox"/> DXT24SP102				
		Cross Tee 1	2	<input type="checkbox"/> DXT524				
		Cross Tee 2	1	<input type="checkbox"/> DXT524				
	IDENTITEE™ DXI™	Main Tee		<input type="checkbox"/> DXI24SP102				
		Cross Tee 1	2	<input type="checkbox"/> DXI524				
		Cross Tee 2	1	<input type="checkbox"/> DXI524				
	DONN® DX®	Main Tee				<input type="checkbox"/> DX24SP102		<input type="checkbox"/> DX24SP102
		Cross Tee 1			2	<input type="checkbox"/> DX524	2	<input type="checkbox"/> DX524
		Cross Tee 2			1	<input type="checkbox"/> DX524	1	<input type="checkbox"/> DX524

Suspension System Estimator

	Length	Sq. Ft.	Main Tee Usage Per Sq. Ft.	Cross Tee 1 Usage Per Sq. Ft.	Cross Tee 2 Usage Per Sq. Ft.	
System Module	60"	25	0.20	0.40	0.20	

Note: Multiply the ceiling area (SF) by the Usage Factor (UF). This calculation will determine lineal footage of suspension system components required. Please refer to page 11 for stabilizer bar usage.

On-Module Channel Spacing









4' Ceiling Module

4" Channel

System 524

56" x 30" Field Panel

Selector

Channel Width	Ceiling Module	On-Center Channel Spacing	Field Panels	Panel Edge	Suspension System
4"	5' (60")	5' (60")	HALCYON™ CLIMAPLUS™ 56" x 30" x 1"	FL 	DXT™, DXI™
				SL 	DX®
				SQ 	DX®
			MARS™ CLIMAPLUS™ 56" x 30" x 3/4"	FLB 	DXT™, DXI™
				SLT 	DX®
				SQ 	DX®
			MARS™ CLIMAPLUS™ High-NRC 56" x 30" x 7/8"	FLB 	DXT™, DXI™
				SLT 	DX®
				SQ 	DX®

Module Layout

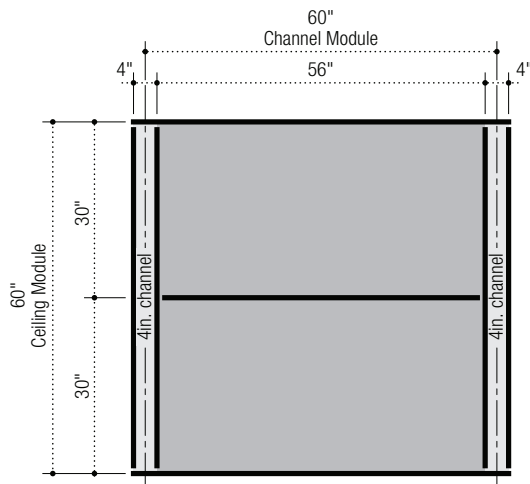

Panel Layout

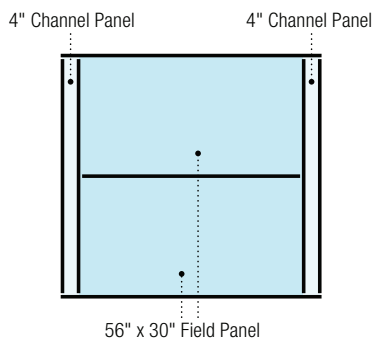

Suspension System Layout

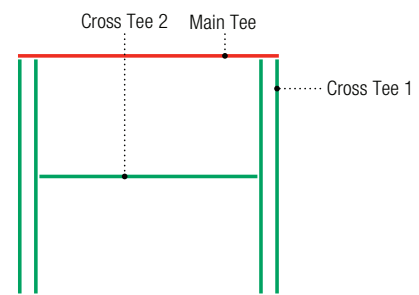

Order Information
System 524

5' Ceiling Module

4" Channel
56" x 30" Field Panel



Step 1. Select Panels

Step 2. Select Edge for Panels

			FL/FLB		SL/SLT		SQ	
			Edge	Item No.	Edge	Item No.	Edge	Item No.
Field Panels	HALCYON™ CLIMAPLUS™	56" x 30" x 1"	FL	<input type="checkbox"/> 97473	SL	<input type="checkbox"/> 97453	SQ	<input type="checkbox"/> 97423
	MARS™ CLIMAPLUS™	56" x 30" x 3/4"	FLB	<input type="checkbox"/> 86583	SLT	<input type="checkbox"/> 86563	SQ	<input type="checkbox"/> 86535
	MARS™ CLIMAPLUS™ High-NRC	56" x 30" x 7/8"	FLB	<input type="checkbox"/> 86496	SLT	<input type="checkbox"/> 86465	SQ	<input type="checkbox"/> 86428

Channel Panels	MARS™ CLIMAPLUS™	4" x 60" x 3/4"	FLB	<input type="checkbox"/> 86569	SLT	<input type="checkbox"/> 86541	SQ	<input type="checkbox"/> 86515
	MARS™ CLIMAPLUS™ High-NRC	4" x 60" x 7/8"	FLB	<input type="checkbox"/> 86476	SLT	<input type="checkbox"/> 86441	SQ	<input type="checkbox"/> 86403

Step 3. Select Corresponding Grid for Selected Panels

			Qty	Item No.	Qty	Item No.	Qty	Item No.
Suspension Systems	CENTRICITEE™ DXT™	Main Tee		<input type="checkbox"/> DXT24SP102				
		Cross Tee 1	2	<input type="checkbox"/> DXT524				
		Cross Tee 2	1	<input type="checkbox"/> DXT5622				
	IDENTITEE™ DXI™	Main Tee		<input type="checkbox"/> DXI24SP102				
		Cross Tee 1	2	<input type="checkbox"/> DXI524				
		Cross Tee 2	1	<input type="checkbox"/> DXI5624				
	DONN® DX®	Main Tee			<input type="checkbox"/> DX24SP102		<input type="checkbox"/> DX24SP102	
		Cross Tee 1			2	<input type="checkbox"/> DX524	2	<input type="checkbox"/> DX524
		Cross Tee 2			1	<input type="checkbox"/> DX5616	1	<input type="checkbox"/> DX5616

Suspension System Estimator

	Length	Sq. Ft.	Main Tee Usage Per Sq. Ft.	Cross Tee 1 Usage Per Sq. Ft.	Cross Tee 2 Usage Per Sq. Ft.	
System Module	60"	25	0.20	0.40	0.19	

Note: Multiply the ceiling area (SF) by the Usage Factor (UF). This calculation will determine lineal footage of suspension system components required. Please refer to page 11 for stabilizer bar usage.

On-Module Channel Spacing

4' Ceiling Module



4" Channel

System 795

46" x 48" Field Panel

48" x 48" Field Panel

Selector

Channel Width	Ceiling Module	On-Center Channel Spacing	Field Panels	Panel Edge	Suspension System
4"	4' (48")	12' (144")	HALCYON™ CLIMAPLUS™ 46" x 48" x 1" 48" x 48" x 1"	FL 	DXT™, DXI™
				SL 	DX®
				SQ 	DX®

Module Layout

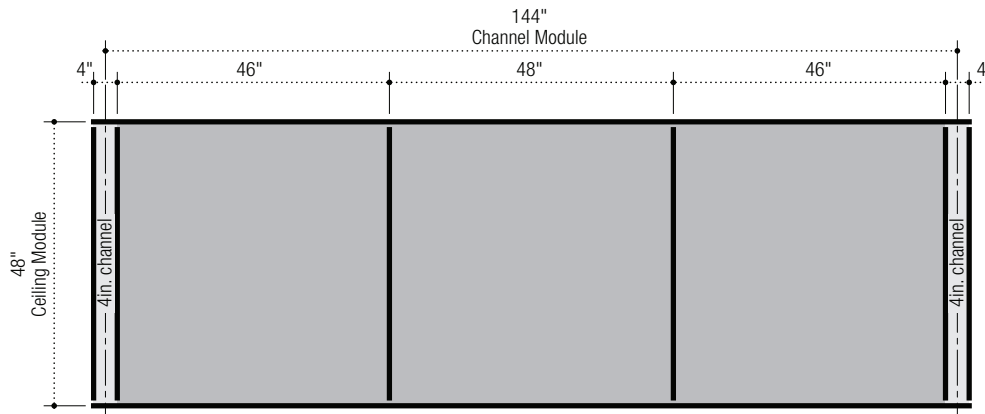

Panel Layout

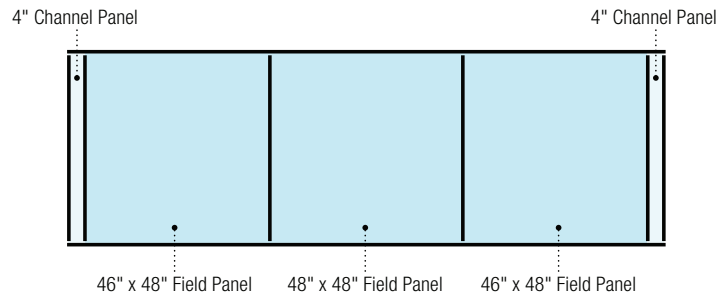

Suspension System Layout

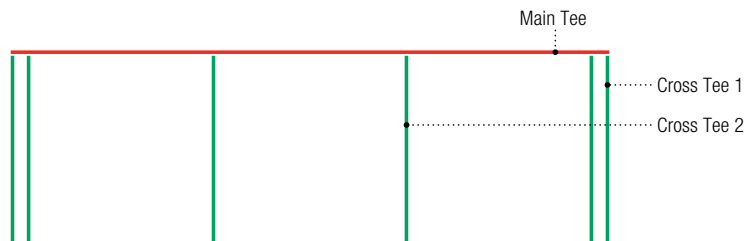

Order Information

System 795

4' Ceiling Module

4" Channel

46" x 48" Field Panel

48" x 48" Field Panel



Step 1. Select Panels

Step 2. Select Edge for Panels

			FL/FLB		SL/SLT		SQ	
			Edge	Item No.	Edge	Item No.	Edge	Item No.
Field Panels	HALCYON™ CLIMAPLUS™	46" x 48" x 1"	FL	<input type="checkbox"/> 97477	SL	<input type="checkbox"/> 97457	SQ	<input type="checkbox"/> 97427

Step 3. Select Corresponding Grid for Selected Panels

			Qty	Item No.	Qty	Item No.	Qty	Item No.
Suspension Systems	CENTRICITEE™ DXT™	Main Tee		<input type="checkbox"/> DXT24SP104				
		Cross Tee 1	2	<input type="checkbox"/> DXT424				
		Cross Tee 2	2	<input type="checkbox"/> DXT424				
	IDENTITEE™ DXI™	Main Tee		<input type="checkbox"/> DXI24SP104				
		Cross Tee 1	2	<input type="checkbox"/> DXI424				
		Cross Tee 2	2	<input type="checkbox"/> DXI424				
	DONN® DX®	Main Tee			<input type="checkbox"/> DX24SP104		<input type="checkbox"/> DX24SP104	
		Cross Tee 1			2	<input type="checkbox"/> DX422	2	<input type="checkbox"/> DX422
		Cross Tee 2			2	<input type="checkbox"/> DX422	2	<input type="checkbox"/> DX422

Suspension System Estimator

	Length	Sq. Ft.	Main Tee Usage Per Sq. Ft.	Cross Tee 1 Usage Per Sq. Ft.	Cross Tee 2 Usage Per Sq. Ft.	
System Module	144"	48	0.25	0.17	0.17	

Note: Multiply the ceiling area (SF) by the Usage Factor (UF). This calculation will determine lineal footage of suspension system components required. Please refer to page 11 for stabilizer bar usage.

On-Module Channel Spacing



4' Ceiling Module

6" Channel

System 346

42" x 48" Field Panel

Selector

Channel Width	Ceiling Module	On-Center Channel Spacing	Field Panels	Panel Edge	Suspension System
6"	4' (48")	4' (48")	HALCYON™ CLIMAPLUS™ 42" x 48" x 1"	FL 	DXT™, DXI™
				SL 	DX®
				SQ 	DX®

Module Layout

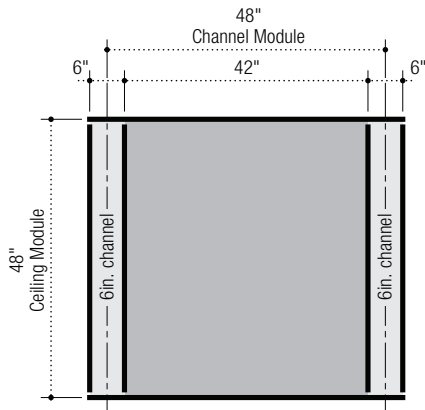

Panel Layout

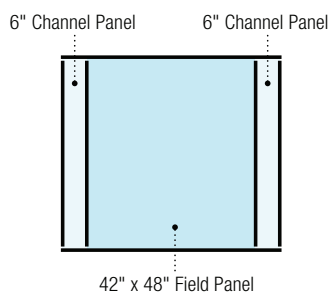

Suspension System Layout

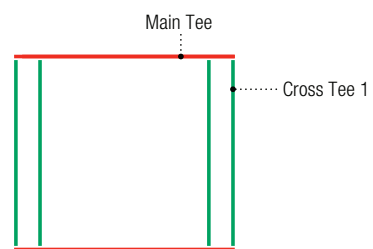

Order Information
System 346

4' Ceiling Module

6" Channel
42" x 48" Field Panel



Step 1. Select Panels

Step 2. Select Edge for Panels

			FL/FLB		SL/SLT		SQ	
			Edge	Item No.	Edge	Item No.	Edge	Item No.
Field Panels	HALCYON™ CLIMAPLUS™	42" x 48" x 1"	FL	<input type="checkbox"/> 98343	SL	<input type="checkbox"/> 97454	SQ	<input type="checkbox"/> 97424
Channel Panels	HALCYON™ CLIMAPLUS™	6" x 48" x 1"	FL	<input type="checkbox"/> 98198	SL	<input type="checkbox"/> 99271	SQ	<input type="checkbox"/> 97227
	PANZ® Metal Panels, Solid	6" x 48"	FL	<input type="checkbox"/> 256820	SL	<input type="checkbox"/> 256819	SQ	<input type="checkbox"/> 256768
	PANZ® Metal Panels, Perf C116	6" x 48"	FL	<input type="checkbox"/> 256062	SL	<input type="checkbox"/> 257248	SQ	<input type="checkbox"/> 256397
	PANZ® Metal Panels, Perf C116D	6" x 48"	FL	<input type="checkbox"/> 257585	SL	<input type="checkbox"/> 257584	SQ	<input type="checkbox"/> 257406

Step 3. Select Corresponding Grid for Selected Panels

			Qty	Item No.	Qty	Item No.	Qty	Item No.
Suspension Systems	CENTRICITEE™ DXT™	Main Tee		<input type="checkbox"/> DXT24				
		Cross Tee 1	2	<input type="checkbox"/> DXT424				
	IDENTITEE™ DXI™	Main Tee		<input type="checkbox"/> DXI24				
		Cross Tee 1	2	<input type="checkbox"/> DXI424				
	DONN® DX®	Main Tee				<input type="checkbox"/> DX/DXL24		<input type="checkbox"/> DX/DXL24
		Cross Tee 1			2	<input type="checkbox"/> DX422	2	<input type="checkbox"/> DX422

Suspension System Estimator

	Length	Sq. Ft.	Main Tee Usage Per Sq. Ft.	Cross Tee 1 Usage Per Sq. Ft.	
System Module	48"	16	0.25	0.50	

Note: Multiply the ceiling area (SF) by the Usage Factor (UF). This calculation will determine lineal footage of suspension system components required. Please refer to page 11 for stabilizer bar usage.

On-Module Channel Spacing









4' Ceiling Module

6" Channel

System 727

42" x 24" Field Panel

Selector

Channel Width	Ceiling Module	On-Center Channel Spacing	Field Panels	Panel Edge	Suspension System
6"	4' (48")	4' (48")	HALCYON™ CLIMAPLUS™ 42" x 24" x 1"	FL 	DXT™, DXI™
				SL 	DX®
				SQ 	DX®
			MARS™ CLIMAPLUS™ 42" x 24" x 3/4"	FLB 	DXT™, DXI™
				SLT 	DX®
				SQ 	DX®
			MARS™ CLIMAPLUS™ High-NRC 42" x 24" x 7/8"	FLB 	DXT™, DXI™
				SLT 	DX®
				SQ 	DX®

Module Layout

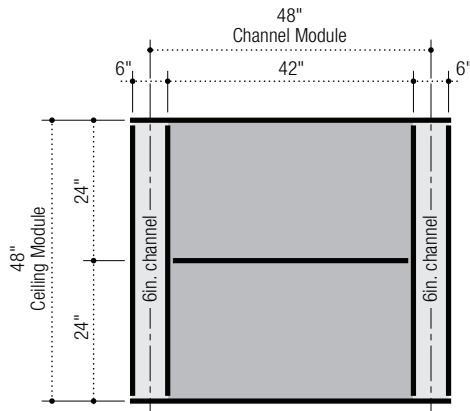

Panel Layout

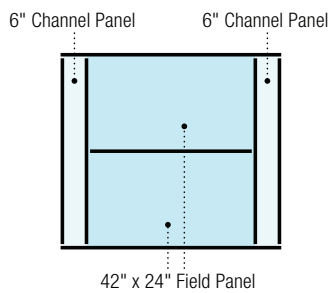

Suspension System Layout

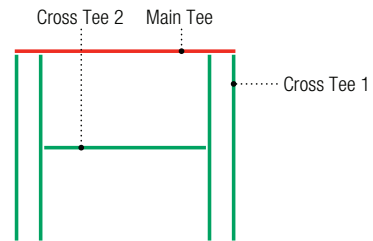

Order Information
System 727

4' Ceiling Module

6" Channel
42" x 24" Field Panel



Step 1. Select Panels

Step 2. Select Edge for Panels

			FL/FLB		SL/SLT		SQ	
			Edge	Item No.	Edge	Item No.	Edge	Item No.
Field Panels	HALCYON™ CLIMAPLUS™	42" x 24" x 1"	FL	□ 98196	SL	□ 97443	SQ	□ 97277
	MARS™ CLIMAPLUS™	42" x 24" x 3/4"	FLB	□ 86577	SLT	□ 86555	SQ	□ 86527
	MARS™ CLIMAPLUS™ High-NRC	42" x 24" x 7/8"	FLB	□ 86488	SLT	□ 86456	SQ	□ 86419

Channel Panels	HALCYON™ CLIMAPLUS™	6" x 48" x 1"	FL	□ 98198	SL	□ 99271	SQ	□ 97227
	MARS™ CLIMAPLUS™	6" x 48" x 3/4"	FLB	□ 88887	SLT	□ 86542	SQ	□ 86325
	MARS™ CLIMAPLUS™ High-NRC	6" x 48" x 7/8"	FLB	□ 86331	SLT	□ 86442	SQ	□ 86404
	PANZ® Metal Panels, Solid	6" x 48"	FL	□ 256820	SL	□ 256819	SQ	□ 256768
	PANZ® Metal Panels, Perf C116	6" x 48"	FL	□ 256062	SL	□ 257248	SQ	□ 256397
	PANZ® Metal Panels, Perf C116D	6" x 48"	FL	□ 257585	SL	□ 257584	SQ	□ 257406

Step 3. Select Corresponding Grid for Selected Panels

			Qty	Item No.	Qty	Item No.	Qty	Item No.
Suspension Systems	CENTRICITEE™ DXT™	Main Tee		□ DXT24				
		Cross Tee 1	2	□ DXT424				
		Cross Tee 2	1	□ DXT4222				
	IDENTITEE™ DXI™	Main Tee		□ DXI24				
		Cross Tee 1	2	□ DXI424				
		Cross Tee 2	1	□ DXI4224				
	DONN® DX®	Main Tee				□ DX/DXL24		□ DX/DXL24
		Cross Tee 1			2	□ DX422	2	□ DX422
		Cross Tee 2			1	□ DX4216	1	□ DX4216

Suspension System Estimator

	Length	Sq. Ft.	Main Tee Usage Per Sq. Ft.	Cross Tee 1 Usage Per Sq. Ft.	Cross Tee 2 Usage Per Sq. Ft.	
System Module	48"	16	0.25	0.50	0.22	

Note: Multiply the ceiling area (SF) by the Usage Factor (UF). This calculation will determine lineal footage of suspension system components required. Please refer to page 11 for stabilizer bar usage.

On-Module Channel Spacing









4' Ceiling Module

6" Channel

System 838

21" x 24" Field Panel

Selector

Channel Width	Ceiling Module	On-Center Channel Spacing	Field Panels	Panel Edge	Suspension System
6"	4' (48")	4' (48")	HALCYON™ CLIMAPLUS™ 21" x 24" x 1"	FL 	DXT™, DXI™
				SL 	DX®
				SQ 	DX®, DXT™
			MARS™ CLIMAPLUS™ 21" x 24" x 3/4"	FLB 	DXT™, DXI™
				SLT 	DX®
				SQ 	DX®, DXT™
			MARS™ CLIMAPLUS™ High-NRC 21" x 24" x 7/8"	FLB 	DXT™, DXI™
				SLT 	DX®
				SQ 	DX®, DXT™

Module Layout

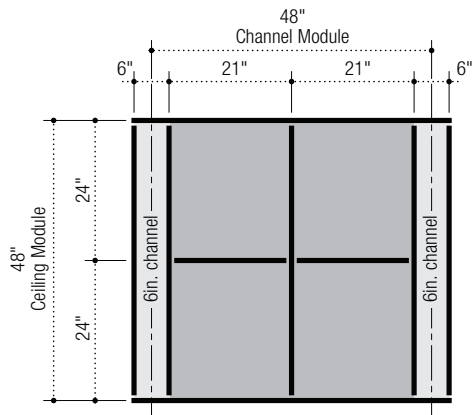

Panel Layout

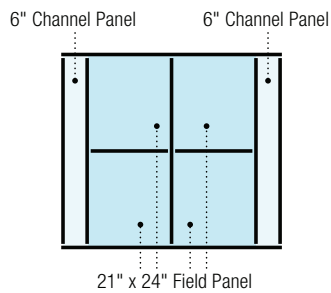

Suspension System Layout

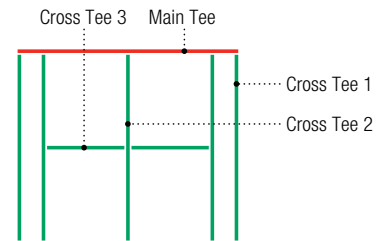

Order Information
System 838

4' Ceiling Module

6" Channel
21" x 24" Field Panel



Step 1. Select Panels

Step 2. Select Edge for Panels

			FL/FLB		SL/SLT		SQ	
			Edge	Item No.	Edge	Item No.	Edge	Item No.
Field Panels	HALCYON™ CLIMAPLUS™	21" x 24" x 1"	FL	□ 98195	SL	□ 98220	SQ	□ 97411
	MARS™ CLIMAPLUS™	21" x 24" x 3/4"	FLB	□ 88840	SLT	□ 86550	SQ	□ 86522
	MARS™ CLIMAPLUS™ High-NRC	21" x 24" x 7/8"	FLB	□ 86483	SLT	□ 86451	SQ	□ 86414

Channel Panels	HALCYON™ CLIMAPLUS™	6" x 48" x 1"	FL	□ 98198	SL	□ 99271	SQ	□ 97227
	MARS™ CLIMAPLUS™	6" x 48" x 3/4"	FLB	□ 88887	SLT	□ 86542	SQ	□ 86325
	MARS™ CLIMAPLUS™ High-NRC	6" x 48" x 7/8"	FLB	□ 86331	SLT	□ 86442	SQ	□ 86404
	PANZ® Metal Panels, Solid	6" x 48"	FL	□ 256820	SL	□ 256819	SQ	□ 256768
	PANZ® Metal Panels, Perf C116	6" x 48"	FL	□ 256062	SL	□ 257248	SQ	□ 256397
	PANZ® Metal Panels, Perf C116D	6" x 48"	FL	□ 257585	SL	□ 257584	SQ	□ 257406

Step 3. Select Corresponding Grid for Selected Panels

			Qty	Item No.	Qty	Item No.	Qty	Item No.
Suspension Systems	CENTRICITEE™ DXT™	Main Tee		□ DXT24SP105				□ DXT24SP105
		Cross Tee 1	2	□ DXT424			2	□ DXT424
		Cross Tee 2	1	□ DXT424			1	□ DXT424
		Cross Tee 3	2	□ DXT2122			2	□ DXT2122
	IDENTITEE™ DXI™	Main Tee		□ DXI24SP105				
		Cross Tee 1	2	□ DXI424				
		Cross Tee 2	1	□ DXI424				
		Cross Tee 3	2	□ DXI2122				
	DONN® DX®	Main Tee				□ DX24SP105		□ DX24SP105
		Cross Tee 1			2	□ DX422	2	□ DX422
		Cross Tee 2			1	□ DX422	1	□ DX
		Cross Tee 3			2	□ DX2116	2	□ DX2116

Suspension System Estimator

	Length	Sq. Ft.	Main Tee Usage Per Sq. Ft.	Cross Tee 1 Usage Per Sq. Ft.	Cross Tee 2 Usage Per Sq. Ft.	Cross Tee 3 Usage Per Sq. Ft.
System Module	48"	16	0.25	0.50	0.25	0.22

Note: Multiply the ceiling area (SF) by the Usage Factor (UF). This calculation will determine lineal footage of suspension system components required. Please refer to page 11 for stabilizer bar usage.

On-Module Channel Spacing









4' Ceiling Module

6" Channel

System 646

21" x 48" Field Panel

Selector

Channel Width	Ceiling Module	On-Center Channel Spacing	Field Panels	Panel Edge	Suspension System
4"	4' (48")	4' (48")	HALCYON™ CLIMAPLUS™ 21" x 48" x 1"	FL 	DXT™, DXI™
				SL 	DX®
				SQ 	DX®
			MARS™ CLIMAPLUS™ 21" x 48 x 3/4"	FLB 	DXT™, DXI™
				SLT 	DX®
				SQ 	DX®
			MARS™ CLIMAPLUS™ High-NRC 21" x 48" x 7/8"	FLB 	DXT™, DXI™
				SLT 	DX®
				SQ 	DX®

Module Layout

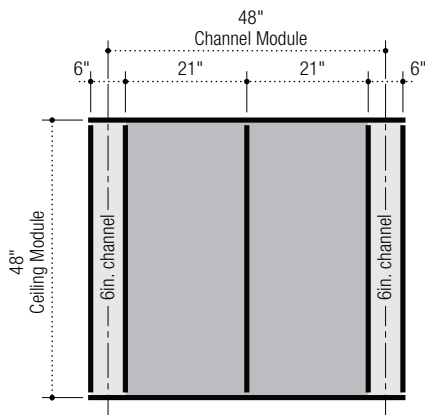

Panel Layout

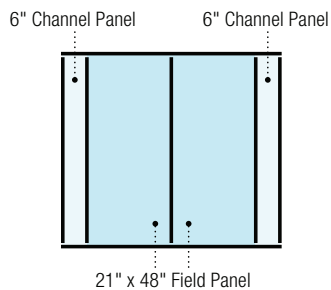

Suspension System Layout

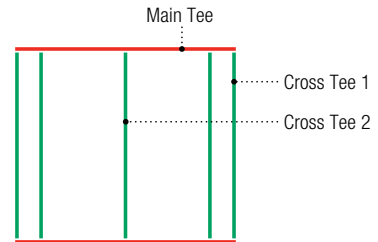

Order Information
System 646

4' Ceiling Module

6" Channel
21" x 48" Field Panel



Step 1. Select Panels

Step 2. Select Edge for Panels

			FL/FLB		SL/SLT		SQ	
			Edge	Item No.	Edge	Item No.	Edge	Item No.
Field Panels	HALCYON™ CLIMAPLUS™	21" x 48" x 1"	FL	<input type="checkbox"/> 97466	SL	<input type="checkbox"/> 97439	SQ	<input type="checkbox"/> 97412
	MARS™ CLIMAPLUS™	21" x 48" x 3/4"	FLB	<input type="checkbox"/> 86573	SLT	<input type="checkbox"/> 86551	SQ	<input type="checkbox"/> 86523
	MARS™ CLIMAPLUS™ High-NRC	21" x 48" x 7/8"	FLB	<input type="checkbox"/> 86484	SLT	<input type="checkbox"/> 86452	SQ	<input type="checkbox"/> 86415

Channel Panels	HALCYON™ CLIMAPLUS™	6" x 48" x 1"	FL	<input type="checkbox"/> 98198	SL	<input type="checkbox"/> 99271	SQ	<input type="checkbox"/> 97227
	MARS™ CLIMAPLUS™	6" x 48" x 3/4"	FLB	<input type="checkbox"/> 88887	SLT	<input type="checkbox"/> 86542	SQ	<input type="checkbox"/> 86325
	MARS™ CLIMAPLUS™ High-NRC	6" x 48" x 7/8"	FLB	<input type="checkbox"/> 86331	SLT	<input type="checkbox"/> 86442	SQ	<input type="checkbox"/> 86404
	PANZ® Metal Panels, Solid	6" x 48"	FL	<input type="checkbox"/> 256820	SL	<input type="checkbox"/> 256819	SQ	<input type="checkbox"/> 256768
	PANZ® Metal Panels, Perf C116	6" x 48"	FL	<input type="checkbox"/> 256062	SL	<input type="checkbox"/> 257248	SQ	<input type="checkbox"/> 256397
	PANZ® Metal Panels, Perf C116D	6" x 48"	FL	<input type="checkbox"/> 257585	SL	<input type="checkbox"/> 257584	SQ	<input type="checkbox"/> 257406

Step 3. Select Corresponding Grid for Selected Panels

			Qty	Item No.	Qty	Item No.	Qty	Item No.
Suspension Systems	CENTRICITEE™ DXT™	Main Tee		<input type="checkbox"/> DXT24SP105				
		Cross Tee 1	2	<input type="checkbox"/> DXT424				
		Cross Tee 2	1	<input type="checkbox"/> DXT424				
	IDENTITEE™ DXI™	Main Tee		<input type="checkbox"/> DXI24SP105				
		Cross Tee 1	2	<input type="checkbox"/> DXI424				
		Cross Tee 2	1	<input type="checkbox"/> DXI424				
	DONN® DX®	Main Tee			<input type="checkbox"/> DX24SP105		<input type="checkbox"/> DX24SP105	
		Cross Tee 1			2	<input type="checkbox"/> DX422	2	<input type="checkbox"/> DX422
		Cross Tee 2			1	<input type="checkbox"/> DX422	1	<input type="checkbox"/> DX422

Suspension System Estimator

	Length	Sq. Ft.	Main Tee Usage Per Sq. Ft.	Cross Tee 1 Usage Per Sq. Ft.	Cross Tee 2 Usage Per Sq. Ft.	
System Module	48"	16	0.25	0.50	0.25	

Note: Multiply the ceiling area (SF) by the Usage Factor (UF). This calculation will determine lineal footage of suspension system components required. Please refer to page 11 for stabilizer bar usage.

On-Module Channel Spacing



4' Ceiling Module

6" Channel

System 363

54" x 48" Field Panel

Selector

Channel Width	Ceiling Module	On-Center Channel Spacing	Field Panels	Panel Edge	Suspension System
6"	4' (48")	5' (60")	HALCYON™ CLIMAPLUS™ 54" x 48" x 1"	FL 	DXT™, DXI™
				SL 	DX®
				SQ 	DX®

Module Layout

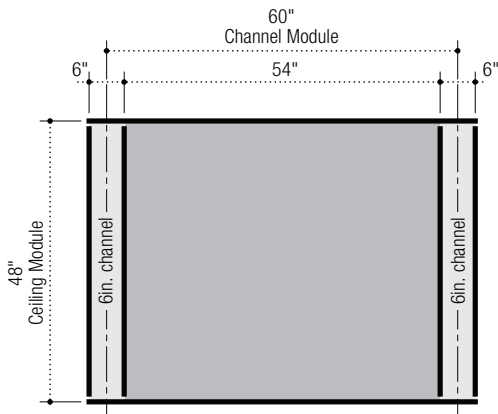

Panel Layout

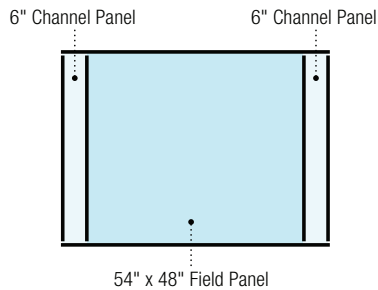

Suspension System Layout

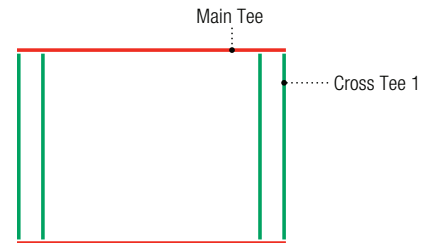

Order Information
System 363

4' Ceiling Module

6" Channel
54" x 48" Field Panel



Step 1. Select Panels

Step 2. Select Edge for Panels

			FL/FLB		SL/SLT		SQ	
			Edge	Item No.	Edge	Item No.	Edge	Item No.
Field Panels	HALCYON™ CLIMAPLUS™	54" x 48" x 1"	FL	<input type="checkbox"/> 98344	SL	<input type="checkbox"/> 97458	SQ	<input type="checkbox"/> 97428

			FL	Item No.	SL	Item No.	SQ	Item No.
Channel Panels	HALCYON™ CLIMAPLUS™	6" x 48" x 1"	FL	<input type="checkbox"/> 98198	SL	<input type="checkbox"/> 99271	SQ	<input type="checkbox"/> 97227
	PANZ® Metal Panels, Solid	6" x 48"	FL	<input type="checkbox"/> 256820	SL	<input type="checkbox"/> 256819	SQ	<input type="checkbox"/> 256768
	PANZ® Metal Panels, Perf C116	6" x 48"	FL	<input type="checkbox"/> 256062	SL	<input type="checkbox"/> 257248	SQ	<input type="checkbox"/> 256397
	PANZ® Metal Panels, Perf C116D	6" x 48"	FL	<input type="checkbox"/> 257585	SL	<input type="checkbox"/> 257584	SQ	<input type="checkbox"/> 257406

Step 3. Select Corresponding Grid for Selected Panels

			Qty	Item No.	Qty	Item No.	Qty	Item No.
Suspension Systems	CENTRICITEE™ DXT™	Main Tee		<input type="checkbox"/> DXT24				
		Cross Tee 1	2	<input type="checkbox"/> DXT424				
	IDENTITEE™ DXI™	Main Tee		<input type="checkbox"/> DXI24				
		Cross Tee 1	2	<input type="checkbox"/> DXI424				
	DONN® DX®	Main Tee				<input type="checkbox"/> DX/DXL24		<input type="checkbox"/> DX/DXL24
		Cross Tee 1			2	<input type="checkbox"/> DX422	2	<input type="checkbox"/> DX422

Suspension System Estimator

	Length	Sq. Ft.	Main Tee Usage Per Sq. Ft.	Cross Tee 1 Usage Per Sq. Ft.	
System Module	60"	20	0.25	0.40	

Note: Multiply the ceiling area (SF) by the Usage Factor (UF). This calculation will determine lineal footage of suspension system components required. Please refer to page 11 for stabilizer bar usage.

On-Module Channel Spacing









5' Ceiling Module

6" Channel

System 753

54" x 20" Field Panel

Selector

Channel Width	Ceiling Module	On-Center Channel Spacing	Field Panels	Panel Edge	Suspension System
6"	5' (60")	5' (60")	HALCYON™ CLIMAPLUS™ 54" x 20" x 1"	FL 	DXT™, DXI™
				SL 	DX®
				SQ 	DX®
			MARS™ CLIMAPLUS™ 54" x 20" x 3/4"	FLB 	DXT™, DXI™
				SLT 	DX®
				SQ 	DX®
			MARS™ CLIMAPLUS™ High-NRC 54" x 20" x 7/8"	FLB 	DXT™, DXI™
				SLT 	DX®
				SQ 	DX®

Module Layout

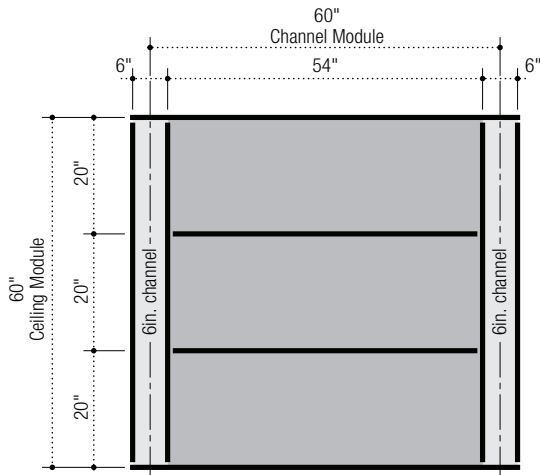

Panel Layout

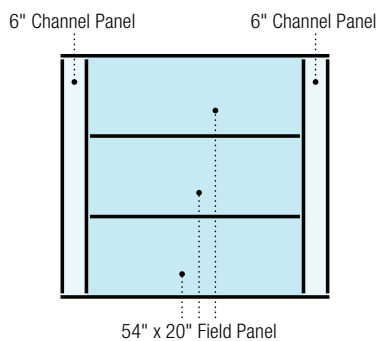

Suspension System Layout

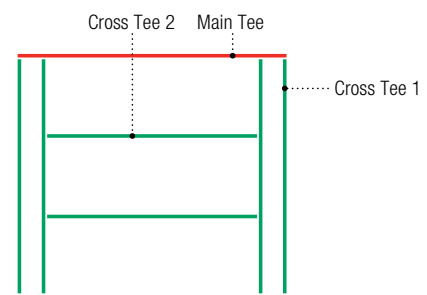

Order Information
System 753

5' Ceiling Module

6" Channel
54" x 20" Field Panel



Step 1. Select Panels

Step 2. Select Edge for Panels

			FL/FLB		SL/SLT		SQ	
			Edge	Item No.	Edge	Item No.	Edge	Item No.
Field Panels	HALCYON™ CLIMAPLUS™	54" x 20" x 1"	FL	<input type="checkbox"/> 98360	SL	<input type="checkbox"/> 97436	SQ	<input type="checkbox"/> 97407
	MARS™ CLIMAPLUS™	54" x 20" x 3/4"	FLB	<input type="checkbox"/> 88845	SLT	<input type="checkbox"/> 86547	SQ	<input type="checkbox"/> 86519
	MARS™ CLIMAPLUS™ High-NRC	54" x 20" x 7/8"	FLB	<input type="checkbox"/> 86479	SLT	<input type="checkbox"/> 86447	SQ	<input type="checkbox"/> 86410

Channel Panels	HALCYON™ CLIMAPLUS™	6" x 60" x 1"	FL	<input type="checkbox"/> 98199	SL	<input type="checkbox"/> 99272	SQ	<input type="checkbox"/> 97228
	MARS™ CLIMAPLUS™	6" x 60" x 3/4"	FLB	<input type="checkbox"/> 86835	SLT	<input type="checkbox"/> 86543	SQ	<input type="checkbox"/> 86507
	MARS™ CLIMAPLUS™ High-NRC	6" x 60" x 7/8"	FLB	<input type="checkbox"/> 86333	SLT	<input type="checkbox"/> 86443	SQ	<input type="checkbox"/> 86145
	PANZ® Metal Panels, Solid	6" x 60"	FL	<input type="checkbox"/> 258036	SL	<input type="checkbox"/> 257972	SQ	<input type="checkbox"/> 257586
	PANZ® Metal Panels, Perf C116	6" x 60"	FL	<input type="checkbox"/> 259228	SL	<input type="checkbox"/> 259010	SQ	<input type="checkbox"/> 259009
	PANZ® Metal Panels, Perf C116D	6" x 60"	FL	<input type="checkbox"/> 259353	SL	<input type="checkbox"/> 259344	SQ	<input type="checkbox"/> 259308

Step 3. Select Corresponding Grid for Selected Panels

			Qty	Item No.	Qty	Item No.	Qty	Item No.
Suspension Systems	CENTRICITEE™ DXT™	Main Tee		<input type="checkbox"/> DXT24				
		Cross Tee 1	2	<input type="checkbox"/> DXT524				
	IDENTITEE™ DXI™	Main Tee		<input type="checkbox"/> DXI24				
		Cross Tee 1	2	<input type="checkbox"/> DXI524				
	DONN® DX®	Main Tee				<input type="checkbox"/> DX/DXL24		<input type="checkbox"/> DX/DXL24
		Cross Tee 1			2	<input type="checkbox"/> DX524	2	<input type="checkbox"/> DX524

Suspension System Estimator

	Length	Sq. Ft.	Main Tee Usage Per Sq. Ft.	Cross Tee 1 Usage Per Sq. Ft.	
System Module	60"	20	0.25	0.40	

Note: Multiply the ceiling area (SF) by the Usage Factor (UF). This calculation will determine lineal footage of suspension system components required. Please refer to page 11 for stabilizer bar usage.

On-Module Channel Spacing









5' Ceiling Module

6" Channel

System 856

27" x 30" Field Panel

Selector

Channel Width	Ceiling Module	On-Center Channel Spacing	Field Panels	Panel Edge	Suspension System
6"	5' (60")	5' (60")	HALCYON™ CLIMAPLUS™ 27" x 30" x 1"	FL 	DXT™, DXI™
				SL 	DX®
				SQ 	DX®
			MARS™ CLIMAPLUS™ 27" x 30" x 3/4"	FLB 	DXT™, DXI™
				SLT 	DX®
				SQ 	DX®
			MARS™ CLIMAPLUS™ High-NRC 27" x 30" x 7/8"	FLB 	DXT™, DXI™
				SLT 	DX®
				SQ 	DX®

Module Layout

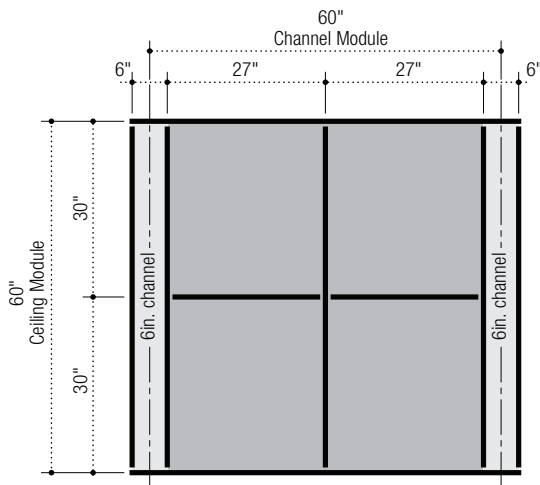

Panel Layout

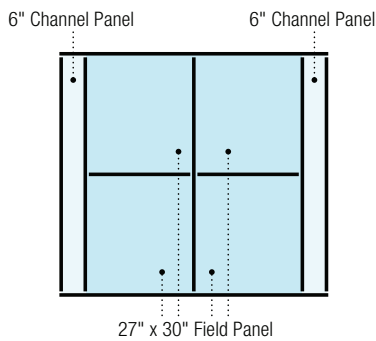

Suspension System Layout

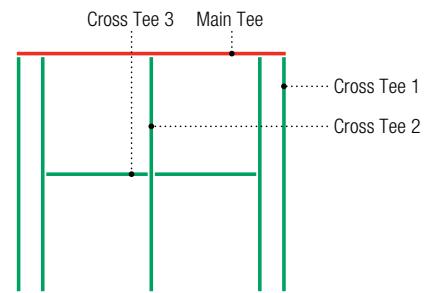

Order Information
System 856

5' Ceiling Module

6" Channel
27" x 30" Field Panel

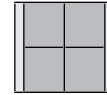

Step 1. Select Panels

Step 2. Select Edge for Panels

			FL/FLB		SL/SLT		SQ	
			Edge	Item No.	Edge	Item No.	Edge	Item No.
Field Panels	HALCYON™ CLIMAPLUS™	27" x 30" x 1"	FL	□ 97333	SL	□ 97477	SQ	□ 97417
	MARS™ CLIMAPLUS™	27" x 30" x 3/4"	FLB	□ 86850	SLT	□ 86557	SQ	□ 86530
	MARS™ CLIMAPLUS™ High-NRC	27" x 30" x 7/8"	FLB	□ 86490	SLT	□ 86458	SQ	□ 86421

Channel Panels	HALCYON™ CLIMAPLUS™	6" x 60" x 1"	FL	□ 98199	SL	□ 99272	SQ	□ 97228
	MARS™ CLIMAPLUS™	6" x 60" x 3/4"	FLB	□ 86835	SLT	□ 86543	SQ	□ 86507
	MARS™ CLIMAPLUS™ High-NRC	6" x 60" x 7/8"	FLB	□ 86333	SLT	□ 86443	SQ	□ 86145
	PANZ® Metal Panels, Solid	6" x 60"	FL	□ 258036	SL	□ 257972	SQ	□ 257586
	PANZ® Metal Panels, Perf C116	6" x 60"	FL	□ 259228	SL	□ 259010	SQ	□ 259009
	PANZ® Metal Panels, Perf C116D	6" x 60"	FL	□ 259353	SL	□ 259344	SQ	□ 259308

Step 3. Select Corresponding Grid for Selected Panels

			Qty	Item No.	Qty	Item No.	Qty	Item No.
Suspension Systems	CENTRICITEE™ DXT™	Main Tee		□ DXT24SP109				
		Cross Tee 1	2	□ DXT524				
		Cross Tee 2	1	□ DXT524				
		Cross Tee 3	2	□ DXT2722				
	IDENTITEE™ DXI™	Main Tee		□ DXI24SP109				
		Cross Tee 1	2	□ DXI524				
		Cross Tee 2	1	□ DXI524				
		Cross Tee 3	2	□ DXI2724				
	DONN® DX®	Main Tee			□ DX24SP109		□ DX24SP109	
		Cross Tee 1			2 □ DX524	2	□ DX524	2 □ DX524
		Cross Tee 2			1 □ DX524	1	□ DX524	1 □ DX524
		Cross Tee 3			2 □ DX2716	2	□ DX2716	2 □ DX2716

Suspension System Estimator

	Length	Sq. Ft.	Main Tee Usage Per Sq. Ft.	Cross Tee 1 Usage Per Sq. Ft.	Cross Tee 2 Usage Per Sq. Ft.	Cross Tee 3 Usage Per Sq. Ft.
System Module	60"	25	0.20	0.40	0.20	0.18

Note: Multiply the ceiling area (SF) by the Usage Factor (UF). This calculation will determine lineal footage of suspension system components required. Please refer to page 11 for stabilizer bar usage.

On-Module Channel Spacing









5' Ceiling Module

6" Channel

System 343

27" x 60" Field Panel

Selector

Channel Width	Ceiling Module	On-Center Channel Spacing	Field Panels	Panel Edge	Suspension System
6"	5' (60")	5' (60")	HALCYON™ CLIMAPLUS™ 27" x 60" x 1"	FL 	DXT™, DXI™
				SL 	DX®
				SQ 	DX®
			MARS™ CLIMAPLUS™ 27" x 60" x 3/4"	FLB 	DXT™, DXI™
				SLT 	DX®
				SQ 	DX®
			MARS™ CLIMAPLUS™ High-NRC 27" x 60" x 7/8"	FLB 	DXT™, DXI™
				SLT 	DX®
				SQ 	DX®

Module Layout

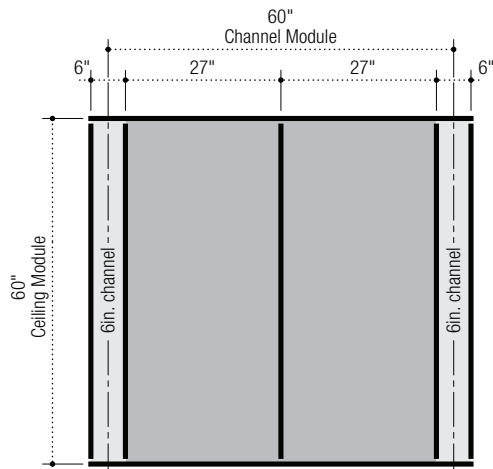

Panel Layout

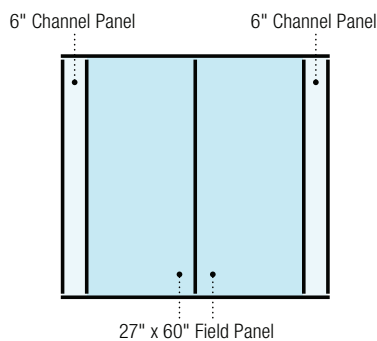

Suspension System Layout

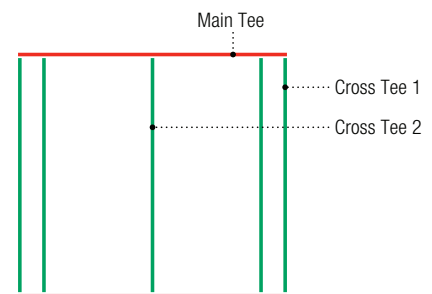

Order Information
System 343

5' Ceiling Module

6" Channel
27" x 60" Field Panel

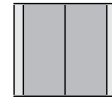

Step 1. Select Panels

Step 2. Select Edge for Panels

			FL/FLB		SL/SLT		SQ	
			Edge	Item No.	Edge	Item No.	Edge	Item No.
Field Panels	HALCYON™ CLIMAPLUS™	27" x 60" x 1"	FL	<input type="checkbox"/> 98440	SL	<input type="checkbox"/> 97448	SQ	<input type="checkbox"/> 97418
	MARS™ CLIMAPLUS™	27" x 60" x 3/4"	FLB	<input type="checkbox"/> 86579	SLT	<input type="checkbox"/> 86558	SQ	<input type="checkbox"/> 86531
	MARS™ CLIMAPLUS™ High-NRC	27" x 60" x 7/8"	FLB	<input type="checkbox"/> 86491	SLT	<input type="checkbox"/> 86460	SQ	<input type="checkbox"/> 86422

Channel Panels	HALCYON™ CLIMAPLUS™	6" x 60" x 1"	FL	<input type="checkbox"/> 98199	SL	<input type="checkbox"/> 99272	SQ	<input type="checkbox"/> 97228
	MARS™ CLIMAPLUS™	6" x 60" x 3/4"	FLB	<input type="checkbox"/> 86835	SLT	<input type="checkbox"/> 86543	SQ	<input type="checkbox"/> 86507
	MARS™ CLIMAPLUS™ High-NRC	6" x 60" x 7/8"	FLB	<input type="checkbox"/> 86333	SLT	<input type="checkbox"/> 86443	SQ	<input type="checkbox"/> 86145
	PANZ® Metal Panels, Solid	6" x 60"	FL	<input type="checkbox"/> 258036	SL	<input type="checkbox"/> 257972	SQ	<input type="checkbox"/> 257586
	PANZ® Metal Panels, Perf C116	6" x 60"	FL	<input type="checkbox"/> 259228	SL	<input type="checkbox"/> 259010	SQ	<input type="checkbox"/> 259009
	PANZ® Metal Panels, Perf C116D	6" x 60"	FL	<input type="checkbox"/> 259353	SL	<input type="checkbox"/> 259344	SQ	<input type="checkbox"/> 259308

Step 3. Select Corresponding Grid for Selected Panels

			Qty	Item No.	Qty	Item No.	Qty	Item No.
Suspension Systems	CENTRICITEE™ DXT™	Main Tee		<input type="checkbox"/> DXT24SP109				
		Cross Tee 1	2	<input type="checkbox"/> DXT524				
		Cross Tee 2	1	<input type="checkbox"/> DXT524				
	IDENTITEE™ DXI™	Main Tee		<input type="checkbox"/> DXI24SP109				
		Cross Tee 1	2	<input type="checkbox"/> DXI524				
		Cross Tee 2	1	<input type="checkbox"/> DXI524				
	DONN® DX®	Main Tee			<input type="checkbox"/> DX24SP109		<input type="checkbox"/> DX24SP109	
		Cross Tee 1			2	<input type="checkbox"/> DX524	2	<input type="checkbox"/> DX524
		Cross Tee 2			1	<input type="checkbox"/> DX524	1	<input type="checkbox"/> DX524

Suspension System Estimator

	Length	Sq. Ft.	Main Tee Usage Per Sq. Ft.	Cross Tee 1 Usage Per Sq. Ft.	Cross Tee 2 Usage Per Sq. Ft.	
System Module	60"	25	0.20	0.40	0.20	

Note: Multiply the ceiling area (SF) by the Usage Factor (UF). This calculation will determine lineal footage of suspension system components required. Please refer to page 11 for stabilizer bar usage.

On-Module Channel Spacing









4' Ceiling Module

4" Channel

System 865

54" x 30" Field Panel

Selector

Channel Width	Ceiling Module	On-Center Channel Spacing	Field Panels	Panel Edge	Suspension System
6"	5' (60")	5' (60")	HALCYON™ CLIMAPLUS™ 54" x 30" x 1"	FL 	DXT™, DXI™
				SL 	DX®
				SQ 	DX®
			MARS™ CLIMAPLUS™ 54" x 30" x 3/4"	FLB 	DXT™, DXI™
				SLT 	DX®
				SQ 	DX®
			MARS™ CLIMAPLUS™ High-NRC 54" x 30" x 7/8"	FLB 	DXT™, DXI™
				SLT 	DX®
				SQ 	DX®

Module Layout

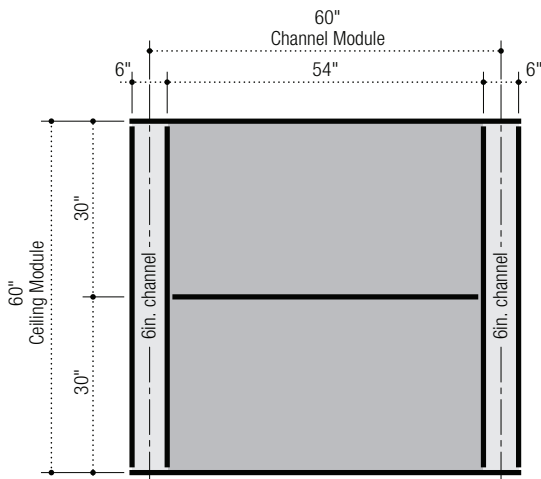

Panel Layout

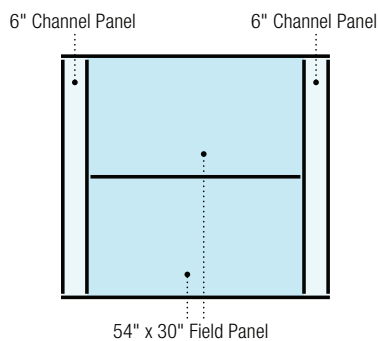

Suspension System Layout

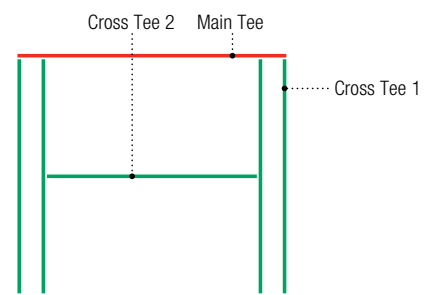

Order Information
System 865

5' Ceiling Module

6" Channel
54" x 30" Field Panel

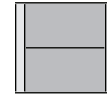

Step 1. Select Panels

Step 2. Select Edge for Panels

			FL/FLB		SL/SLT		SQ	
			Edge	Item No.	Edge	Item No.	Edge	Item No.
Field Panels	HALCYON™ CLIMAPLUS™	54" x 30" x 1"	FL	<input type="checkbox"/> 98359	SL	<input type="checkbox"/> 98337	SQ	<input type="checkbox"/> 97422
	MARS™ CLIMAPLUS™	54" x 30" x 3/4"	FLB	<input type="checkbox"/> 86831	SLT	<input type="checkbox"/> 88686	SQ	<input type="checkbox"/> 86503
	MARS™ CLIMAPLUS™ High-NRC	54" x 30" x 7/8"	FLB	<input type="checkbox"/> 86501	SLT	<input type="checkbox"/> 86464	SQ	<input type="checkbox"/> 86427

Channel Panels	HALCYON™ CLIMAPLUS™	6" x 60" x 1"	FL	<input type="checkbox"/> 98199	SL	<input type="checkbox"/> 99272	SQ	<input type="checkbox"/> 97228
	MARS™ CLIMAPLUS™	6" x 60" x 3/4"	FLB	<input type="checkbox"/> 86835	SLT	<input type="checkbox"/> 86543	SQ	<input type="checkbox"/> 86507
	MARS™ CLIMAPLUS™ High-NRC	6" x 60" x 7/8"	FLB	<input type="checkbox"/> 86333	SLT	<input type="checkbox"/> 86443	SQ	<input type="checkbox"/> 86145
	PANZ® Metal Panels, Solid	6" x 60"	FL	<input type="checkbox"/> 258036	SL	<input type="checkbox"/> 257972	SQ	<input type="checkbox"/> 257586
	PANZ® Metal Panels, Perf C116	6" x 60"	FL	<input type="checkbox"/> 259228	SL	<input type="checkbox"/> 259010	SQ	<input type="checkbox"/> 259009
	PANZ® Metal Panels, Perf C116D	6" x 60"	FL	<input type="checkbox"/> 259353	SL	<input type="checkbox"/> 259344	SQ	<input type="checkbox"/> 259308

Step 3. Select Corresponding Grid for Selected Panels

			Qty	Item No.	Qty	Item No.	Qty	Item No.
Suspension Systems	CENTRICITEE™ DXT™	Main Tee		<input type="checkbox"/> DXT24				
		Cross Tee 1	2	<input type="checkbox"/> DXT524				
		Cross Tee 2	1	<input type="checkbox"/> DXT524				
	IDENTITEE™ DXI™	Main Tee		<input type="checkbox"/> DXI24				
		Cross Tee 1	2	<input type="checkbox"/> DXI524				
		Cross Tee 2	1	<input type="checkbox"/> DXI524				
	DONN® DX®	Main Tee			<input type="checkbox"/> DX/DXL24		<input type="checkbox"/> DX/DXL24	
		Cross Tee 1			2	<input type="checkbox"/> DX524	2	<input type="checkbox"/> DX524
		Cross Tee 2			1	<input type="checkbox"/> DX524	1	<input type="checkbox"/> DX524

Suspension System Estimator

	Length	Sq. Ft.	Main Tee Usage Per Sq. Ft.	Cross Tee 1 Usage Per Sq. Ft.	Cross Tee 2 Usage Per Sq. Ft.	
System Module	60"	25	0.20	0.40	0.18	

Note: Multiply the ceiling area (SF) by the Usage Factor (UF). This calculation will determine lineal footage of suspension system components required. Please refer to page 11 for stabilizer bar usage.

On-Module Channel Spacing

4' Ceiling Module



6" Channel

System 275

45" x 48" Field Panel

48" x 48" Field Panel

Selector

Channel Width	Ceiling Module	On-Center Channel Spacing	Field Panels	Panel Edge	Suspension System
6"	4' (48")	12' (144")	HALCYON™ CLIMAPLUS™ 45" x 48" x 1" 48" x 48" x 1"	FL 	DXT™, DXI™
				SL 	DX®
				SQ 	DX®

Module Layout

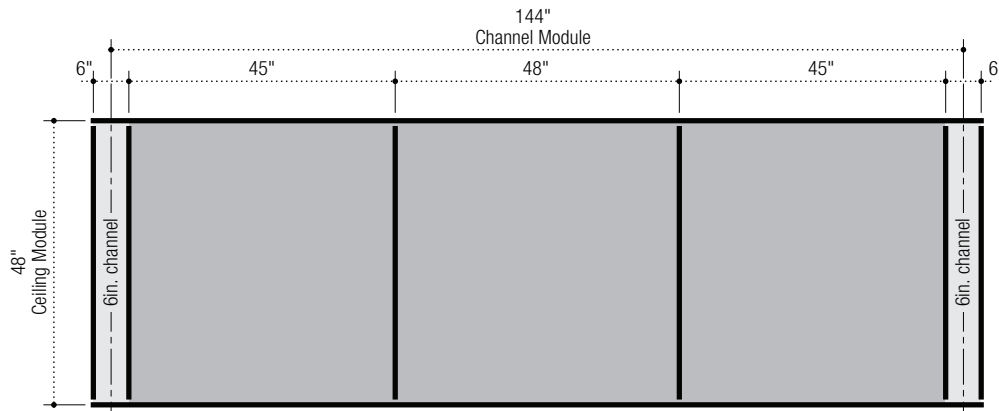

Panel Layout

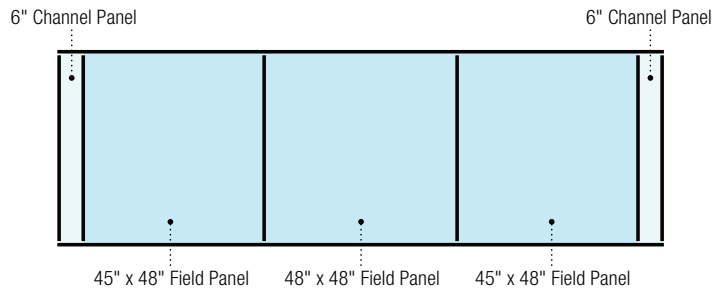

Suspension System Layout

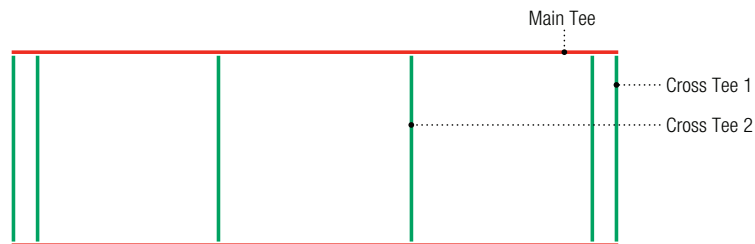

Order Information
System 275

4' Ceiling Module

6" Channel
45" x 48" Field Panel
48" x 48" Field Panel



Step 1. Select Panels

Step 2. Select Edge for Panels

			FL/FLB		SL/SLT		SQ	
			Edge	Item No.	Edge	Item No.	Edge	Item No.
Field Panels	HALCYON™ CLIMAPLUS™	45" x 48" x 1"	FL	<input type="checkbox"/> 97476	SL	<input type="checkbox"/> 97456	SQ	<input type="checkbox"/> 97426

			FL	Item No.	SL	Item No.	SQ	Item No.
Channel Panels	HALCYON™ CLIMAPLUS™	6" x 48" x 1"	FL	<input type="checkbox"/> 98198	SL	<input type="checkbox"/> 99271	SQ	<input type="checkbox"/> 97227
	PANZ® Metal Panels, Solid	6" x 48"	FL	<input type="checkbox"/> 256820	SL	<input type="checkbox"/> 256819	SQ	<input type="checkbox"/> 256768
	PANZ® Metal Panels, Perf C116	6" x 48"	FL	<input type="checkbox"/> 256062	SL	<input type="checkbox"/> 257248	SQ	<input type="checkbox"/> 256397
	PANZ® Metal Panels, Perf C116D	6" x 48"	FL	<input type="checkbox"/> 257585	SL	<input type="checkbox"/> 257584	SQ	<input type="checkbox"/> 257406

Step 3. Select Corresponding Grid for Selected Panels

			Qty	Item No.	Qty	Item No.	Qty	Item No.	
Suspension Systems	CENTRICITEE™ DXT™	Main Tee		<input type="checkbox"/> DXT24SP106					
		Cross Tee 1	2	<input type="checkbox"/> DXT424					
		Cross Tee 2	2	<input type="checkbox"/> DXT424					
	IDENTITEE™ DXI™	Main Tee		<input type="checkbox"/> DXI24SP106					
		Cross Tee 1	2	<input type="checkbox"/> DXI424					
		Cross Tee 2	2	<input type="checkbox"/> DXI424					
	DONN® DX®	Main Tee			<input type="checkbox"/> DX24SP106	1	<input type="checkbox"/> DX24SP106		
		Cross Tee 1			<input type="checkbox"/> DX422	2	<input type="checkbox"/> DX422	2	<input type="checkbox"/> DX422
		Cross Tee 2			<input type="checkbox"/> DX422	2	<input type="checkbox"/> DX422	2	<input type="checkbox"/> DX422

Suspension System Estimator

	Length	Sq. Ft.	Main Tee Usage Per Sq. Ft.	Cross Tee 1 Usage Per Sq. Ft.	Cross Tee 2 Usage Per Sq. Ft.	
System Module	144"	48	0.25	0.17	0.17	

Note: Multiply the ceiling area (SF) by the Usage Factor (UF). This calculation will determine lineal footage of suspension system components required. Please refer to page 11 for stabilizer bar usage.

On-Module Channel Spacing











4' Ceiling Module

12" Channel

System 944

24" x 48" Field Panel

Selector

Channel Width	Ceiling Module	On-Center Channel Spacing	Field Panels	Panel Edge	Suspension System
12"	4' (48")	5' (60")	HALCYON™ CLIMAPLUS™ 24" x 48" x 1"	FL 	DXT™, DXI™
				SL 	DX®
				SQ 	DX®
			MARS™ CLIMAPLUS™ 24" x 48 x 3/4"	FLB 	DXT™, DXI™
				SLT 	DX®
				SQ 	DX®
			MARS™ CLIMAPLUS™ High-NRC 24" x 48" x 7/8"	FLB 	DXT™, DXI™
				SLT 	DX®
				SQ 	DX®
			PANZ® Metal Panels, Solid 24" x 48"	FL 	DXT™, DXI™

Module Layout

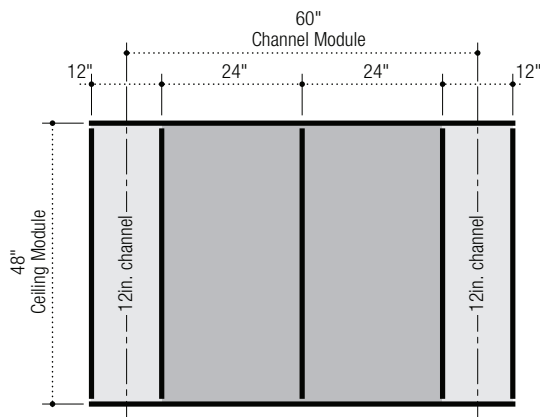

Panel Layout

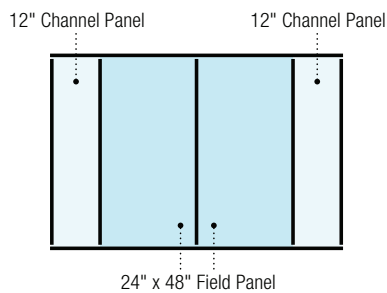

Suspension System Layout

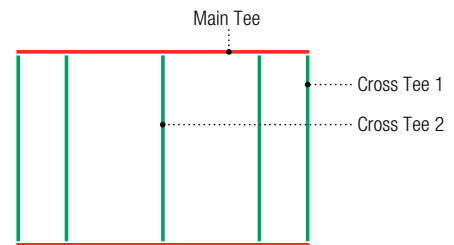

Order Information
System 944

4' Ceiling Module

12" Channel
24" x 48" Field Panel



Step 1. Select Panels

Step 2. Select Edge for Panels

			FL/FLB		SL/SLT		SQ	
			Edge	Item No.	Edge	Item No.	Edge	Item No.
Field Panels	HALCYON™ CLIMAPLUS™	24" x 48" x 1"	FL	<input type="checkbox"/> 98245	SL	<input type="checkbox"/> 98243	SQ	<input type="checkbox"/> 98241
	MARS™ CLIMAPLUS™	24" x 48" x 3/4"	FLB	<input type="checkbox"/> 88985	SLT	<input type="checkbox"/> 88785	SQ	<input type="checkbox"/> 88185
	MARS™ CLIMAPLUS™ High-NRC	24" x 48" x 7/8"	FLB	<input type="checkbox"/> 89500	SLT	<input type="checkbox"/> 89600	SQ	<input type="checkbox"/> 86300
	PANZ® Metal Panels, Solid	24" x 48"	FL	<input type="checkbox"/> 212164				

Channel Panels	HALCYON™ CLIMAPLUS™	12" x 48" x 1"	FL	<input type="checkbox"/> 97575	SL	<input type="checkbox"/> 97571	SQ	<input type="checkbox"/> 97491
	MARS™ CLIMAPLUS™	12" x 48" x 3/4"	FLB	<input type="checkbox"/> 86321	SLT	<input type="checkbox"/> 86544	SQ	<input type="checkbox"/> 86516
	MARS™ CLIMAPLUS™ High-NRC	12" x 48" x 7/8"	FLB	<input type="checkbox"/> 86505	SLT	<input type="checkbox"/> 86444	SQ	<input type="checkbox"/> 86407
	PANZ® Metal Panels, Solid	12" x 48"	FL	<input type="checkbox"/> 212144				

Step 3. Select Corresponding Grid for Selected Panels

			Qty	Item No.	Qty	Item No.	Qty	Item No.
			Suspension Systems	CENTRICITEE™ DXT™	Main Tee		<input type="checkbox"/> DXT24	
Cross Tee 1	2	<input type="checkbox"/> DXT424						
Cross Tee 2	1	<input type="checkbox"/> DXT424						
IDENTITEE™ DXI™	Main Tee			<input type="checkbox"/> DXI24				
	Cross Tee 1	2		<input type="checkbox"/> DXI424				
	Cross Tee 2	1		<input type="checkbox"/> DXI424				
DONN® DX®	Main Tee					<input type="checkbox"/> DX/DXL24		<input type="checkbox"/> DX/DXL24
	Cross Tee 1				2	<input type="checkbox"/> DX422	2	<input type="checkbox"/> DX422
	Cross Tee 2				1	<input type="checkbox"/> DX422	1	<input type="checkbox"/> DX422

Suspension System Estimator

	Length	Sq. Ft.	Main Tee Usage Per Sq. Ft.	Cross Tee 1 Usage Per Sq. Ft.	Cross Tee 2 Usage Per Sq. Ft.	
System Module	60"	20	0.25	0.40	0.20	

Note: Multiply the ceiling area (SF) by the Usage Factor (UF). This calculation will determine lineal footage of suspension system components required. Please refer to page 11 for stabilizer bar usage.

On-Module Channel Spacing











4' Ceiling Module

12" Channel

System 464

24" x 24" Field Panel

Selector

Channel Width	Ceiling Module	On-Center Channel Spacing	Field Panels	Panel Edge	Suspension System
12"	4' (48")	5' (60")	HALCYON™ CLIMAPLUS™ 24" x 24" x 1"	FL 	DXT™, DXI™
				SL 	DX®
				SQ 	DX®, DXT™
			MARS™ CLIMAPLUS™ 24" x 24 x 3/4"	FLB 	DXT™, DXI™
				SLT 	DX®
				SQ 	DX®, DXT™
			MARS™ CLIMAPLUS™ High-NRC 24" x 24" x 7/8"	FLB 	DXT™, DXI™
				SLT 	DX®
				SQ 	DX®, DXT™
			PANZ® Metal Panels, Solid 24" x 24"	FL 	DXT™, DXI™

Module Layout

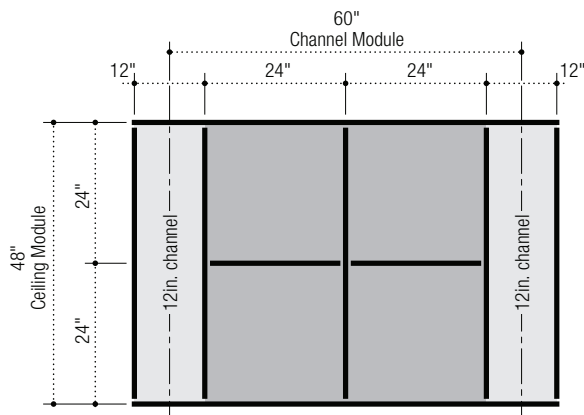

Panel Layout

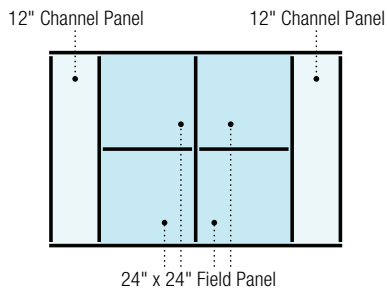

Suspension System Layout

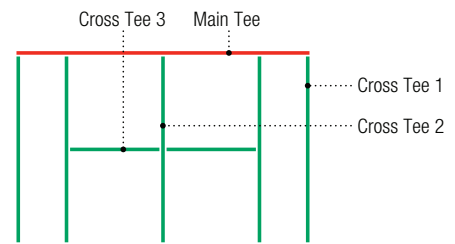

Order Information
System 464

4' Ceiling Module

12" Channel
24" x 24" Field Panel



Step 1. Select Panels

Step 2. Select Edge for Panels

			FL/FLB		SL/SLT		SQ	
			Edge	Item No.	Edge	Item No.	Edge	Item No.
Field Panels	HALCYON™ CLIMAPLUS™	24" x 24" x 1"	FL	<input type="checkbox"/> 98225	SL	<input type="checkbox"/> 98223	SQ	<input type="checkbox"/> 98221
	MARS™ CLIMAPLUS™	24" x 24" x 3/4"	FLB	<input type="checkbox"/> 86985	SLT	<input type="checkbox"/> 86785	SQ	<input type="checkbox"/> 86185
	MARS™ CLIMAPLUS™ High-NRC	24" x 24" x 7/8"	FLB	<input type="checkbox"/> 87100	SLT	<input type="checkbox"/> 87200	SQ	<input type="checkbox"/> 86100
	PANZ® Metal Panels, Solid	24" x 24"	FL	<input type="checkbox"/> 275616				

Channel Panels	HALCYON™ CLIMAPLUS™	12" x 48" x 1"	FL	<input type="checkbox"/> 97575	SL	<input type="checkbox"/> 97571	SQ	<input type="checkbox"/> 97491
	MARS™ CLIMAPLUS™	12" x 48" x 3/4"	FLB	<input type="checkbox"/> 86321	SLT	<input type="checkbox"/> 86544	SQ	<input type="checkbox"/> 86516
	MARS™ CLIMAPLUS™ High-NRC	12" x 48" x 7/8"	FLB	<input type="checkbox"/> 86505	SLT	<input type="checkbox"/> 86444	SQ	<input type="checkbox"/> 86407
	PANZ® Metal Panels, Solid	12" x 48"	FL	<input type="checkbox"/> 212144				

Step 3. Select Corresponding Grid for Selected Panels

			Qty	Item No.	Qty	Item No.	Qty	Item No.
Suspension Systems	CENTRICITEE™ DXT™	Main Tee		<input type="checkbox"/> DXT24				<input type="checkbox"/> DXT24
		Cross Tee 1	2	<input type="checkbox"/> DXT424			2	<input type="checkbox"/> DXT424
		Cross Tee 2	1	<input type="checkbox"/> DXT424			1	<input type="checkbox"/> DXT424
		Cross Tee 3	2	<input type="checkbox"/> DXT222			2	<input type="checkbox"/> DXT222
	IDENTITEE™ DXI™	Main Tee		<input type="checkbox"/> DXI24				
		Cross Tee 1	2	<input type="checkbox"/> DXI424				
		Cross Tee 2	1	<input type="checkbox"/> DXI424				
		Cross Tee 3	2	<input type="checkbox"/> DXI222				
	DONN® DX®	Main Tee				<input type="checkbox"/> DX/DXL24		<input type="checkbox"/> DX/DXL24
		Cross Tee 1			2	<input type="checkbox"/> DX422	2	<input type="checkbox"/> DX422
		Cross Tee 2			1	<input type="checkbox"/> DX422	1	<input type="checkbox"/> DX422
		Cross Tee 3			2	<input type="checkbox"/> DX216	2	<input type="checkbox"/> DX216

Suspension System Estimator

	Length	Sq. Ft.	Main Tee Usage Per Sq. Ft.	Cross Tee 1 Usage Per Sq. Ft.	Cross Tee 2 Usage Per Sq. Ft.	Cross Tee 3 Usage Per Sq. Ft.
System Module	60"	20	0.25	0.40	0.20	0.20

Note: Multiply the ceiling area (SF) by the Usage Factor (UF). This calculation will determine lineal footage of suspension system components required. Please refer to page 11 for stabilizer bar usage.

On-Module Channel Spacing



4' Ceiling Module

12" Channel

System 279

48" x 48" Field Panel

Selector

Channel Width	Ceiling Module	On-Center Channel Spacing	Field Panels	Panel Edge	Suspension System
12"	4' (48")	5' (60")	HALCYON™ CLIMAPLUS™ 48" x 48" x 1"	FL 	DXT™, DXI™
				SL 	DX®
				SQ 	DX®

Module Layout

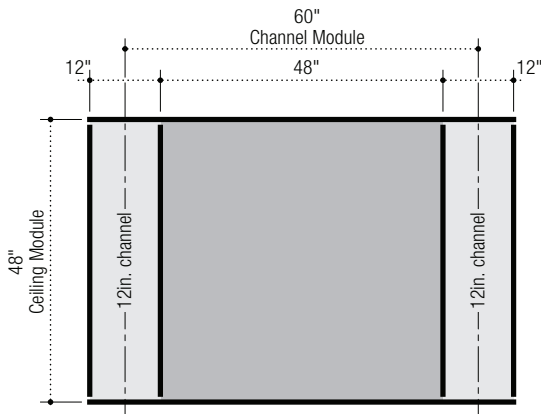

Panel Layout

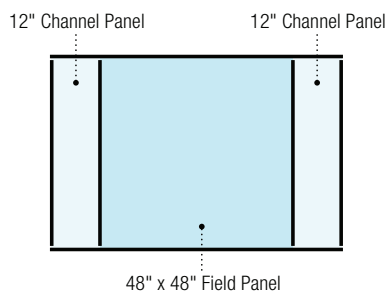

Suspension System Layout

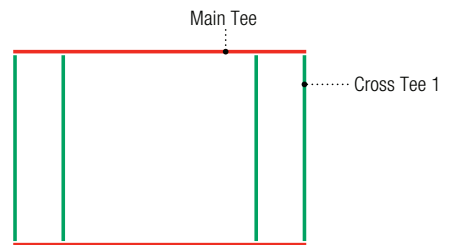

Order Information
System 279

4' Ceiling Module

12" Channel
48" x 48" Field Panel



Step 1. Select Panels

Step 2. Select Edge for Panels

			FL/FLB		SL/SLT		SQ	
			Edge	Item No.	Edge	Item No.	Edge	Item No.
Field Panels	HALCYON™ CLIMAPLUS™	48" x 48" x 1"	FL	<input type="checkbox"/> 98445	SL	<input type="checkbox"/> 98443	SQ	<input type="checkbox"/> 98441

Channel Panels	HALCYON™ CLIMAPLUS™	12" x 48" x 1"	FL	<input type="checkbox"/> 97575	SL	<input type="checkbox"/> 97571	SQ	<input type="checkbox"/> 97491
	PANZ® Metal Panels, Solid	12" x 48"	FL	<input type="checkbox"/> 212144				

Step 3. Select Corresponding Grid for Selected Panels

			Qty	Item No.	Qty	Item No.	Qty	Item No.
Suspension Systems	CENTRICITEE™ DXT™	Main Tee		<input type="checkbox"/> DXT24				
		Cross Tee 1	2	<input type="checkbox"/> DXT424				
	IDENTITEE™ DXI™	Main Tee		<input type="checkbox"/> DXI24				
		Cross Tee 1	2	<input type="checkbox"/> DXI424				
	DONN® DX®	Main Tee			<input type="checkbox"/> DX/DXL24		<input type="checkbox"/> DX/DXL24	
		Cross Tee 1			2	<input type="checkbox"/> DX422	2	<input type="checkbox"/> DX422

Suspension System Estimator

	Length	Sq. Ft.	Main Tee Usage Per Sq. Ft.	Cross Tee 1 Usage Per Sq. Ft.	
System Module	60"	20	0.25	0.40	

Note: Multiply the ceiling area (SF) by the Usage Factor (UF). This calculation will determine lineal footage of suspension system components required. Please refer to page 11 for stabilizer bar usage.

On-Module Channel Spacing











5' Ceiling Module

12" Channel

System 372

30" x 60" Field Panel

Selector

Channel Width	Ceiling Module	On-Center Channel Spacing	Field Panels	Panel Edge	Suspension System
12"	5' (60")	6' (72")	HALCYON™ CLIMAPLUS™ 30" x 60" x 1"	FL 	DXT™, DXI™
				SL 	DX®
				SQ 	DX®
			MARS™ CLIMAPLUS™ 30" x 60" x 3/4"	FLB 	DXT™, DXI™
				SLT 	DX®
				SQ 	DX®
			MARS™ CLIMAPLUS™ High-NRC 30" x 60" x 7/8"	FLB 	DXT™, DXI™
				SLT 	DX®
				SQ 	DX®
			PANZ® Metal Panels, Solid 30" x 60"	FL 	DXT™, DXI™

Module Layout

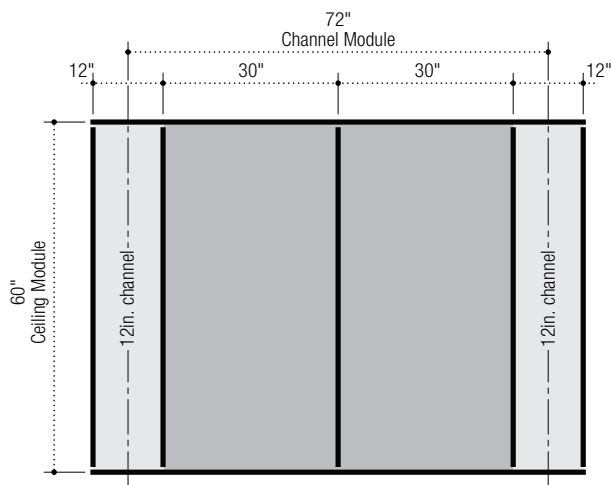

Panel Layout

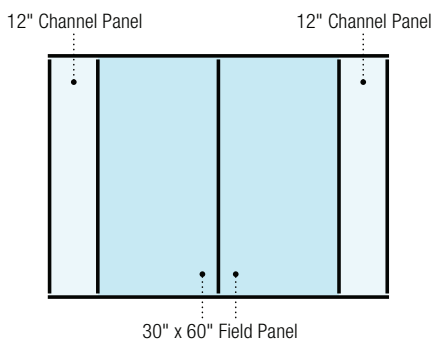

Suspension System Layout

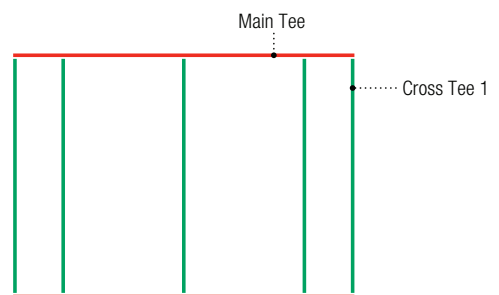

Order Information
System 372

5' Ceiling Module

12" Channel
30" x 60" Field Panel



Step 1. Select Panels

Step 2. Select Edge for Panels

			FL/FLB		SL/SLT		SQ	
			Edge	Item No.	Edge	Item No.	Edge	Item No.
Field Panels	HALCYON™ CLIMAPLUS™	30" x 60" x 1"	FL	<input type="checkbox"/> 98336	SL	<input type="checkbox"/> 99270	SQ	<input type="checkbox"/> 97266
	MARS™ CLIMAPLUS™	30" x 60" x 3/4"	FLB	<input type="checkbox"/> 86267	SLT	<input type="checkbox"/> 86564	SQ	<input type="checkbox"/> 86536
	MARS™ CLIMAPLUS™ High-NRC	30" x 60" x 7/8"	FLB	<input type="checkbox"/> 86497	SLT	<input type="checkbox"/> 86466	SQ	<input type="checkbox"/> 86429
	PANZ® Metal Panels, Solid	30" x 60"	FL	<input type="checkbox"/> 212201				

			FL/FLB		SL/SLT		SQ	
			Edge	Item No.	Edge	Item No.	Edge	Item No.
Channel Panels	HALCYON™ CLIMAPLUS™	12" x 60" x 1"	FL	<input type="checkbox"/> 97576	SL	<input type="checkbox"/> 97434	SQ	<input type="checkbox"/> 97492
	MARS™ CLIMAPLUS™	12" x 60" x 3/4"	FLB	<input type="checkbox"/> 88885	SLT	<input type="checkbox"/> 86545	SQ	<input type="checkbox"/> 86517
	MARS™ CLIMAPLUS™ High-NRC	12" x 60" x 7/8"	FLB	<input type="checkbox"/> 86477	SLT	<input type="checkbox"/> 86445	SQ	<input type="checkbox"/> 86408
	PANZ® Metal Panels, Solid	12" x 60"	FL	<input type="checkbox"/> 212160				

Step 3. Select Corresponding Grid for Selected Panels

			Qty		Qty		Qty	
			Item No.		Item No.		Item No.	
Suspension Systems	CENTRICITEE™ DXT™	Main Tee		<input type="checkbox"/> DXT24				
		Cross Tee 1	2	<input type="checkbox"/> DXT524				
	IDENTITEE™ DXI™	Main Tee		<input type="checkbox"/> DXI24				
		Cross Tee 1	2	<input type="checkbox"/> DXI524				
	DONN® DX®	Main Tee			<input type="checkbox"/> DX/DXL24		<input type="checkbox"/> DX/DXL24	
		Cross Tee 1			2	<input type="checkbox"/> DX524	2	<input type="checkbox"/> DX524

Suspension System Estimator

	Length	Sq. Ft.	Main Tee Usage Per Sq. Ft.	Cross Tee 1 Usage Per Sq. Ft.	Cross Tee 2 Usage Per Sq. Ft.	
System Module	72"	30	0.20	0.33	0.17	

Note: Multiply the ceiling area (SF) by the Usage Factor (UF). This calculation will determine lineal footage of suspension system components required. Please refer to page 11 for stabilizer bar usage.

On-Module Channel Spacing











5' Ceiling Module

12" Channel

System 934

30" x 30" Field Panel

Selector

Channel Width	Ceiling Module	On-Center Channel Spacing	Field Panels	Panel Edge	Suspension System
12"	5' (60")	6' (72")	HALCYON™ CLIMAPLUS™ 30" x 30" x 1"	FL 	DXT™, DXI™
				SL 	DX®
				SQ 	DX®
			MARS™ CLIMAPLUS™ 30" x 30" x 3/4"	FLB 	DXT™, DXI™
				SLT 	DX®
				SQ 	DX®
			MARS™ CLIMAPLUS™ High-NRC 30" x 30" x 7/8"	FLB 	DXT™, DXI™
				SLT 	DX®
				SQ 	DX®
			PANZ® Metal Panels, Solid 30" x 30"	FL 	DXT™, DXI™

Module Layout

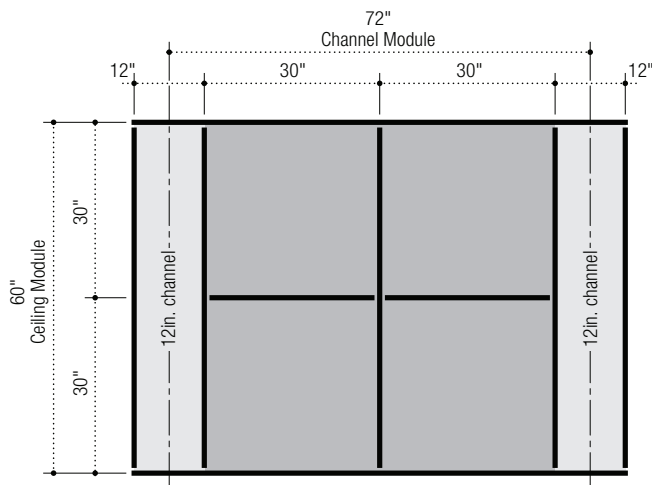

Panel Layout

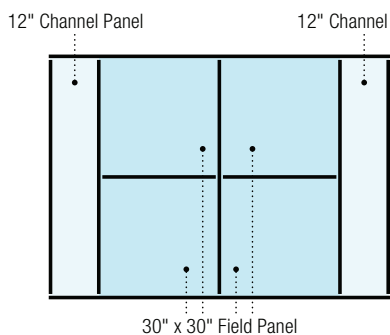

Suspension System Layout

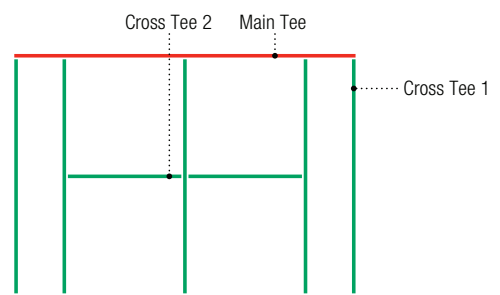

Order Information
System 934

5' Ceiling Module

12" Channel
30" x 30" Field Panel



Step 1. Select Panels

Step 2. Select Edge for Panels

			FL/FLB		SL/SLT		SQ	
			Edge	Item No.	Edge	Item No.	Edge	Item No.
Field Panels	HALCYON™ CLIMAPLUS™	30" x 30" x 1"	FL	<input type="checkbox"/> 98335	SL	<input type="checkbox"/> 98333	SQ	<input type="checkbox"/> 98331
	MARS™ CLIMAPLUS™	30" x 30" x 3/4"	FLB	<input type="checkbox"/> 86830	SLT	<input type="checkbox"/> 86875	SQ	<input type="checkbox"/> 86815
	MARS™ CLIMAPLUS™ High-NRC	30" x 30" x 7/8"	FLB	<input type="checkbox"/> 86400	SLT	<input type="checkbox"/> 86500	SQ	<input type="checkbox"/> 86426
	PANZ® Metal Panels, Solid	30" x 30"	FL	<input type="checkbox"/> 212123				

Channel Panels	HALCYON™ CLIMAPLUS™	12" x 60" x 1"	FL	<input type="checkbox"/> 97576	SL	<input type="checkbox"/> 97434	SQ	<input type="checkbox"/> 97492
	MARS™ CLIMAPLUS™	12" x 60" x 3/4"	FLB	<input type="checkbox"/> 88885	SLT	<input type="checkbox"/> 86545	SQ	<input type="checkbox"/> 86517
	MARS™ CLIMAPLUS™ High-NRC	12" x 60" x 7/8"	FLB	<input type="checkbox"/> 86477	SLT	<input type="checkbox"/> 86445	SQ	<input type="checkbox"/> 86408
	PANZ® Metal Panels, Solid	12" x 60"	FL	<input type="checkbox"/> 212160				

Step 3. Select Corresponding Grid for Selected Panels

			Qty	Item No.	Qty	Item No.	Qty	Item No.
Suspension Systems	CENTRICITEE™ DXT™	Main Tee		<input type="checkbox"/> DXT24				
		Cross Tee 1	2	<input type="checkbox"/> DXT524				
		Cross Tee 2	2	<input type="checkbox"/> DXT3022				
	IDENTITEE™ DXI™	Main Tee		<input type="checkbox"/> DXI24				
		Cross Tee 1	2	<input type="checkbox"/> DXI524				
		Cross Tee 2	2	<input type="checkbox"/> DXI3022				
	DONN® DX®	Main Tee				<input type="checkbox"/> DX/DXL24		<input type="checkbox"/> DX/DXL24
		Cross Tee 1			2	<input type="checkbox"/> DX524	2	<input type="checkbox"/> DX524
		Cross Tee 2			2	<input type="checkbox"/> DX3016	2	<input type="checkbox"/> DX3016

Suspension System Estimator

	Length	Sq. Ft.	Main Tee Usage Per Sq. Ft.	Cross Tee 1 Usage Per Sq. Ft.	Cross Tee 2 Usage Per Sq. Ft.	Cross Tee 3 Usage Per Sq. Ft.
System Module	72"	30	0.20	0.33	0.17	0.17

Note: Multiply the ceiling area (SF) by the Usage Factor (UF). This calculation will determine lineal footage of suspension system components required. Please refer to page 11 for stabilizer bar usage.

On-Module Channel Spacing











5' Ceiling Module

12" Channel

System 649

60" x 20" Field Panel

Selector

Channel Width	Ceiling Module	On-Center Channel Spacing	Field Panels	Panel Edge	Suspension System
12"	5' (60")	6' (72")	HALCYON™ CLIMAPLUS™ 60" x 20" x 1"	FL 	DXT™, DXI™
				SL 	DX®
				SQ 	DX®
			MARS™ CLIMAPLUS™ 60" x 20" x 3/4"	FLB 	DXT™, DXI™
				SLT 	DX®
				SQ 	DX®
			MARS™ CLIMAPLUS™ High-NRC 60" x 20" x 7/8"	FLB 	DXT™, DXI™
				SLT 	DX®
				SQ 	DX®
			PANZ® Metal Panels, Solid 60" x 20"	FL 	DXT™, DXI™

Module Layout

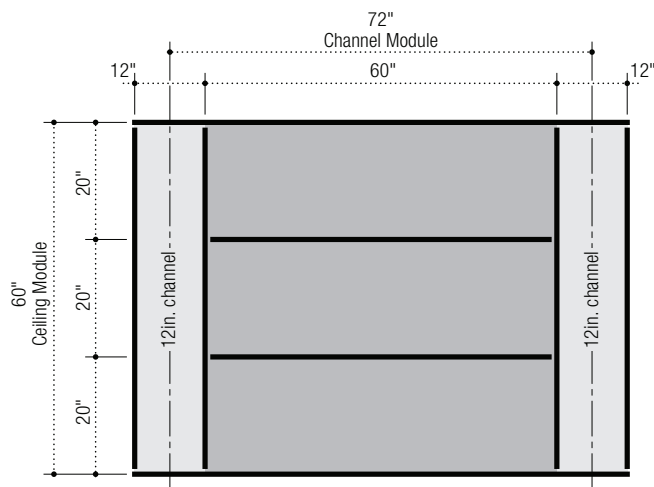

Panel Layout

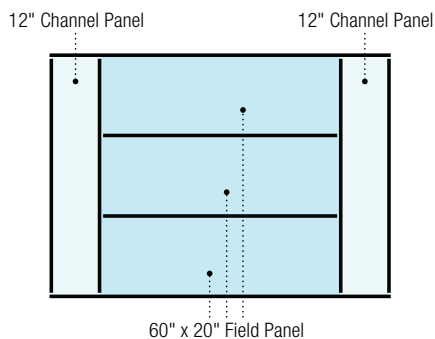

Suspension System Layout

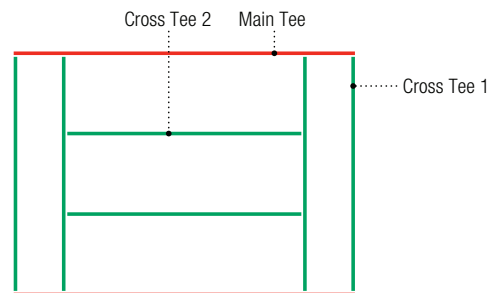

Order Information
System 649

5' Ceiling Module

12" Channel
60" x 20" Field Panel



Step 1. Select Panels

Step 2. Select Edge for Panels

			FL/FLB		SL/SLT		SQ	
			Edge	Item No.	Edge	Item No.	Edge	Item No.
Field Panels	HALCYON™ CLIMAPLUS™	60" x 20" x 1"	FL	<input type="checkbox"/> 98194	SL	<input type="checkbox"/> 99267	SQ	<input type="checkbox"/> 98261
	MARS™ CLIMAPLUS™	60" x 20" x 3/4"	FLB	<input type="checkbox"/> 86164	SLT	<input type="checkbox"/> 86905	SQ	<input type="checkbox"/> 86160
	MARS™ CLIMAPLUS™ High-NRC	60" x 20" x 7/8"	FLB	<input type="checkbox"/> 86481	SLT	<input type="checkbox"/> 86449	SQ	<input type="checkbox"/> 89501
	PANZ® Metal Panels, Solid	60" x 20"	FL	<input type="checkbox"/> 212181				

Channel Panels	HALCYON™ CLIMAPLUS™	12" x 60" x 1"	FL	<input type="checkbox"/> 97576	SL	<input type="checkbox"/> 97434	SQ	<input type="checkbox"/> 97492
	MARS™ CLIMAPLUS™	12" x 60" x 3/4"	FLB	<input type="checkbox"/> 88885	SLT	<input type="checkbox"/> 86545	SQ	<input type="checkbox"/> 86517
	MARS™ CLIMAPLUS™ High-NRC	12" x 60" x 7/8"	FLB	<input type="checkbox"/> 86477	SLT	<input type="checkbox"/> 86445	SQ	<input type="checkbox"/> 86408
	PANZ® Metal Panels, Solid	12" x 60"	FL	<input type="checkbox"/> 212160				

Step 3. Select Corresponding Grid for Selected Panels

			Qty	Item No.	Qty	Item No.	Qty	Item No.
Suspension Systems	CENTRICITEE™ DXT™	Main Tee		<input type="checkbox"/> DXT24				
		Cross Tee 1	2	<input type="checkbox"/> DXT524				
		Cross Tee 2	2	<input type="checkbox"/> DXT524				
	IDENTITEE™ DXI™	Main Tee		<input type="checkbox"/> DXI24				
		Cross Tee 1	2	<input type="checkbox"/> DXI524				
		Cross Tee 2	2	<input type="checkbox"/> DXI524				
	DONN® DX®	Main Tee				<input type="checkbox"/> DX/DXL24		<input type="checkbox"/> DX/DXL24
		Cross Tee 1			2	<input type="checkbox"/> DX524	2	<input type="checkbox"/> DX524
		Cross Tee 2			2	<input type="checkbox"/> DX524	2	<input type="checkbox"/> DX524

Suspension System Estimator

	Length	Sq. Ft.	Main Tee Usage Per Sq. Ft.	Cross Tee 1 Usage Per Sq. Ft.	Cross Tee 2 Usage Per Sq. Ft.	
System Module	72"	30	0.20	0.33	0.33	

Note: Multiply the ceiling area (SF) by the Usage Factor (UF). This calculation will determine lineal footage of suspension system components required. Please refer to page 11 for stabilizer bar usage.

On-Module Channel Spacing











6' Ceiling Module

12" Channel

System 997

24" x 48" Field Panel

Selector

Channel Width	Ceiling Module	On-Center Channel Spacing	Field Panels	Panel Edge	Suspension System
12"	6' (72")	5' (60")	HALCYON™ CLIMAPLUS™ 24" x 48" x 1"	FL 	DXT™, DXI™
				SL 	DX®
				SQ 	DX®
			MARS™ CLIMAPLUS™ 24" x 48 x 3/4"	FLB 	DXT™, DXI™
				SLT 	DX®
				SQ 	DX®
			MARS™ CLIMAPLUS™ High-NRC 24" x 48" x 7/8"	FLB 	DXT™, DXI™
				SLT 	DX®
				SQ 	DX®
			PANZ® Metal Panels, Solid 24" x 48"	FL 	DXT™, DXI™

Module Layout

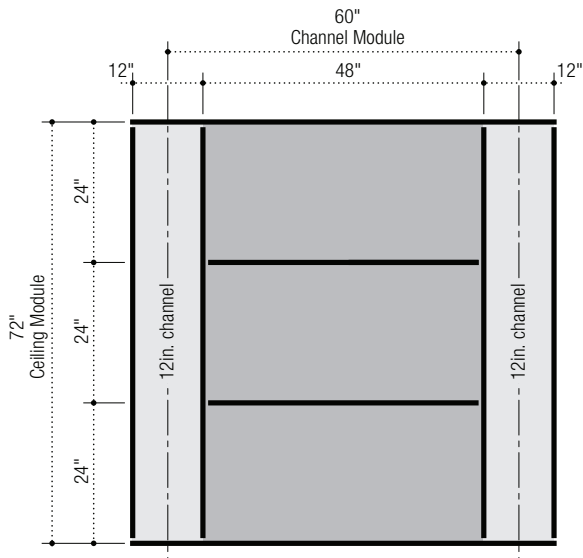

Panel Layout

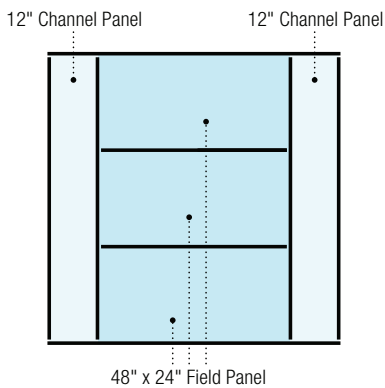

Suspension System Layout

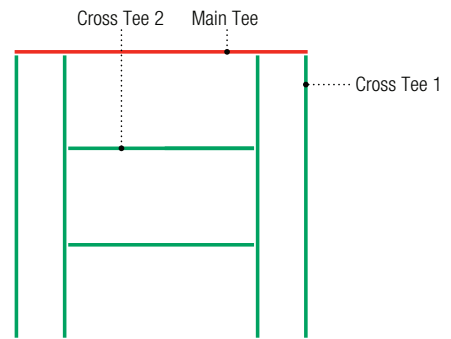

Order Information
System 997

6' Ceiling Module

12" Channel
24" x 48" Field Panel

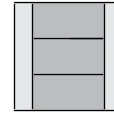

Step 1. Select Panels

Step 2. Select Edge for Panels

			FL/FLB		SL/SLT		SQ	
			Edge	Item No.	Edge	Item No.	Edge	Item No.
Field Panels	HALCYON™ CLIMAPLUS™	24" x 48" x 1"	FL	<input type="checkbox"/> 98245	SL	<input type="checkbox"/> 98243	SQ	<input type="checkbox"/> 98241
	MARS™ CLIMAPLUS™	24" x 48" x 3/4"	FLB	<input type="checkbox"/> 88985	SLT	<input type="checkbox"/> 88785	SQ	<input type="checkbox"/> 88185
	MARS™ CLIMAPLUS™ High-NRC	24" x 48" x 7/8"	FLB	<input type="checkbox"/> 89500	SLT	<input type="checkbox"/> 89600	SQ	<input type="checkbox"/> 86300
	PANZ® Metal Panels, Solid	24" x 48"	FL	<input type="checkbox"/> 212164				

Channel Panels	HALCYON™ CLIMAPLUS™	12" x 72" x 1"	FL	<input type="checkbox"/> 97463	SL	<input type="checkbox"/> 97435	SQ	<input type="checkbox"/> 97406
	MARS™ CLIMAPLUS™	12" x 72" x 3/4"	FLB	<input type="checkbox"/> 86570	SLT	<input type="checkbox"/> 86546	SQ	<input type="checkbox"/> 86518
	MARS™ CLIMAPLUS™ High-NRC	12" x 72" x 7/8"	FLB	<input type="checkbox"/> 86478	SLT	<input type="checkbox"/> 86446	SQ	<input type="checkbox"/> 86409
	PANZ® Metal Panels, Solid	12" x 72"	FL	<input type="checkbox"/> 202654				

Step 3. Select Corresponding Grid for Selected Panels

			Qty	Item No.	Qty	Item No.	Qty	Item No.
Suspension Systems	CENTRICITEE™ DXT™	Main Tee		<input type="checkbox"/> DXT24				
		Cross Tee 1	2	<input type="checkbox"/> DXT624				
		Cross Tee 2	2	<input type="checkbox"/> DXT424				
	IDENTITEE™ DXI™	Main Tee		<input type="checkbox"/> DXI24				
		Cross Tee 1	2	<input type="checkbox"/> DXI624				
		Cross Tee 2	2	<input type="checkbox"/> DXI424				
	DONN® DX®	Main Tee			<input type="checkbox"/> DX/DXL24		<input type="checkbox"/> DX/DXL24	
		Cross Tee 1			2	<input type="checkbox"/> DX624	2	<input type="checkbox"/> DX624
		Cross Tee 2			2	<input type="checkbox"/> DX422	2	<input type="checkbox"/> DX422

Suspension System Estimator

	Length	Sq. Ft.	Main Tee Usage Per Sq. Ft.	Cross Tee 1 Usage Per Sq. Ft.	Cross Tee 2 Usage Per Sq. Ft.	
System Module	60"	30	0.17	0.40	0.27	

Note: Multiply the ceiling area (SF) by the Usage Factor (UF). This calculation will determine lineal footage of suspension system components required. Please refer to page 11 for stabilizer bar usage.

On-Module Channel Spacing











6' Ceiling Module

12" Channel

System 665

24" x 24" Field Panel

Selector

Channel Width	Ceiling Module	On-Center Channel Spacing	Field Panels	Panel Edge	Suspension System
12"	6' (72")	5' (60")	HALCYON™ CLIMAPLUS™ 24" x 24" x 1"	FL 	DXT™, DXI™
				SL 	DX®
				SQ 	DX®, DXT™
			MARS™ CLIMAPLUS™ 24" x 24" x 3/4"	FLB 	DXT™, DXI™
				SLT 	DX®
				SQ 	DX®, DXT™
			MARS™ CLIMAPLUS™ High-NRC 24" x 24" x 7/8"	FLB 	DXT™, DXI™
				SLT 	DX®
				SQ 	DX®, DXT™
			PANZ® Metal Panels, Solid 24" x 24"	FL 	DXT™, DXI™

Module Layout

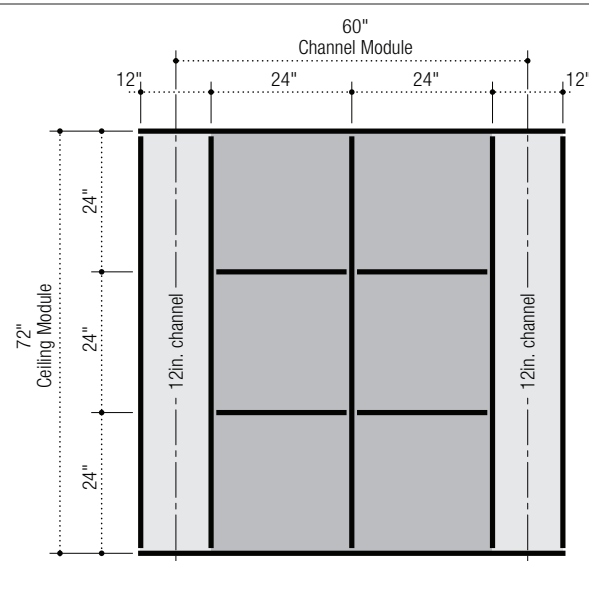

Panel Layout

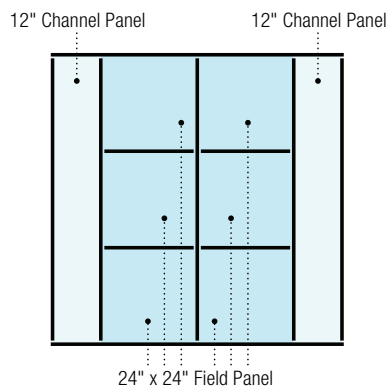

Suspension System Layout

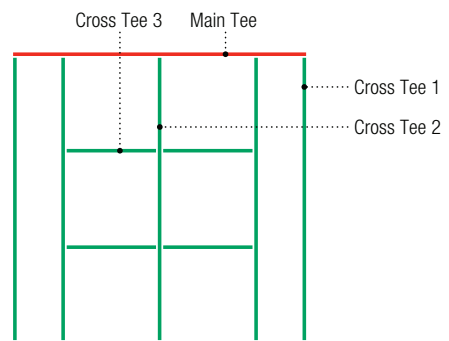

Order Information
System 665

6' Ceiling Module

12" Channel
24" x 24" Field Panel

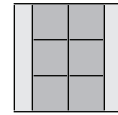

Step 1. Select Panels

Step 2. Select Edge for Panels

			FL/FLB		SL/SLT		SQ	
			Edge	Item No.	Edge	Item No.	Edge	Item No.
Field Panels	HALCYON™ CLIMAPLUS™	24" x 24" x 1"	FL	<input type="checkbox"/> 98225	SL	<input type="checkbox"/> 98223	SQ	<input type="checkbox"/> 98221
	MARS™ CLIMAPLUS™	24" x 24" x 3/4"	FLB	<input type="checkbox"/> 86985	SLT	<input type="checkbox"/> 86785	SQ	<input type="checkbox"/> 86185
	MARS™ CLIMAPLUS™ High-NRC	24" x 24" x 7/8"	FLB	<input type="checkbox"/> 87100	SLT	<input type="checkbox"/> 87200	SQ	<input type="checkbox"/> 86100
	PANZ® Metal Panels, Solid	24" x 24"	FL	<input type="checkbox"/> 275616				

Channel Panels	HALCYON™ CLIMAPLUS™	12" x 72" x 1"	FL	<input type="checkbox"/> 97463	SL	<input type="checkbox"/> 97435	SQ	<input type="checkbox"/> 97406
	MARS™ CLIMAPLUS™	12" x 72" x 3/4"	FLB	<input type="checkbox"/> 86570	SLT	<input type="checkbox"/> 86546	SQ	<input type="checkbox"/> 86518
	MARS™ CLIMAPLUS™ High-NRC	12" x 72" x 7/8"	FLB	<input type="checkbox"/> 86478	SLT	<input type="checkbox"/> 86446	SQ	<input type="checkbox"/> 86409
	PANZ® Metal Panels, Solid	12" x 72"	FL	<input type="checkbox"/> 202654				

Step 3. Select Corresponding Grid for Selected Panels

			Qty	Item No.	Qty	Item No.	Qty	Item No.
			Suspension Systems	CENTRICITEE™ DXT™	Main Tee		<input type="checkbox"/> DXT24	
Cross Tee 1	2	<input type="checkbox"/> DXT624					2	<input type="checkbox"/> DXT624
Cross Tee 2	1	<input type="checkbox"/> DXT624					1	<input type="checkbox"/> DXT624
Cross Tee 3	4	<input type="checkbox"/> DXT222					4	<input type="checkbox"/> DXT222
IDENTITEE™ DXI™	Main Tee			<input type="checkbox"/> DXI24				
	Cross Tee 1	2		<input type="checkbox"/> DXI624				
	Cross Tee 2	1		<input type="checkbox"/> DXI624				
	Cross Tee 3	4		<input type="checkbox"/> DXI222				
DONN® DX®	Main Tee					<input type="checkbox"/> DX/DXL24		<input type="checkbox"/> DX/DXL24
	Cross Tee 1				2	<input type="checkbox"/> DX624	2	<input type="checkbox"/> DX624
	Cross Tee 2				1	<input type="checkbox"/> DX624	1	<input type="checkbox"/> DX624
	Cross Tee 3				4	<input type="checkbox"/> DX216	4	<input type="checkbox"/> DX216

Suspension System Estimator

	Length	Sq. Ft.	Main Tee Usage Per Sq. Ft.	Cross Tee 1 Usage Per Sq. Ft.	Cross Tee 2 Usage Per Sq. Ft.	Cross Tee 3 Usage Per Sq. Ft.
System Module	60"	30	0.17	0.40	0.20	0.27

Note: Multiply the ceiling area (SF) by the Usage Factor (UF). This calculation will determine lineal footage of suspension system components required. Please refer to page 11 for stabilizer bar usage.

On-Module Channel Spacing











6' Ceiling Module

12" Channel

System 785

24" x 72" Field Panel

Selector

Channel Width	Ceiling Module	On-Center Channel Spacing	Field Panels	Panel Edge	Suspension System
12"	6' (72")	5' (60")	HALCYON™ CLIMAPLUS™ 24" x 72" x 1"	FL 	DXT™, DXI™
				SL 	DX®
				SQ 	DX®
			MARS™ CLIMAPLUS™ 24" x 72" x 3/4"	FLB 	DXT™, DXI™
				SLT 	DX®
				SQ 	DX®
			MARS™ CLIMAPLUS™ High-NRC 24" x 72" x 7/8"	FLB 	DXT™, DXI™
				SLT 	DX®
				SQ 	DX®
			PANZ® Metal Panels, Solid 24" x 72"	FL 	DXT™, DXI™

Module Layout

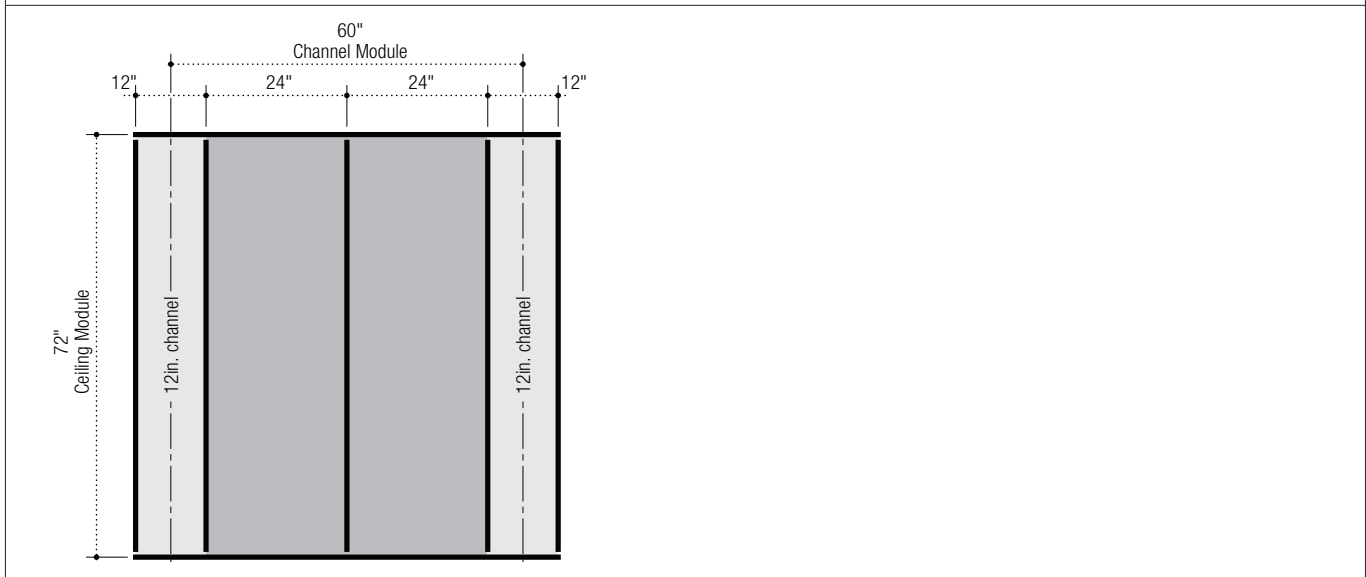

Panel Layout

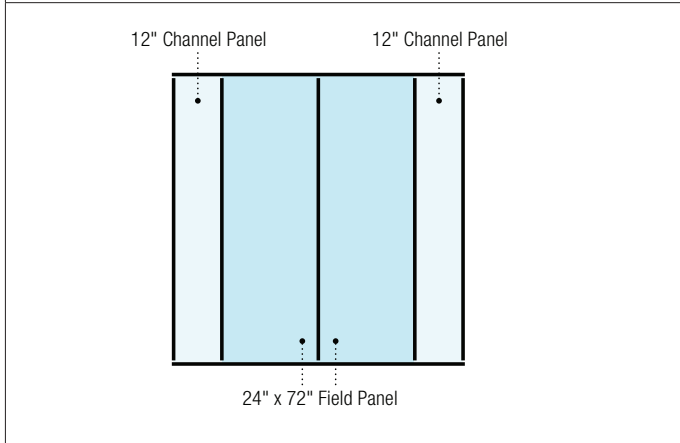

Suspension System Layout

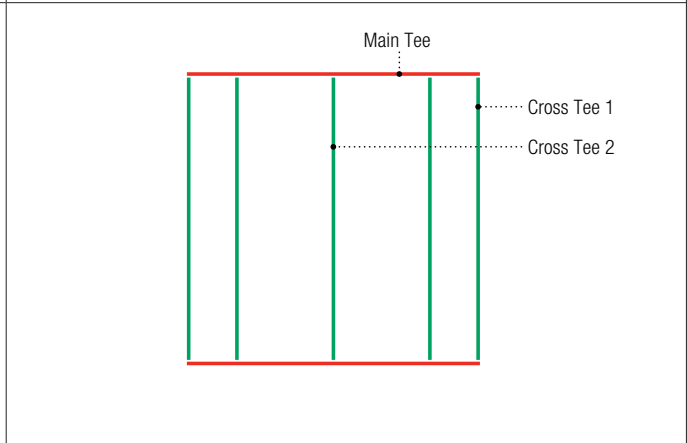

Order Information
System 785

6' Ceiling Module

12" Channel
24" x 72" Field Panel

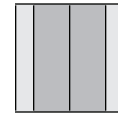

Step 1. Select Panels

Step 2. Select Edge for Panels

			FL/FLB		SL/SLT		SQ	
			Edge	Item No.	Edge	Item No.	Edge	Item No.
Field Panels	HALCYON™ CLIMAPLUS™	24" x 72" x 1"	FL	<input type="checkbox"/> 98348	SL	<input type="checkbox"/> 99268	SQ	<input type="checkbox"/> 99234
	MARS™ CLIMAPLUS™	24" x 72" x 3/4"	FLB	<input type="checkbox"/> 88996	SLT	<input type="checkbox"/> 86166	SQ	<input type="checkbox"/> 86223
	MARS™ CLIMAPLUS™ High-NRC	24" x 72" x 7/8"	FLB	<input type="checkbox"/> 89670	SLT	<input type="checkbox"/> 89660	SQ	<input type="checkbox"/> 86360
	PANZ® Metal Panels, Solid	24" x 72"	FL	<input type="checkbox"/> 212192				

Channel Panels	HALCYON™ CLIMAPLUS™	12" x 72" x 1"	FL	<input type="checkbox"/> 97463	SL	<input type="checkbox"/> 97435	SQ	<input type="checkbox"/> 97406
	MARS™ CLIMAPLUS™	12" x 72" x 3/4"	FLB	<input type="checkbox"/> 86570	SLT	<input type="checkbox"/> 86546	SQ	<input type="checkbox"/> 86518
	MARS™ CLIMAPLUS™ High-NRC	12" x 72" x 7/8"	FLB	<input type="checkbox"/> 86478	SLT	<input type="checkbox"/> 86446	SQ	<input type="checkbox"/> 86409
	PANZ® Metal Panels, Solid	12" x 72"	FL	<input type="checkbox"/> 202654				

Step 3. Select Corresponding Grid for Selected Panels

			Qty	Item No.	Qty	Item No.	Qty	Item No.
Suspension Systems	CENTRICITEE™ DXT™	Main Tee		<input type="checkbox"/> DXT24				
		Cross Tee 1	2	<input type="checkbox"/> DXT624				
		Cross Tee 2	1	<input type="checkbox"/> DXT624				
	IDENTITEE™ DXI™	Main Tee		<input type="checkbox"/> DXI24				
		Cross Tee 1	2	<input type="checkbox"/> DXI624				
		Cross Tee 2	1	<input type="checkbox"/> DXI624				
	DONN® DX®	Main Tee				<input type="checkbox"/> DX/DXL24		<input type="checkbox"/> DX/DXL24
		Cross Tee 1			2	<input type="checkbox"/> DX624	2	<input type="checkbox"/> DX624
		Cross Tee 2			1	<input type="checkbox"/> DX624	1	<input type="checkbox"/> DX624

Suspension System Estimator

	Length	Sq. Ft.	Main Tee Usage Per Sq. Ft.	Cross Tee 1 Usage Per Sq. Ft.	Cross Tee 2 Usage Per Sq. Ft.	
System Module	60"	30	0.17	0.40	0.20	

Note: Multiply the ceiling area (SF) by the Usage Factor (UF). This calculation will determine lineal footage of suspension system components required. Please refer to page 11 for stabilizer bar usage.

Off-Module Channel Spacing











4' Ceiling Module

4" Channel

System 367

24" x 48" Field Panel

Selector

Channel Width	Ceiling Module	On-Center Channel Spacing	Field Panels	Panel Edge	Suspension System
4"	4' (48")	4' - 4" (52")	HALCYON™ CLIMAPLUS™ 24" x 48" x 1"	FL 	DXT™, DXI™
				SL 	DX®
				SQ 	DX®
			MARS™ CLIMAPLUS™ 24" x 48" x 3/4"	FLB 	DXT™, DXI™
				SLT 	DX®
				SQ 	DX®
			MARS™ CLIMAPLUS™ High-NRC 24" x 48" x 7/8"	FLB 	DXT™, DXI™
				SLT 	DX®
				SQ 	DX®
			PANZ® Metal Panels, Solid 24" x 48"	FL 	DXT™, DXI™

Module Layout

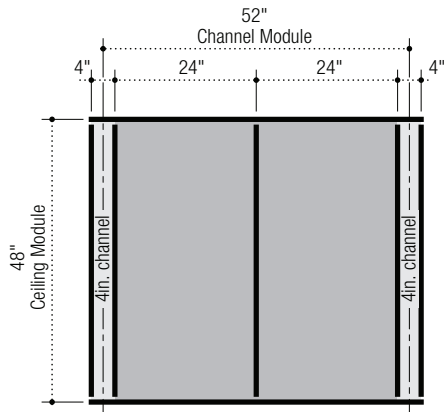

Panel Layout

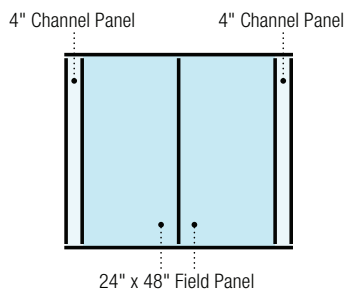

Suspension System Layout

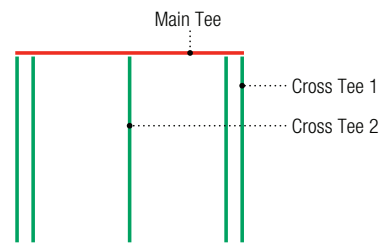

Order Information
System 367

4' Ceiling Module

4" Channel
24" x 48" Field Panel



Step 1. Select Panels

Step 2. Select Edge for Panels

			FL/FLB		SL/SLT		SQ	
			Edge	Item No.	Edge	Item No.	Edge	Item No.
Field Panels	HALCYON™ CLIMAPLUS™	24" x 48" x 1"	FL	<input type="checkbox"/> 98245	SL	<input type="checkbox"/> 98243	SQ	<input type="checkbox"/> 98241
	MARS™ CLIMAPLUS™	24" x 48" x 3/4"	FLB	<input type="checkbox"/> 88985	SLT	<input type="checkbox"/> 88785	SQ	<input type="checkbox"/> 88185
	MARS™ CLIMAPLUS™ High-NRC	24" x 48" x 7/8"	FLB	<input type="checkbox"/> 89500	SLT	<input type="checkbox"/> 89600	SQ	<input type="checkbox"/> 86300
	PANZ® Metal Panels, Solid	24" x 48"	FL	<input type="checkbox"/> 212164				
Channel Panels	MARS™ CLIMAPLUS™	4" x 48" x 3/4"	FLB	<input type="checkbox"/> 86568	SLT	<input type="checkbox"/> 86540	SQ	<input type="checkbox"/> 86514
	MARS™ CLIMAPLUS™ High-NRC	4" x 48" x 7/8"	FLB	<input type="checkbox"/> 86475	SLT	<input type="checkbox"/> 86440	SQ	<input type="checkbox"/> 86402
	PANZ® Metal Panels, Solid	4" x 48"	FL	<input type="checkbox"/> 202636				

Step 3. Select Corresponding Grid for Selected Panels

			Qty	Item No.	Qty	Item No.	Qty	Item No.
Suspension Systems	CENTRICITEE™ DXT™	Main Tee		<input type="checkbox"/> DXT24SP103				
		Cross Tee 1	2	<input type="checkbox"/> DXT424				
		Cross Tee 2	1	<input type="checkbox"/> DXT424				
	IDENTITEE™ DXI™	Main Tee		<input type="checkbox"/> DXI24SP103				
		Cross Tee 1	2	<input type="checkbox"/> DXI424				
		Cross Tee 2	1	<input type="checkbox"/> DXI424				
	DONN® DX®	Main Tee			<input type="checkbox"/> DX24SP103		<input type="checkbox"/> DX24SP103	
		Cross Tee 1			2	<input type="checkbox"/> DX422	2	<input type="checkbox"/> DX422
		Cross Tee 2			1	<input type="checkbox"/> DX422	1	<input type="checkbox"/> DX422

Suspension System Estimator

	Length	Sq. Ft.	Main Tee Usage Per Sq. Ft.	Cross Tee 1 Usage Per Sq. Ft.	Cross Tee 2 Usage Per Sq. Ft.	
System Module	52"	17.333	0.25	0.46	0.23	

Note: Multiply the ceiling area (SF) by the Usage Factor (UF). This calculation will determine lineal footage of suspension system components required. Please refer to page 11 for stabilizer bar usage.

Off-Module Channel Spacing











4' Ceiling Module

6" Channel

System 598

24" x 48" Field Panel

Selector

Channel Width	Ceiling Module	On-Center Channel Spacing	Field Panels	Panel Edge	Suspension System
6"	4' (48")	4' - 6" (54")	HALCYON™ CLIMAPLUS™ 24" x 48" x 1"	FL 	DXT™, DXI™
				SL 	DX®
				SQ 	DX®
			MARS™ CLIMAPLUS™ 24" x 48 x 3/4"	FLB 	DXT™, DXI™
				SLT 	DX®
				SQ 	DX®
			MARS™ CLIMAPLUS™ High-NRC 24" x 48" x 7/8"	FLB 	DXT™, DXI™
				SLT 	DX®
				SQ 	DX®
			PANZ® Metal Panels, Solid 24" x 48"	FL 	DXT™, DXI™

Module Layout

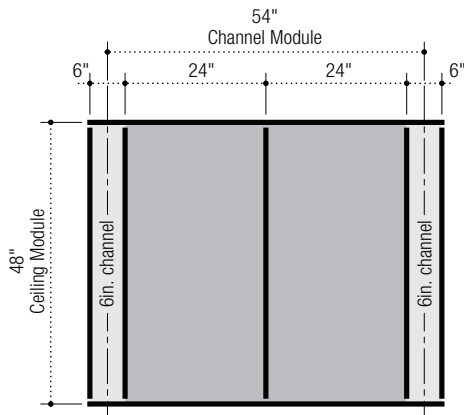

Panel Layout

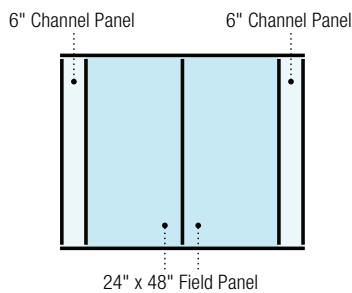

Suspension System Layout

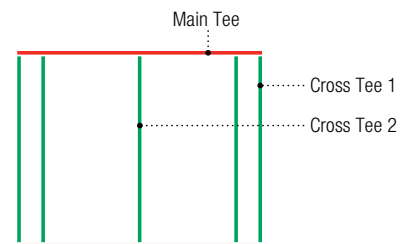

Order Information
System 598

4' Ceiling Module

6" Channel
24" x 48" Field Panel



Step 1. Select Panels

Step 2. Select Edge for Panels

			FL/FLB		SL/SLT		SQ	
			Edge	Item No.	Edge	Item No.	Edge	Item No.
Field Panels	HALCYON™ CLIMAPLUS™	24" x 48" x 1"	FL	<input type="checkbox"/> 98245	SL	<input type="checkbox"/> 98243	SQ	<input type="checkbox"/> 98241
	MARS™ CLIMAPLUS™	24" x 48" x 3/4"	FLB	<input type="checkbox"/> 88985	SLT	<input type="checkbox"/> 88785	SQ	<input type="checkbox"/> 88185
	MARS™ CLIMAPLUS™ High-NRC	24" x 48" x 7/8"	FLB	<input type="checkbox"/> 89500	SLT	<input type="checkbox"/> 89600	SQ	<input type="checkbox"/> 86300
	PANZ® Metal Panels, Solid	24" x 48"	FL	<input type="checkbox"/> 212164				

Channel Panels	HALCYON™ CLIMAPLUS™	6" x 48" x 1"	FL	<input type="checkbox"/> 98198	SL	<input type="checkbox"/> 99271	SQ	<input type="checkbox"/> 97227
	MARS™ CLIMAPLUS™	6" x 48" x 3/4"	FLB	<input type="checkbox"/> 88887	SLT	<input type="checkbox"/> 86542	SQ	<input type="checkbox"/> 86325
	MARS™ CLIMAPLUS™ High-NRC	6" x 48" x 7/8"	FLB	<input type="checkbox"/> 86331	SLT	<input type="checkbox"/> 86442	SQ	<input type="checkbox"/> 86404
	PANZ® Metal Panels, Solid	6" x 48"	FL	<input type="checkbox"/> 256820	SL	<input type="checkbox"/> 256819	SQ	<input type="checkbox"/> 256768
	PANZ® Metal Panels, Perf C116	6" x 48"	FL	<input type="checkbox"/> 256062	SL	<input type="checkbox"/> 257248	SQ	<input type="checkbox"/> 256397
	PANZ® Metal Panels, Perf C116D	6" x 48"	FL	<input type="checkbox"/> 257585	SL	<input type="checkbox"/> 257584	SQ	<input type="checkbox"/> 257406

Step 3. Select Corresponding Grid for Selected Panels

			Qty	Item No.	Qty	Item No.	Qty	Item No.
Suspension Systems	CENTRICITEE™ DXT™	Main Tee		<input type="checkbox"/> DXT24				
		Cross Tee 1	2	<input type="checkbox"/> DXT424				
		Cross Tee 2	1	<input type="checkbox"/> DXT424				
	IDENTITEE™ DXI™	Main Tee		<input type="checkbox"/> DXI24				
		Cross Tee 1	2	<input type="checkbox"/> DXI424				
		Cross Tee 2	1	<input type="checkbox"/> DXI424				
	DONN® DX®	Main Tee				<input type="checkbox"/> DX/DXL24		<input type="checkbox"/> DX/DXL24
		Cross Tee 1			2	<input type="checkbox"/> DX422	2	<input type="checkbox"/> DX422
		Cross Tee 2			1	<input type="checkbox"/> DX422	1	<input type="checkbox"/> DX422

Suspension System Estimator

	Length	Sq. Ft.	Main Tee Usage Per Sq. Ft.	Cross Tee 1 Usage Per Sq. Ft.	Cross Tee 2 Usage Per Sq. Ft.	
System Module	54"	18	0.25	.44	.22	

Note: Multiply the ceiling area (SF) by the Usage Factor (UF). This calculation will determine lineal footage of suspension system components required. Please refer to page 11 for stabilizer bar usage.

Off-Module Channel Spacing











4' Ceiling Module

4" Channel

System 977

24" x 24" Field Panel

Selector

Channel Width	Ceiling Module	On-Center Channel Spacing	Field Panels	Panel Edge	Suspension System
4"	4' (48")	4' - 4" (52")	HALCYON™ CLIMAPLUS™ 24" x 24" x 1"	FL 	DXT™, DXI™
				SL 	DX®
				SQ 	DX®, DXT™
			MARS™ CLIMAPLUS™ 24" x 24" x 3/4"	FLB 	DXT™, DXI™
				SLT 	DX®
				SQ 	DX®, DXT™
			MARS™ CLIMAPLUS™ High-NRC 24" x 24" x 7/8"	FLB 	DXT™, DXI™
				SLT 	DX®
				SQ 	DX®, DXT™
			PANZ® Metal Panels, Solid 24" x 24"	FL 	DXT™, DXI™

Module Layout

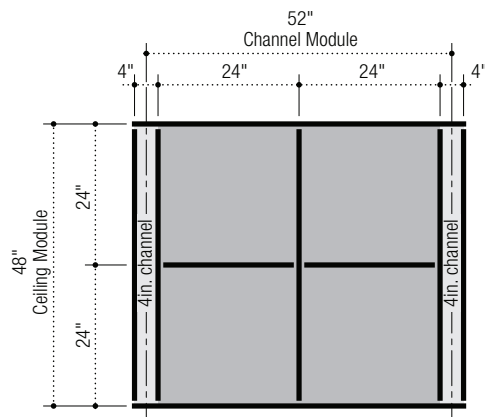

Panel Layout

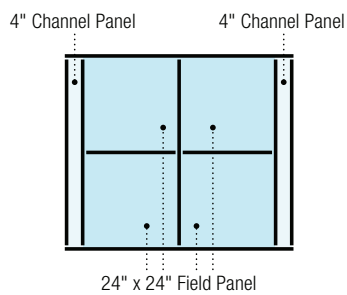

Suspension System Layout

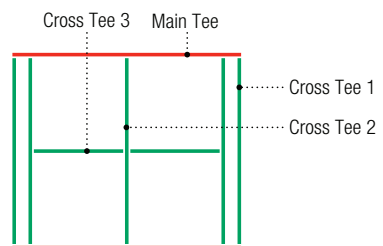

Order Information
System 977

4' Ceiling Module

4" Channel
24" x 24" Field Panel



Step 1. Select Panels

Step 2. Select Edge for Panels

			FL/FLB		SL/SLT		SQ	
			Edge	Item No.	Edge	Item No.	Edge	Item No.
Field Panels	HALCYON™ CLIMAPLUS™	24" x 24" x 1"	FL	<input type="checkbox"/> 98225	SL	<input type="checkbox"/> 98223	SQ	<input type="checkbox"/> 98221
	MARS™ CLIMAPLUS™	24" x 24" x 3/4"	FLB	<input type="checkbox"/> 86985	SLT	<input type="checkbox"/> 86785	SQ	<input type="checkbox"/> 86185
	MARS™ CLIMAPLUS™ High-NRC	24" x 24" x 7/8"	FLB	<input type="checkbox"/> 87100	SLT	<input type="checkbox"/> 87200	SQ	<input type="checkbox"/> 86100
	PANZ® Metal Panels, Solid	24" x 24"	FL	<input type="checkbox"/> 275616				
Channel Panels	MARS™ CLIMAPLUS™	4" x 48" x 3/4"	FLB	<input type="checkbox"/> 86568	SLT	<input type="checkbox"/> 86540	SQ	<input type="checkbox"/> 86514
	MARS™ CLIMAPLUS™ High-NRC	4" x 48" x 7/8"	FLB	<input type="checkbox"/> 86475	SLT	<input type="checkbox"/> 86440	SQ	<input type="checkbox"/> 86402

Step 3. Select Corresponding Grid for Selected Panels

			Qty	Item No.	Qty	Item No.	Qty	Item No.
Suspension Systems	CENTRICITEE™ DXT™	Main Tee		<input type="checkbox"/> DXT24SP103			1	<input type="checkbox"/> DXT24SP103
		Cross Tee 1	2	<input type="checkbox"/> DXT424			2	<input type="checkbox"/> DXT424
		Cross Tee 2	1	<input type="checkbox"/> DXT424			1	<input type="checkbox"/> DXT424
		Cross Tee 3	2	<input type="checkbox"/> DXT222			2	<input type="checkbox"/> DXT222
	IDENTITEE™ DXI™	Main Tee		<input type="checkbox"/> DXI24SP103				
		Cross Tee 1	2	<input type="checkbox"/> DXI424				
		Cross Tee 2	1	<input type="checkbox"/> DXI424				
		Cross Tee 3	2	<input type="checkbox"/> DXI222				
	DONN® DX®	Main Tee			<input type="checkbox"/> DX24SP103		<input type="checkbox"/> DX24SP103	
		Cross Tee 1			2	<input type="checkbox"/> DX422	2	<input type="checkbox"/> DX422
		Cross Tee 2			1	<input type="checkbox"/> DX422	1	<input type="checkbox"/> DX422
		Cross Tee 3			2	<input type="checkbox"/> DX216	2	<input type="checkbox"/> DX216

Suspension System Estimator

	Length	Sq. Ft.	Main Tee Usage Per Sq. Ft.	Cross Tee 1 Usage Per Sq. Ft.	Cross Tee 2 Usage Per Sq. Ft.	Cross Tee 3 Usage Per Sq. Ft.
System Module	54"	18	0.25	0.44	0.22	0.22

Note: Multiply the ceiling area (SF) by the Usage Factor (UF). This calculation will determine lineal footage of suspension system components required. Please refer to page 11 for stabilizer bar usage.

Off-Module Channel Spacing











4' Ceiling Module

6" Channel

System 862

24" x 24" Field Panel

Selector

Channel Width	Ceiling Module	On-Center Channel Spacing	Field Panels	Panel Edge	Suspension System
6"	4' (48")	4' - 6" (54")	HALCYON™ CLIMAPLUS™ 24" x 24" x 1"	FL 	DXT™, DXI™
				SL 	DX®
				SQ 	DX®, DXT™
			MARS™ CLIMAPLUS™ 24" x 24" x 3/4"	FLB 	DXT™, DXI™
				SLT 	DX®
				SQ 	DX®, DXT™
			MARS™ CLIMAPLUS™ High-NRC 24" x 24" x 7/8"	FLB 	DXT™, DXI™
				SLT 	DX®
				SQ 	DX®, DXT™
			PANZ® Metal Panels, Solid 24" x 24"	FL 	DXT™, DXI™

Module Layout

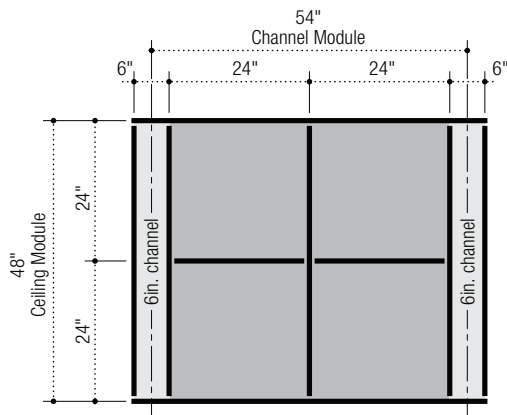

Panel Layout

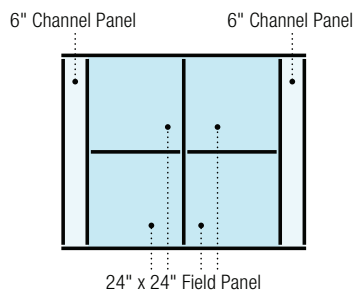

Suspension System Layout

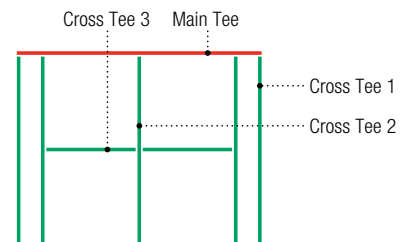

Order Information
System 862

4' Ceiling Module

6" Channel
24" x 24" Field Panel



Step 1. Select Panels

Step 2. Select Edge for Panels

			FL/FLB		SL/SLT		SQ	
			Edge	Item No.	Edge	Item No.	Edge	Item No.
Field Panels	HALCYON™ CLIMAPLUS™	24" x 24" x 1"	FL	<input type="checkbox"/> 98225	SL	<input type="checkbox"/> 98223	SQ	<input type="checkbox"/> 98221
	MARS™ CLIMAPLUS™	24" x 24" x 3/4"	FLB	<input type="checkbox"/> 86985	SLT	<input type="checkbox"/> 86785	SQ	<input type="checkbox"/> 86185
	MARS™ CLIMAPLUS™ High-NRC	24" x 24" x 7/8"	FLB	<input type="checkbox"/> 87100	SLT	<input type="checkbox"/> 87200	SQ	<input type="checkbox"/> 86100
	PANZ® Metal Panels, Solid	24" x 24"	FL	<input type="checkbox"/> 275616				

Channel Panels	HALCYON™ CLIMAPLUS™	6" x 48" x 1"	FL	<input type="checkbox"/> 97572	SL	<input type="checkbox"/> 99271	SQ	<input type="checkbox"/> 97227
	MARS™ CLIMAPLUS™	6" x 48" x 3/4"	FLB	<input type="checkbox"/> 88887	SLT	<input type="checkbox"/> 86542	SQ	<input type="checkbox"/> 86325
	MARS™ CLIMAPLUS™ High-NRC	6" x 48" x 7/8"	FLB	<input type="checkbox"/> 86331	SLT	<input type="checkbox"/> 86442	SQ	<input type="checkbox"/> 86404
	PANZ® Metal Panels, Solid	6" x 48"	FL	<input type="checkbox"/> 256820	SL	<input type="checkbox"/> 256819	SQ	<input type="checkbox"/> 256768
	PANZ® Metal Panels, Perf C116	6" x 48"	FL	<input type="checkbox"/> 256062	SL	<input type="checkbox"/> 257248	SQ	<input type="checkbox"/> 256397
	PANZ® Metal Panels, Perf C116D	6" x 48"	FL	<input type="checkbox"/> 257585	SL	<input type="checkbox"/> 257584	SQ	<input type="checkbox"/> 257406

Step 3. Select Corresponding Grid for Selected Panels

			Qty	Item No.	Qty	Item No.	Qty	Item No.
Suspension Systems	CENTRICITEE™ DXT™	Main Tee		<input type="checkbox"/> DXT24				<input type="checkbox"/> DXT24
		Cross Tee 1	2	<input type="checkbox"/> DXT424			2	<input type="checkbox"/> DXT424
		Cross Tee 2	1	<input type="checkbox"/> DXT424			1	<input type="checkbox"/> DXT424
		Cross Tee 3	2	<input type="checkbox"/> DXT222			2	<input type="checkbox"/> DXT222
	IDENTITEE™ DXI™	Main Tee		<input type="checkbox"/> DXI24				
		Cross Tee 1	2	<input type="checkbox"/> DXI424				
		Cross Tee 2	1	<input type="checkbox"/> DXI424				
		Cross Tee 3	2	<input type="checkbox"/> DXI222				
	DONN® DX®	Main Tee				<input type="checkbox"/> DX/DXL24		<input type="checkbox"/> DX/DXL24
		Cross Tee 1			2	<input type="checkbox"/> DX422	2	<input type="checkbox"/> DX422
		Cross Tee 2			1	<input type="checkbox"/> DX422	1	<input type="checkbox"/> DX422
		Cross Tee 3			2	<input type="checkbox"/> DX216	2	<input type="checkbox"/> DX216

Suspension System Estimator

	Length	Sq. Ft.	Main Tee Usage Per Sq. Ft.	Cross Tee 1 Usage Per Sq. Ft.	Cross Tee 2 Usage Per Sq. Ft.	Cross Tee 3 Usage Per Sq. Ft.
System Module	54"	18	0.25	0.44	0.22	0.22

Note: Multiply the ceiling area (SF) by the Usage Factor (UF). This calculation will determine lineal footage of suspension system components required. Please refer to page 11 for stabilizer bar usage.



Off-Module Channel Spacing

4' Ceiling Module

System 527

4" Channel
48" x 48" Field Panel

Selector

Channel Width	Ceiling Module	On-Center Channel Spacing	Field Panels	Panel Edge	Suspension System
4"	4' (48")	4' - 4" (52")	HALCYON™ CLIMAPLUS™ 48" x 48" x 1"	FL 	DXT™, DXI™
				SL 	DX®
				SQ 	DX®

Module Layout

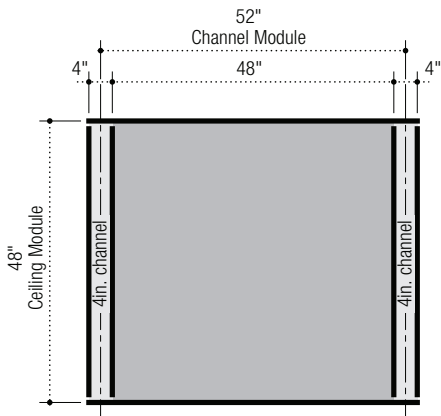

Panel Layout

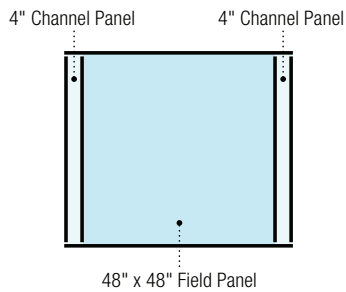

Suspension System Layout

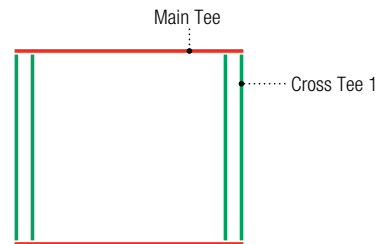

Order Information
System 527

4' Ceiling Module

4" Channel
48" x 48" Field Panel



Step 1. Select Panels

Step 2. Select Edge for Panels

			FL/FLB		SL/SLT		SQ	
			Edge	Item No.	Edge	Item No.	Edge	Item No.
Field Panels	HALCYON™ CLIMAPLUS™	48" x 48" x 1"	FL	<input type="checkbox"/> 98445	SL	<input type="checkbox"/> 98443	SQ	<input type="checkbox"/> 98441

Channel Panels	HALCYON™ CLIMAPLUS™	6" x 48" x 1"	FL	<input type="checkbox"/> 98198	SL	<input type="checkbox"/> 99271	SQ	<input type="checkbox"/> 97227
-----------------------	---------------------	---------------	----	--------------------------------	----	--------------------------------	----	--------------------------------

Step 3. Select Corresponding Grid for Selected Panels

			Qty	Item No.	Qty	Item No.	Qty	Item No.
Suspension Systems	CENTRICITEE™ DXT™	Main Tee		<input type="checkbox"/> DXT24SP103				
		Cross Tee 1	2	<input type="checkbox"/> DXT424				
	IDENTITEE™ DXI™	Main Tee		<input type="checkbox"/> DXI24SP103				
		Cross Tee 1	2	<input type="checkbox"/> DXI424				
	DONN® DX®	Main Tee			<input type="checkbox"/> DX24SP103		<input type="checkbox"/> DX24SP103	
		Cross Tee 1			2	<input type="checkbox"/> DX422	2	<input type="checkbox"/> DX422

Suspension System Estimator

	Length	Sq. Ft.	Main Tee Usage Per Sq. Ft.	Cross Tee 1 Usage Per Sq. Ft.	
System Module	52"	17.333	0.25	0.46	

Note: Multiply the ceiling area (SF) by the Usage Factor (UF). This calculation will determine lineal footage of suspension system components required. Please refer to page 11 for stabilizer bar usage.

Off-Module Channel Spacing



4' Ceiling Module

6" Channel

System 244

48" x 48" Field Panel

Selector

Channel Width	Ceiling Module	On-Center Channel Spacing	Field Panels	Panel Edge	Suspension System
6"	4' (48")	4' - 6" (54")	HALCYON™ CLIMAPLUS™ 48" x 48" x 1"	FL 	DXT™, DXI™
				SL 	DX®
				SQ 	DX®

Module Layout

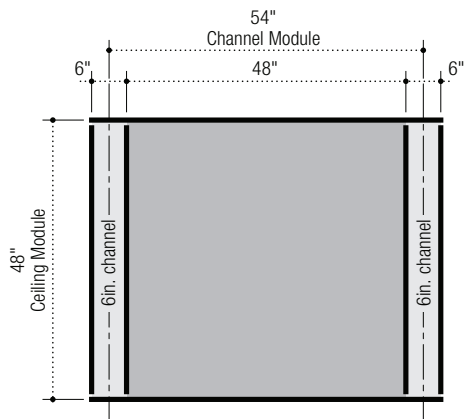

Panel Layout

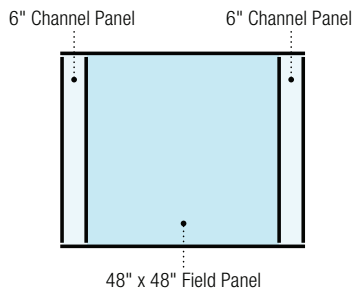

Suspension System Layout

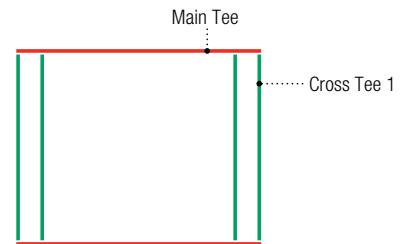

Order Information
System 244

4' Ceiling Module

6" Channel
48" x 48" Field Panel



Step 1. Select Panels

Step 2. Select Edge for Panels

			FL/FLB		SL/SLT		SQ	
			Edge	Item No.	Edge	Item No.	Edge	Item No.
Field Panels	HALCYON™ CLIMAPLUS™	48" x 48" x 1"	FL	<input type="checkbox"/> 98445	SL	<input type="checkbox"/> 98443	SQ	<input type="checkbox"/> 98441

Channel Panels	HALCYON™ CLIMAPLUS™	6" x 48" x 1"	FL	<input type="checkbox"/> 98198	SL	<input type="checkbox"/> 99271	SQ	<input type="checkbox"/> 97227
	PANZ® Metal Panels, Solid	6" x 48"	FL	<input type="checkbox"/> 256820	SL	<input type="checkbox"/> 256819	SQ	<input type="checkbox"/> 256768
	PANZ® Metal Panels, Perf C116	6" x 48"	FL	<input type="checkbox"/> 256062	SL	<input type="checkbox"/> 257248	SQ	<input type="checkbox"/> 256397
	PANZ® Metal Panels, Perf C116D	6" x 48"	FL	<input type="checkbox"/> 257585	SL	<input type="checkbox"/> 257584	SQ	<input type="checkbox"/> 257406

Step 3. Select Corresponding Grid for Selected Panels

			Qty	Item No.	Qty	Item No.	Qty	Item No.
Suspension Systems	CENTRICITEE™ DXT™	Main Tee		<input type="checkbox"/> DXT24				
		Cross Tee 1	2	<input type="checkbox"/> DXT424				
	IDENTITEE™ DXI™	Main Tee		<input type="checkbox"/> DXI24				
		Cross Tee 1	2	<input type="checkbox"/> DXI424				
	DONN® DX®	Main Tee				<input type="checkbox"/> DX/DXL24		<input type="checkbox"/> DX/DXL24
		Cross Tee 1			2	<input type="checkbox"/> DX422	2	<input type="checkbox"/> DX422

Suspension System Estimator

	Length	Sq. Ft.	Main Tee Usage Per Sq. Ft.	Cross Tee 1 Usage Per Sq. Ft.	
System Module	54"	18	0.25	0.44	

Note: Multiply the ceiling area (SF) by the Usage Factor (UF). This calculation will determine lineal footage of suspension system components required. Please refer to page 11 for stabilizer bar usage.





Off-Module Channel Spacing

System 529

4' Ceiling Module

4" Channel
72" x 24" Field Panel

Selector

Channel Width	Ceiling Module	On-Center Channel Spacing	Field Panels	Panel Edge	Suspension System
4"	4' (48")	6' - 4" (76")	HALCYON™ CLIMAPLUS™ 72" x 24" x 1"	FL 	DXT™, DXI™
			MARS™ CLIMAPLUS™ 72" x 24" x 3/4"	FLB 	DXT™, DXI™
			MARS™ CLIMAPLUS™ High-NRC 72" x 24" x 7/8"	FLB 	DXT™, DXI™
			PANZ® Metal Panels, Solid 72" x 24"	FL 	DXT™, DXI™

Module Layout

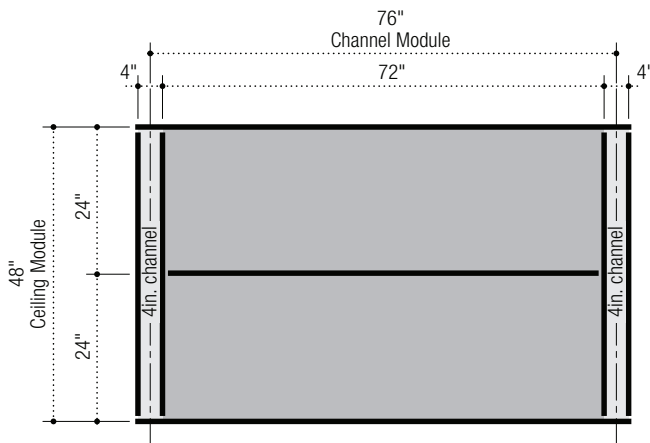

Panel Layout

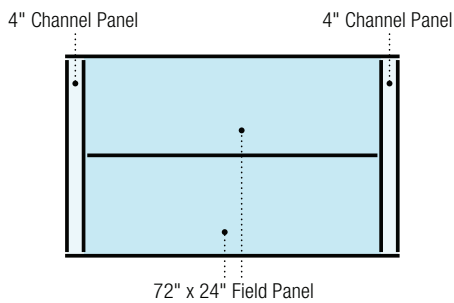

Suspension System Layout

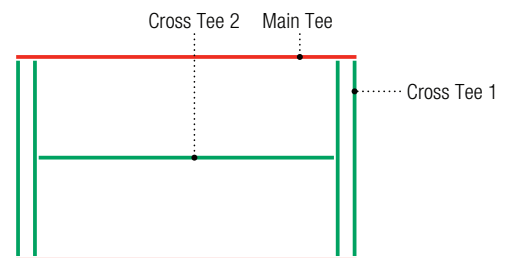

Order Information
System 529

4' Ceiling Module

4" Channel
72" x 24" Field Panel



Step 1. Select Panels

Step 2. Select Edge for Panels

			FL/FLB		SL/SLT		SQ	
			Edge	Item No.	Edge	Item No.	Edge	Item No.
Field Panels	HALCYON™ CLIMAPLUS™	72" x 24" x 1"	FL	<input type="checkbox"/> 98348				
	MARS™ CLIMAPLUS™	72" x 24" x 3/4"	FLB	<input type="checkbox"/> 88996				
	MARS™ CLIMAPLUS™ High-NRC	72" x 24" x 7/8"	FLB	<input type="checkbox"/> 89670				
	PANZ® Metal Panels, Solid	72" x 24"	FL	<input type="checkbox"/> 212192				
Channel Panels	MARS™ CLIMAPLUS™	4" x 48" x 3/4"	FLB	<input type="checkbox"/> 86568				
	MARS™ CLIMAPLUS™ High-NRC	4" x 48" x 7/8"	FLB	<input type="checkbox"/> 86475				
	PANZ® Metal Panels, Solid	4" x 48"	FL	<input type="checkbox"/> 202636				

Step 3. Select Corresponding Grid for Selected Panels

			Qty	Item No.	Qty	Item No.	Qty	Item No.
Suspension Systems	CENTRICITEE™ DXT™	Main Tee		<input type="checkbox"/> DXTSP110				
		Cross Tee 1	2	<input type="checkbox"/> DXT424				
		Cross Tee 2	1	<input type="checkbox"/> DXT624				
	IDENTITEE™ DXI™	Main Tee		<input type="checkbox"/> DXISP110				
		Cross Tee 1	2	<input type="checkbox"/> DXI424				
		Cross Tee 2	1	<input type="checkbox"/> DXI624				

Suspension System Estimator

	Length	Sq. Ft.	Main Tee Usage Per Sq. Ft.	Cross Tee 1 Usage Per Sq. Ft.	Cross Tee 2 Usage Per Sq. Ft.	
System Module	78"	26	0.25	0.31	0.23	











Note: Multiply the ceiling area (SF) by the Usage Factor (UF). This calculation will determine lineal footage of suspension system components required. Please refer to page 11 for stabilizer bar usage.

Off-Module Channel Spacing

4' Ceiling Module

6" Channel
72" x 24" Field Panel

Selector

Channel Width	Ceiling Module	On-Center Channel Spacing	Field Panels	Panel Edge	Suspension System
6"	4' (48")	6' - 6" (78")	HALCYON™ CLIMAPLUS™ 72" x 24" x 1"	FL 	DXT™, DXI™
				SL 	DX®
				SQ 	DX®
			MARS™ CLIMAPLUS™ 72" x 24" x 3/4"	FLB 	DXT™, DXI™
				SLT 	DX®
				SQ 	DX®
			MARS™ CLIMAPLUS™ High-NRC 72" x 24" x 7/8"	FLB 	DXT™, DXI™
				SLT 	DX®
				SQ 	DX®
			PANZ® Metal Panels, Solid 72" x 24"	FL 	DXT™, DXI™

Module Layout

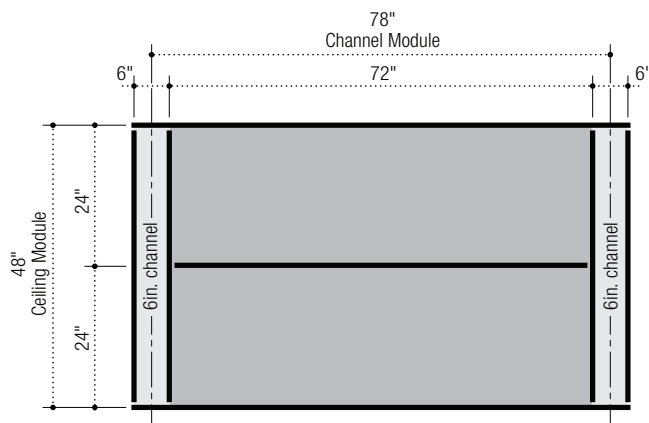

Panel Layout

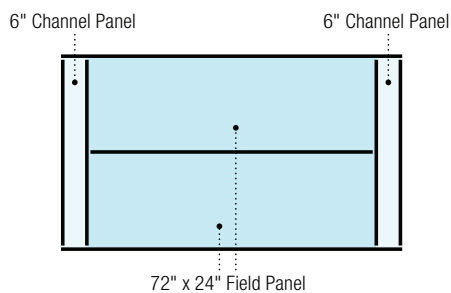

Suspension System Layout

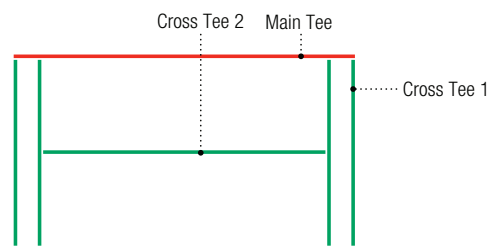

Order Information
System 755

4' Ceiling Module

6" Channel
72" x 24" Field Panel



Step 1. Select Panels

Step 2. Select Edge for Panels

			FL/FLB		SL/SLT		SQ	
			Edge	Item No.	Edge	Item No.	Edge	Item No.
Field Panels	HALCYON™ CLIMAPLUS™	72" x 24" x 1"	FL	<input type="checkbox"/> 98348	SL	<input type="checkbox"/> 99268	SQ	<input type="checkbox"/> 99234
	MARS™ CLIMAPLUS™	72" x 24" x 3/4"	FLB	<input type="checkbox"/> 88996	SLT	<input type="checkbox"/> 86166	SQ	<input type="checkbox"/> 86223
	MARS™ CLIMAPLUS™ High-NRC	72" x 24" x 7/8"	FLB	<input type="checkbox"/> 89670	SLT	<input type="checkbox"/> 89660	SQ	<input type="checkbox"/> 86360
	PANZ® Metal Panels, Solid	72" x 24"	FL	<input type="checkbox"/> 212192				

Channel Panels	HALCYON™ CLIMAPLUS™	6" x 48" x 1"	FL	<input type="checkbox"/> 98198	SL	<input type="checkbox"/> 99271	SQ	<input type="checkbox"/> 97227
	MARS™ CLIMAPLUS™	6" x 48" x 3/4"	FLB	<input type="checkbox"/> 88887	SLT	<input type="checkbox"/> 86542	SQ	<input type="checkbox"/> 86325
	MARS™ CLIMAPLUS™ High-NRC	6" x 48" x 7/8"	FLB	<input type="checkbox"/> 86331	SLT	<input type="checkbox"/> 86442	SQ	<input type="checkbox"/> 86404
	PANZ® Metal Panels, Solid	6" x 48"	FL	<input type="checkbox"/> 256820	SL	<input type="checkbox"/> 256819	SQ	<input type="checkbox"/> 256768
	PANZ® Metal Panels, Perf C116	6" x 48"	FL	<input type="checkbox"/> 256062	SL	<input type="checkbox"/> 257248	SQ	<input type="checkbox"/> 256397
	PANZ® Metal Panels, Perf C116D	6" x 48"	FL	<input type="checkbox"/> 257585	SL	<input type="checkbox"/> 257584	SQ	<input type="checkbox"/> 257406

Step 3. Select Corresponding Grid for Selected Panels

			Qty	Item No.	Qty	Item No.	Qty	Item No.
Suspension Systems	CENTRICITEE™ DXT™	Main Tee		<input type="checkbox"/> DXT24				
		Cross Tee 1	2	<input type="checkbox"/> DXT424				
		Cross Tee 2	1	<input type="checkbox"/> DXT624				
	IDENTITEE™ DXI™	Main Tee		<input type="checkbox"/> DXI24				
		Cross Tee 1	2	<input type="checkbox"/> DXI424				
		Cross Tee 2	1	<input type="checkbox"/> DXI624				
	DONN® DX®	Main Tee				<input type="checkbox"/> DX/DXL24		<input type="checkbox"/> DX/DXL24
		Cross Tee 1			2	<input type="checkbox"/> DX422	2	<input type="checkbox"/> DX422
		Cross Tee 2			1	<input type="checkbox"/> DX624	1	<input type="checkbox"/> DX624

Suspension System Estimator

	Length	Sq. Ft.	Main Tee Usage Per Sq. Ft.	Cross Tee 1 Usage Per Sq. Ft.	Cross Tee 2 Usage Per Sq. Ft.	
System Module	78"	26	0.25	0.31	0.23	











Note: Multiply the ceiling area (SF) by the Usage Factor (UF). This calculation will determine lineal footage of suspension system components required. Please refer to page 11 for stabilizer bar usage.

Off-Module Channel Spacing

4' Ceiling Module

6" Channel
24" x 24" Field Panel

Selector

Channel Width	Ceiling Module	On-Center Channel Spacing	Field Panels	Panel Edge	Suspension System
6"	4' (48")	6' - 6" (78")	HALCYON™ CLIMAPLUS™ 24" x 24" x 1"	FL 	DXT™, DXI™
				SL 	DX®
				SQ 	DX®, DXT™
			MARS™ CLIMAPLUS™ 24" x 24" x 3/4"	FLB 	DXT™, DXI™
				SLT 	DX®
				SQ 	DX®, DXT™
			MARS™ CLIMAPLUS™ High-NRC 24" x 24" x 7/8"	FLB 	DXT™, DXI™
				SLT 	DX®
				SQ 	DX®, DXT™
			PANZ® Metal Panels, Solid 24" x 24"	FL 	DXT™, DXI™

Module Layout

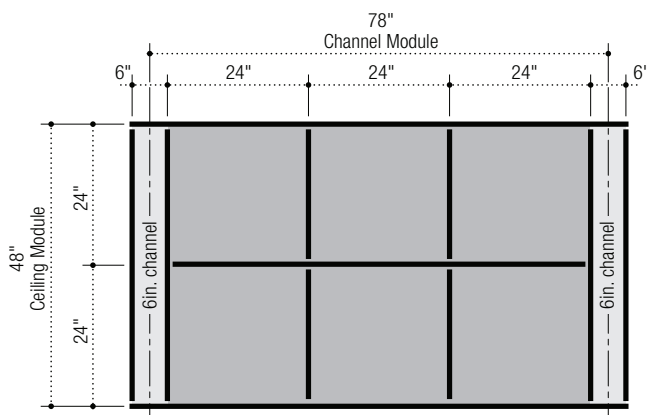

Panel Layout

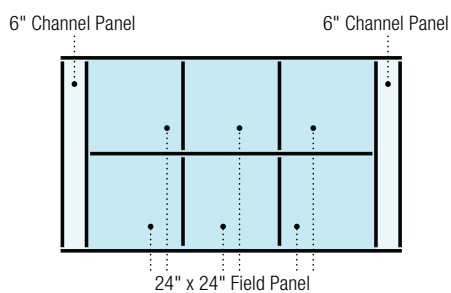

Suspension System Layout

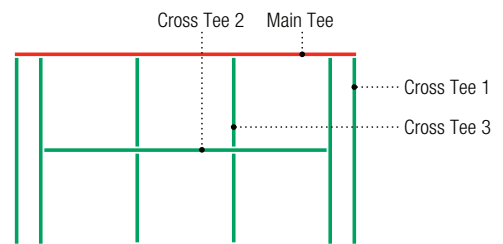

Order Information
System 574

4' Ceiling Module

6" Channel
24" x 24" Field Panel

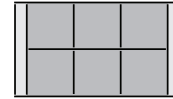

Step 1. Select Panels

Step 2. Select Edge for Panels

			FL/FLB		SL/SLT		SQ	
			Edge	Item No.	Edge	Item No.	Edge	Item No.
Field Panels	HALCYON™ CLIMAPLUS™	24" x 24" x 1"	FL	<input type="checkbox"/> 98225	SL	<input type="checkbox"/> 98223	SQ	<input type="checkbox"/> 98221
	MARS™ CLIMAPLUS™	24" x 24" x 3/4"	FLB	<input type="checkbox"/> 86985	SLT	<input type="checkbox"/> 86785	SQ	<input type="checkbox"/> 86185
	MARS™ CLIMAPLUS™ High-NRC	24" x 24" x 7/8"	FLB	<input type="checkbox"/> 87100	SLT	<input type="checkbox"/> 87200	SQ	<input type="checkbox"/> 86100
	PANZ® Metal Panels, Solid	24" x 24"	FL	<input type="checkbox"/> 275616				

Channel Panels	MARS™ CLIMAPLUS™	4" x 48" x 3/4"	FLB	<input type="checkbox"/> 86568	SLT	<input type="checkbox"/> 86540	SQ	<input type="checkbox"/> 86514
	MARS™ CLIMAPLUS™ High-NRC	4" x 48" x 7/8"	FLB	<input type="checkbox"/> 86475	SLT	<input type="checkbox"/> 86440	SQ	<input type="checkbox"/> 86402
	PANZ® Metal Panels, Solid	4" x 48"	FL	<input type="checkbox"/> 202636				

Step 3. Select Corresponding Grid for Selected Panels

			Qty	Item No.	Qty	Item No.	Qty	Item No.
Suspension Systems	CENTRICITEE™ DXT™	Main Tee		<input type="checkbox"/> DXT24				<input type="checkbox"/> DXT24
		Cross Tee 1	2	<input type="checkbox"/> DXT424			2	<input type="checkbox"/> DXT424
		Cross Tee 2	2	<input type="checkbox"/> DXT424			2	<input type="checkbox"/> DXT424
		Cross Tee 3	3	<input type="checkbox"/> DXT222			3	<input type="checkbox"/> DXT222
	IDENTITEE™ DXI™	Main Tee		<input type="checkbox"/> DXI24				
		Cross Tee 1	2	<input type="checkbox"/> DXI424				
		Cross Tee 2	3	<input type="checkbox"/> DXI424				
		Cross Tee 3	3	<input type="checkbox"/> DXI222				
	DONN® DX®	Main Tee				<input type="checkbox"/> DX/DXL24		<input type="checkbox"/> DX/DXL24
		Cross Tee 1			2	<input type="checkbox"/> DX422	2	<input type="checkbox"/> DX422
		Cross Tee 2			2	<input type="checkbox"/> DX422	2	<input type="checkbox"/> DX422
		Cross Tee 3			3	<input type="checkbox"/> DX216	3	<input type="checkbox"/> DX216

Suspension System Estimator

	Length	Sq. Ft.	Main Tee Usage Per Sq. Ft.	Cross Tee 1 Usage Per Sq. Ft.	Cross Tee 2 Usage Per Sq. Ft.	Cross Tee 3 Usage Per Sq. Ft.
System Module	78"	26	0.25	0.31	0.31	0.23

Note: Multiply the ceiling area (SF) by the Usage Factor (UF). This calculation will determine lineal footage of suspension system components required. Please refer to page 11 for stabilizer bar usage.



Off-Module Channel Spacing

4' Ceiling Module

System 497

4" Channel
42" x 48" Field Panel

Selector

Channel Width	Ceiling Module	On-Center Channel Spacing	Field Panels	Panel Edge	Suspension System
6"	4' (48")	7'-6" (80")	HALCYON™ CLIMAPLUS™ 42" x 48" x 1"	FL 	DXT™, DXI™
				SL 	DX®
				SQ 	DX®

Module Layout

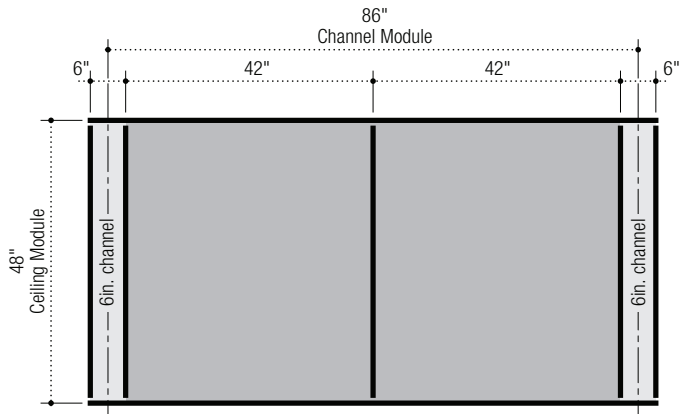

Panel Layout

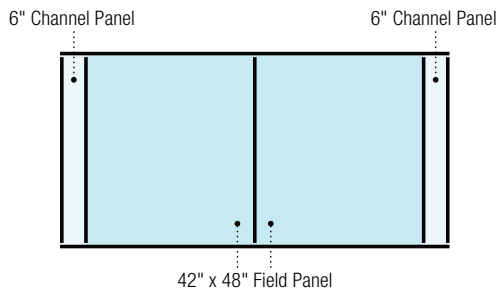

Suspension System Layout

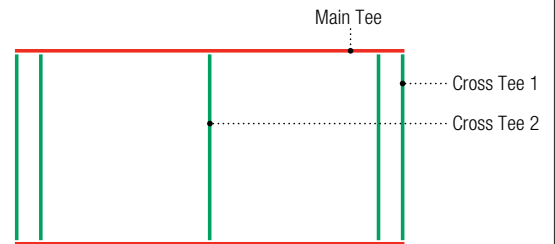

Order Information
System 497

4' Ceiling Module

4" Channel
42" x 48" Field Panel



Step 1. Select Panels

Step 2. Select Edge for Panels

			FL/FLB		SL/SLT		SQ	
			Edge	Item No.	Edge	Item No.	Edge	Item No.
Field Panels	HALCYON™ CLIMAPLUS™	42" x 48" x 1"	FL	<input type="checkbox"/> 98343	SL	<input type="checkbox"/> 97454	SQ	<input type="checkbox"/> 97424

Channel Panels	HALCYON™ CLIMAPLUS™	6" x 48" x 1"	FL	<input type="checkbox"/> 98198	SL	<input type="checkbox"/> 99271	SQ	<input type="checkbox"/> 97227
	PANZ® Metal Panels, Solid	6" x 48"	FL	<input type="checkbox"/> 256820	SL	<input type="checkbox"/> 256819	SQ	<input type="checkbox"/> 256768
	PANZ® Metal Panels, Perf C116	6" x 48"	FL	<input type="checkbox"/> 256062	SL	<input type="checkbox"/> 257248	SQ	<input type="checkbox"/> 256397
	PANZ® Metal Panels, Perf C116D	6" x 48"	FL	<input type="checkbox"/> 257585	SL	<input type="checkbox"/> 257584	SQ	<input type="checkbox"/> 257406

Step 3. Select Corresponding Grid for Selected Panels

			Qty	Item No.	Qty	Item No.	Qty	Item No.
Suspension Systems	CENTRICITEE™ DXT™	Main Tee		<input type="checkbox"/> DXT24				
		Cross Tee 1	2	<input type="checkbox"/> DXT424				
		Cross Tee 2	1	<input type="checkbox"/> DXT424				
	IDENTITEE™ DXI™	Main Tee		<input type="checkbox"/> DXI24				
		Cross Tee 1	2	<input type="checkbox"/> DXI424				
		Cross Tee 2	1	<input type="checkbox"/> DXI424				
	DONN® DX®	Main Tee				<input type="checkbox"/> DX/DXL24		<input type="checkbox"/> DX/DXL24
		Cross Tee 1			2	<input type="checkbox"/> DX422	2	<input type="checkbox"/> DX422
		Cross Tee 2			1	<input type="checkbox"/> DX422	1	<input type="checkbox"/> DX422

Suspension System Estimator

	Length	Sq. Ft.	Main Tee Usage Per Sq. Ft.	Cross Tee 1 Usage Per Sq. Ft.	Cross Tee 2 Usage Per Sq. Ft.	
System Module	90"	30	0.25	0.27	0.13	



Note: Multiply the ceiling area (SF) by the Usage Factor (UF). This calculation will determine lineal footage of suspension system components required. Please refer to page 11 for stabilizer bar usage.

Off-Module Channel Spacing

4' Ceiling Module

4" Channel
96" x 24" Field Panel

Selector

Channel Width	Ceiling Module	On-Center Channel Spacing	Field Panels	Panel Edge	Suspension System
4"	4' (48")	8' - 4" (100")	HALCYON™ CLIMAPLUS™ 96" x 24" x 1"	FL  SL  SQ 	DXT™, DXI™ DX® DX®

Module Layout

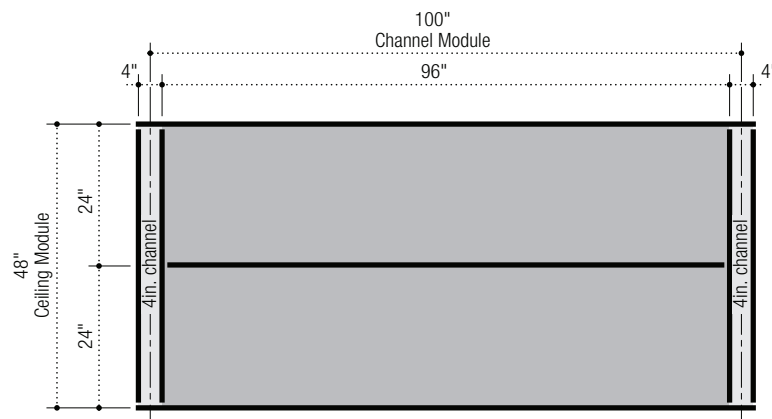

Panel Layout

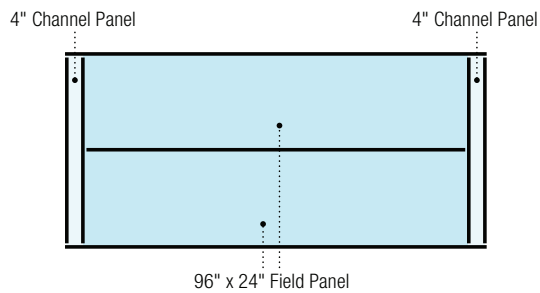

Suspension System Layout

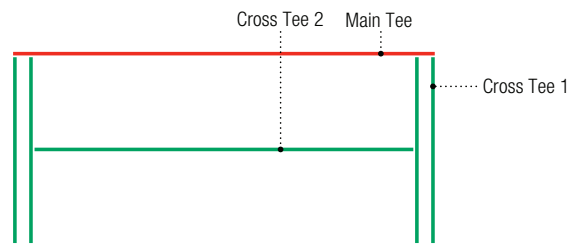

Order Information
System 722

4' Ceiling Module

4" Channel
96" x 24" Field Panel



Step 1. Select Panels

Step 2. Select Edge for Panels

			FL/FLB		SL/SLT		SQ	
			Edge	Item No.	Edge	Item No.	Edge	Item No.
Field Panels	HALCYON™ CLIMAPLUS™	96" x 24" x 1"	FL	<input type="checkbox"/> 98197	SL	<input type="checkbox"/> 99269	SQ	<input type="checkbox"/> 98351

Step 3. Select Corresponding Grid for Selected Panels

			Qty	Item No.	Qty	Item No.	Qty	Item No.
Suspension Systems	CENTRICITEE™ DXT™	Main Tee		<input type="checkbox"/> DXT24SP108				
		Cross Tee 1	2	<input type="checkbox"/> DXT424				
		Cross Tee 2	1	<input type="checkbox"/> DXT824				
	IDENTITEE™ DXI™	Main Tee		<input type="checkbox"/> DXI24SP108				
		Cross Tee 1	2	<input type="checkbox"/> DXI424				
		Cross Tee 2	1	<input type="checkbox"/> DXI824				
	DONN® DX®	Main Tee			<input type="checkbox"/> DX24SP108		<input type="checkbox"/> DX24SP108	
		Cross Tee 1			2	<input type="checkbox"/> DX422	2	<input type="checkbox"/> DX422
		Cross Tee 2			1	<input type="checkbox"/> DX824	1	<input type="checkbox"/> DX824

Suspension System Estimator

	Length	Sq. Ft.	Main Tee Usage Per Sq. Ft.	Cross Tee 1 Usage Per Sq. Ft.	Cross Tee 2 Usage Per Sq. Ft.	
System Module	100"	33.333	0.25	0.24	0.24	

Note: Multiply the ceiling area (SF) by the Usage Factor (UF). This calculation will determine lineal footage of suspension system components required. Please refer to page 11 for stabilizer bar usage.

Off-Module Channel Spacing









4' Ceiling Module

6" Channel

System 754

48" x 48" Field Panel

Selector

Channel Width	Ceiling Module	On-Center Channel Spacing	Field Panels	Panel Edge	Suspension System
6"	4' (48")	8' - 6" (102")	HALCYON™ CLIMAPLUS™ 48" x 48" x 1"	FL 	DXT™, DXI™
				SL 	DX®
				SQ 	DX®
			MARS™ CLIMAPLUS™ 48" x 48 x 3/4"	FLB 	DXT™, DXI™
				SLT 	DX®
				SQ 	DX®
			MARS™ CLIMAPLUS™ High-NRC 48" x 48" x 7/8"	FLB 	DXT™, DXI™
				SLT 	DX®
				SQ 	DX®

Module Layout

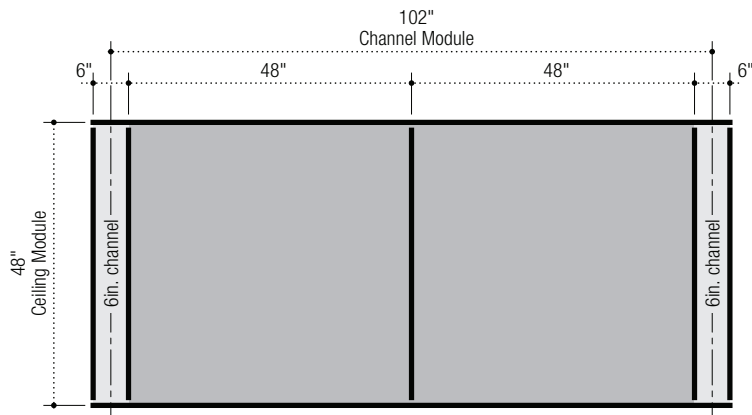

Panel Layout

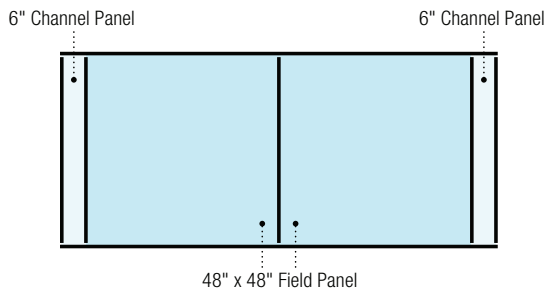

Suspension System Layout

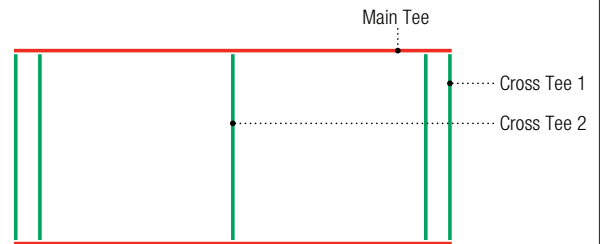

Order Information
System 754

4' Ceiling Module

6" Channel
48" x 48" Field Panel



Step 1. Select Panels

Step 2. Select Edge for Panels

			FL/FLB		SL/SLT		SQ	
			Edge	Item No.	Edge	Item No.	Edge	Item No.
Field Panels	HALCYON™ CLIMAPLUS™	48" x 48" x 1"	FL	<input type="checkbox"/> 98445	SL	<input type="checkbox"/> 98443	SQ	<input type="checkbox"/> 98441
Channel Panels	HALCYON™ CLIMAPLUS™	6" x 48" x 1"	FL	<input type="checkbox"/> 98198	SL	<input type="checkbox"/> 99271	SQ	<input type="checkbox"/> 97227
	PANZ® Metal Panels, Solid	6" x 48"	FL	<input type="checkbox"/> 256820	SL	<input type="checkbox"/> 256819	SQ	<input type="checkbox"/> 256768
	PANZ® Metal Panels, Perf C116	6" x 48"	FL	<input type="checkbox"/> 256062	SL	<input type="checkbox"/> 257248	SQ	<input type="checkbox"/> 256397
	PANZ® Metal Panels, Perf C116D	6" x 48"	FL	<input type="checkbox"/> 257585	SL	<input type="checkbox"/> 257584	SQ	<input type="checkbox"/> 257406

Step 3. Select Corresponding Grid for Selected Panels

			Qty	Item No.	Qty	Item No.	Qty	Item No.
Suspension Systems	CENTRICITEE™ DXT™	Main Tee		<input type="checkbox"/> DXT24				
		Cross Tee 1	2	<input type="checkbox"/> DXT424				
		Cross Tee 2	1	<input type="checkbox"/> DXT424				
	IDENTITEE™ DXI™	Main Tee		<input type="checkbox"/> DXI24				
		Cross Tee 1	2	<input type="checkbox"/> DXI424				
		Cross Tee 2	1	<input type="checkbox"/> DXI424				
	DONN® DX®	Main Tee				<input type="checkbox"/> DX/DXL24		<input type="checkbox"/> DX/DXL24
		Cross Tee 1			2	<input type="checkbox"/> DX422	2	<input type="checkbox"/> DX422
		Cross Tee 2			1	<input type="checkbox"/> DX422	1	<input type="checkbox"/> DX422

Suspension System Estimator

	Length	Sq. Ft.	Main Tee Usage Per Sq. Ft.	Cross Tee 1 Usage Per Sq. Ft.	Cross Tee 2 Usage Per Sq. Ft.	
System Module	102"	34	0.25	0.24	0.12	



Note: Multiply the ceiling area (SF) by the Usage Factor (UF). This calculation will determine lineal footage of suspension system components required. Please refer to page 11 for stabilizer bar usage.

Off-Module Channel Spacing

4' Ceiling Module

6" Channel
96" x 24" Field Panel

Selector

Channel Width	Ceiling Module	On-Center Channel Spacing	Field Panels	Panel Edge	Suspension System
6"	4' (48")	8' - 6" (102")	HALCYON™ CLIMAPLUS™ 96" x 24" x 1"	FL 	DXT™, DXI™
				SL 	DX®
				SQ 	DX®

Module Layout

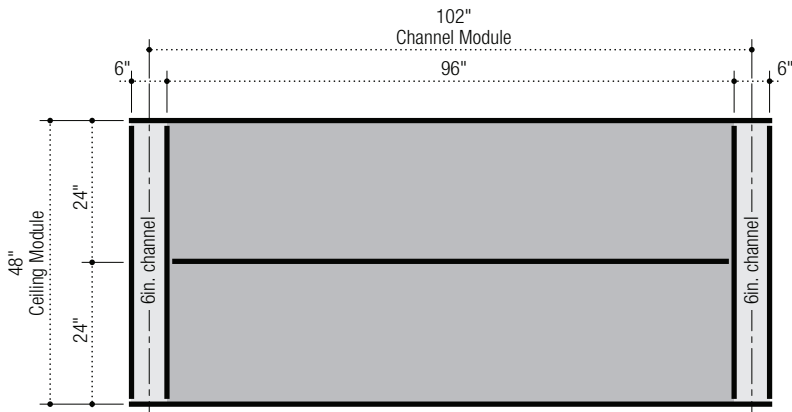

Panel Layout

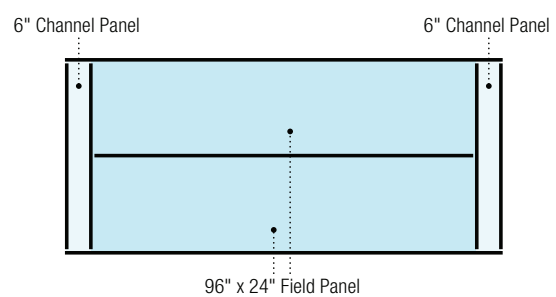

Suspension System Layout

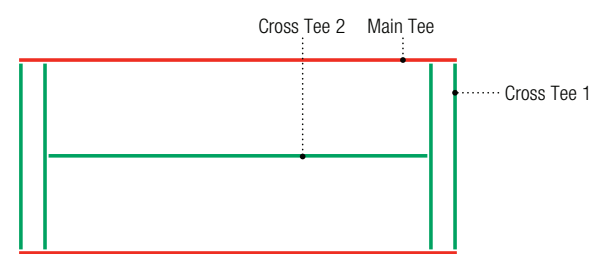

Order Information
System 664

4' Ceiling Module

6" Channel
96" x 24" Field Panel



Step 1. Select Panels

Step 2. Select Edge for Panels

			FL/FLB		SL/SLT		SQ	
			Edge	Item No.	Edge	Item No.	Edge	Item No.
Field Panels	HALCYON™ CLIMAPLUS™	96" x 24" x 1"	FL	<input type="checkbox"/> 98197	SL	<input type="checkbox"/> 99269	SQ	<input type="checkbox"/> 98351

Channel Panels	HALCYON™ CLIMAPLUS™	6" x 48" x 1"	FL	<input type="checkbox"/> 98198	SL	<input type="checkbox"/> 99271	SQ	<input type="checkbox"/> 97227
	PANZ® Metal Panels, Solid	6" x 48"	FL	<input type="checkbox"/> 256820	SL	<input type="checkbox"/> 256819	SQ	<input type="checkbox"/> 256768
	PANZ® Metal Panels, Perf C116	6" x 48"	FL	<input type="checkbox"/> 256062	SL	<input type="checkbox"/> 257248	SQ	<input type="checkbox"/> 256397
	PANZ® Metal Panels, Perf C116D	6" x 48"	FL	<input type="checkbox"/> 257585	SL	<input type="checkbox"/> 257584	SQ	<input type="checkbox"/> 257406

Step 3. Select Corresponding Grid for Selected Panels

			Qty	Item No.	Qty	Item No.	Qty	Item No.
Suspension Systems	CENTRICITEE™ DXT™	Main Tee		<input type="checkbox"/> DXT24				
		Cross Tee 1	2	<input type="checkbox"/> DXT424				
		Cross Tee 2	1	<input type="checkbox"/> DXT824				
	IDENTITEE™ DXI™	Main Tee		<input type="checkbox"/> DXI24				
		Cross Tee 1	2	<input type="checkbox"/> DXI424				
		Cross Tee 2	1	<input type="checkbox"/> DXI824				
	DONN® DX®	Main Tee				<input type="checkbox"/> DX/DXL24		<input type="checkbox"/> DX/DXL24
		Cross Tee 1			2	<input type="checkbox"/> DX422	2	<input type="checkbox"/> DX422
		Cross Tee 2			1	<input type="checkbox"/> DX824	1	<input type="checkbox"/> DX824

Suspension System Estimator

	Length	Sq. Ft.	Main Tee Usage Per Sq. Ft.	Cross Tee 1 Usage Per Sq. Ft.	Cross Tee 2 Usage Per Sq. Ft.	
System Module	102"	34	0.25	0.24	0.12	

Note: Multiply the ceiling area (SF) by the Usage Factor (UF). This calculation will determine lineal footage of suspension system components required. Please refer to page 11 for stabilizer bar usage.



Off-Module Channel Spacing

4' Ceiling Module

System 979

6" Channel
96" x 48" Field Panel

Selector

Channel Width	Ceiling Module	On-Center Channel Spacing	Field Panels	Panel Edge	Suspension System
6"	4' (48")	8' - 6" (102")	HALCYON™ CLIMAPLUS™ 96" x 48" x 1"	SL  SQ 	DX® DX®

Module Layout

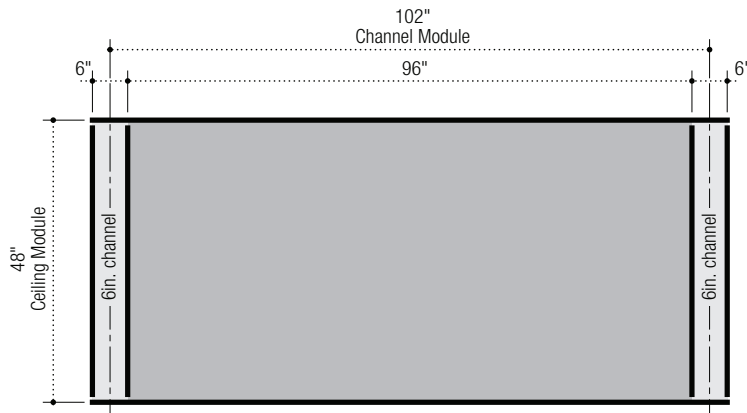

Panel Layout

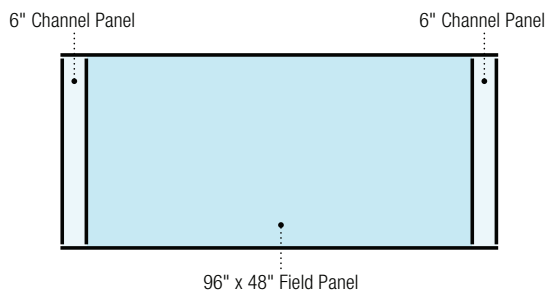

Suspension System Layout

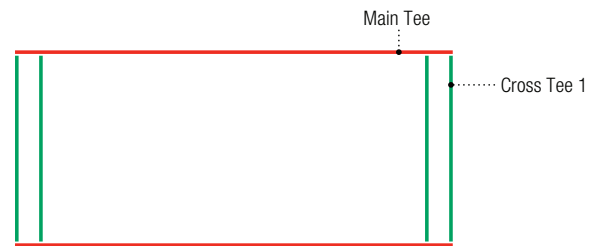

Order Information
System 979

4' Ceiling Module

6" Channel
96" x 48" Field Panel



Step 1. Select Panels

Step 2. Select Edge for Panels

			FL/FLB		SL/SLT		SQ	
			Edge	Item No.	Edge	Item No.	Edge	Item No.
Field Panels	HALCYON™ CLIMAPLUS™	96" x 48" x 1"			SL	<input type="checkbox"/> 98483	SQ	<input type="checkbox"/> 98481
Channel Panels	HALCYON™ CLIMAPLUS™	6" x 48" x 1"			SL	<input type="checkbox"/> 99271	SQ	<input type="checkbox"/> 97227
	PANZ® Metal Panels, Solid	6" x 48"			SL	<input type="checkbox"/> 256819	SQ	<input type="checkbox"/> 256768
	PANZ® Metal Panels, Perf C116	6" x 48"			SL	<input type="checkbox"/> 257248	SQ	<input type="checkbox"/> 256397
	PANZ® Metal Panels, Perf C116D	6" x 48"			SL	<input type="checkbox"/> 257584	SQ	<input type="checkbox"/> 257406

Step 3. Select Corresponding Grid for Selected Panels

			Qty	Item No.	Qty	Item No.	Qty	Item No.
Suspension Systems	DONN® DX®	Main Tee				<input type="checkbox"/> DX/DXL24		<input type="checkbox"/> DX/DXL24
		Cross Tee 1			2	<input type="checkbox"/> DX422	2	<input type="checkbox"/> DX422

Suspension System Estimator

	Length	Sq. Ft.	Main Tee Usage Per Sq. Ft.	Cross Tee 1 Usage Per Sq. Ft.	
System Module	102"	34	0.25	0.24	

Note: Multiply the ceiling area (SF) by the Usage Factor (UF). This calculation will determine lineal footage of suspension system components required. Please refer to page 11 for stabilizer bar usage.











Off-Module Channel Spacing 4' Ceiling Module

System 776

6" Channel

24" x 24" Field Panel

Selector

Channel Width	Ceiling Module	On-Center Channel Spacing	Field Panels	Panel Edge	Suspension System
6"	4' (48")	8' - 6" (102")	HALCYON™ CLIMAPLUS™ 24" x 24" x 1"	FL 	DXT™, DXI™
				SL 	DX®
				SQ 	DX®, DXT™
			MARS™ CLIMAPLUS™ 24" x 24" x 3/4"	FLB 	DXT™, DXI™
				SLT 	DX®
				SQ 	DX®, DXT™
			MARS™ CLIMAPLUS™ High-NRC 24" x 24" x 7/8"	FLB 	DXT™, DXI™
				SLT 	DX®
				SQ 	DX®, DXT™
			PANZ® Metal Panels, Solid 24" x 24"	FL 	DXT™, DXI™

Module Layout

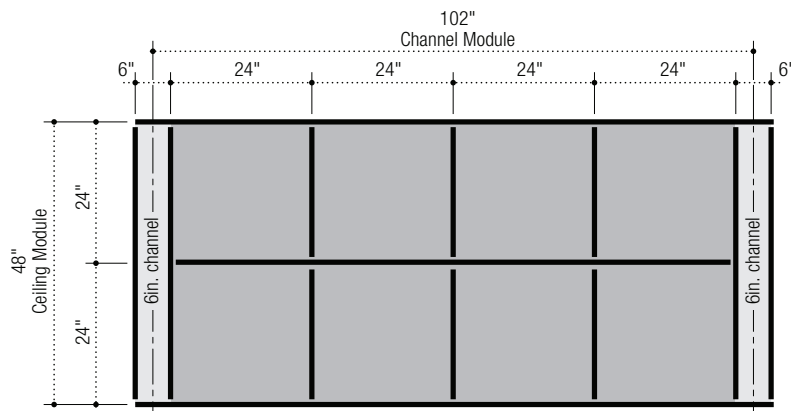

Panel Layout

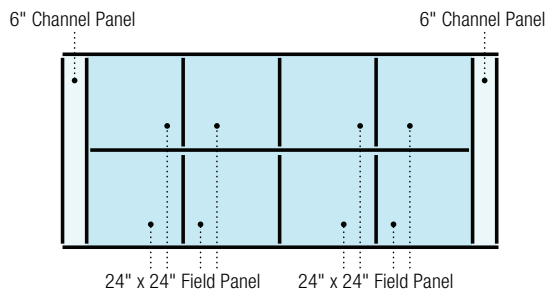

Suspension System Layout

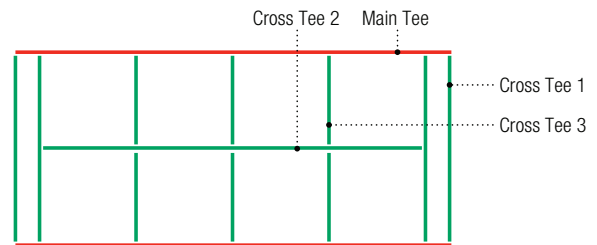

Order Information
System 776

4' Ceiling Module

6" Channel
24" x 24" Field Panel

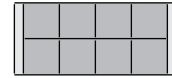

Step 1. Select Panels

Step 2. Select Edge for Panels

			FL/FLB		SL/SLT		SQ	
			Edge	Item No.	Edge	Item No.	Edge	Item No.
Field Panels	HALCYON™ CLIMAPLUS™	24" x 24" x 1"	FL	<input type="checkbox"/> 98225	SL	<input type="checkbox"/> 98223	SQ	<input type="checkbox"/> 98221
	MARS™ CLIMAPLUS™	24" x 24" x 3/4"	FLB	<input type="checkbox"/> 86985	SLT	<input type="checkbox"/> 86785	SQ	<input type="checkbox"/> 86185
	MARS™ CLIMAPLUS™ High-NRC	24" x 24" x 7/8"	FLB	<input type="checkbox"/> 87100	SLT	<input type="checkbox"/> 87200	SQ	<input type="checkbox"/> 86100
	PANZ® Metal Panels, Solid	24" x 24"	FL	<input type="checkbox"/> 275616				

Channel Panels	HALCYON™ CLIMAPLUS™	6" x 48" x 1"	FL	<input type="checkbox"/> 98198	SL	<input type="checkbox"/> 99271	SQ	<input type="checkbox"/> 97227
	MARS™ CLIMAPLUS™	6" x 48" x 3/4"	FLB	<input type="checkbox"/> 88887	SLT	<input type="checkbox"/> 86542	SQ	<input type="checkbox"/> 86325
	MARS™ CLIMAPLUS™ High-NRC	6" x 48" x 7/8"	FLB	<input type="checkbox"/> 86331	SLT	<input type="checkbox"/> 86442	SQ	<input type="checkbox"/> 86404
	PANZ® Metal Panels, Solid	6" x 48"	FL	<input type="checkbox"/> 256820	SL	<input type="checkbox"/> 256819	SQ	<input type="checkbox"/> 256768
	PANZ® Metal Panels, Perf C116	6" x 48"	FL	<input type="checkbox"/> 256062	SL	<input type="checkbox"/> 257248	SQ	<input type="checkbox"/> 256397
	PANZ® Metal Panels, Perf C116D	6" x 48"	FL	<input type="checkbox"/> 257585	SL	<input type="checkbox"/> 257584	SQ	<input type="checkbox"/> 257406

Step 3. Select Corresponding Grid for Selected Panels

			Qty	Item No.	Qty	Item No.	Qty	Item No.
Suspension Systems	CENTRICITEE™ DXT™	Main Tee		<input type="checkbox"/> DXT24				<input type="checkbox"/> DXT24
		Cross Tee 1	2	<input type="checkbox"/> DXT424			2	<input type="checkbox"/> DXT424
		Cross Tee 2	3	<input type="checkbox"/> DXT424			3	<input type="checkbox"/> DXT424
		Cross Tee 3	4	<input type="checkbox"/> DXT222			4	<input type="checkbox"/> DXT222
	IDENTITEE™ DXI™	Main Tee		<input type="checkbox"/> DXI24				
		Cross Tee 1	2	<input type="checkbox"/> DXI424				
		Cross Tee 2	3	<input type="checkbox"/> DXI424				
		Cross Tee 3	4	<input type="checkbox"/> DXI222				
	DONN® DX®	Main Tee				<input type="checkbox"/> DX/DXL24		<input type="checkbox"/> DX/DXL24
		Cross Tee 1			2	<input type="checkbox"/> DX422	2	<input type="checkbox"/> DX422
		Cross Tee 2			3	<input type="checkbox"/> DX422	3	<input type="checkbox"/> DX422
		Cross Tee 3			4	<input type="checkbox"/> DX216	4	<input type="checkbox"/> DX216

Suspension System Estimator

	Length	Sq. Ft.	Main Tee Usage Per Sq. Ft.	Cross Tee 1 Usage Per Sq. Ft.	Cross Tee 2 Usage Per Sq. Ft.	Cross Tee 3 Usage Per Sq. Ft.
System Module	102"	34	0.25	0.24	0.35	0.24

Note: Multiply the ceiling area (SF) by the Usage Factor (UF). This calculation will determine lineal footage of suspension system components required. Please refer to page 11 for stabilizer bar usage.

Off-Module Channel Spacing

4' Ceiling Module

6" Channel

System 383

120" x 24" Field Panel

Selector

Channel Width	Ceiling Module	On-Center Channel Spacing	Field Panels	Panel Edge	Suspension System
6"	4' (48")	10'-6" (126")	HALCYON™ CLIMAPLUS™ 120" x 24" x 1"	FL 	DXT™, DXI™

Module Layout

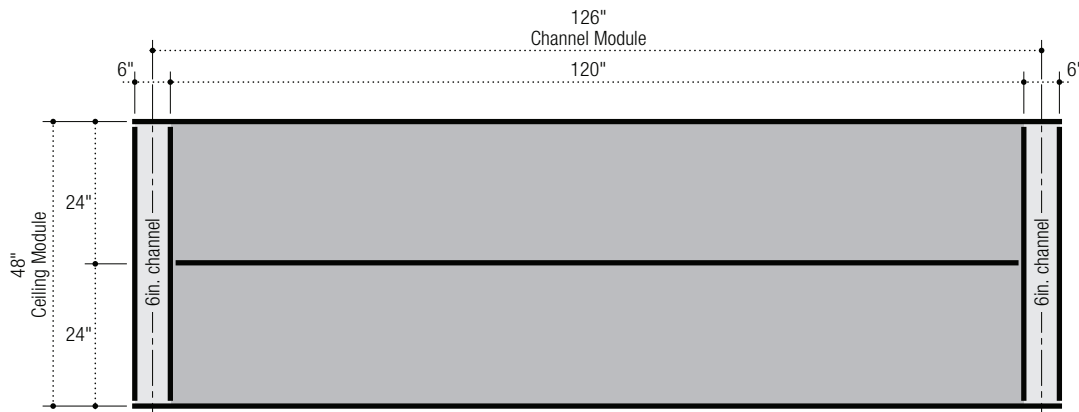

Panel Layout

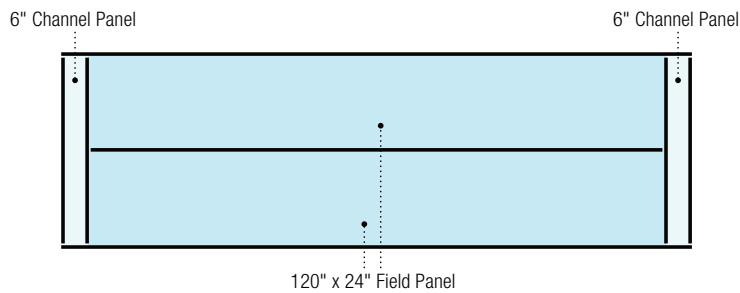

Suspension System Layout

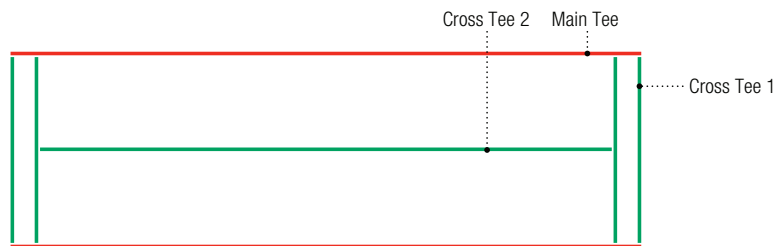

Order Information
System 383

4' Ceiling Module

6" Channel
120" x 24" Field Panel



Step 1. Select Panels

Step 2. Select Edge for Panels

			FL/FLB		SL/SLT		SQ	
			Edge	Item No.	Edge	Item No.	Edge	Item No.
Field Panels	HALCYON™ CLIMAPLUS™	120" x 24" x 1"	FL	<input type="checkbox"/> 99213				
Channel Panels	HALCYON™ CLIMAPLUS™	6" x 48" x 1"	FL	<input type="checkbox"/> 98198				
	PANZ® Metal Panels, Solid	6" x 48"	FL	<input type="checkbox"/> 256820				
	PANZ® Metal Panels, Perf C116	6" x 48"	FL	<input type="checkbox"/> 256062				
	PANZ® Metal Panels, Perf C116D	6" x 48"	FL	<input type="checkbox"/> 257585				

Step 3. Select Corresponding Grid for Selected Panels

			Qty	Item No.	Qty	Item No.	Qty	Item No.
Suspension Systems	CENTRICITEE™ DXT™	Main Tee		<input type="checkbox"/> DXT24SP110				
		Cross Tee 1	2	<input type="checkbox"/> DXT424				
		Cross Tee 2	1	<input type="checkbox"/> DXT1024				
	IDENTITEE™ DXI™	Main Tee		<input type="checkbox"/> DXI24SP110				
		Cross Tee 1	2	<input type="checkbox"/> DXI424				
		Cross Tee 2	1	<input type="checkbox"/> DXI1024				

Suspension System Estimator

	Length	Sq. Ft.	Main Tee Usage Per Sq. Ft.	Cross Tee 1 Usage Per Sq. Ft.	Cross Tee 2 Usage Per Sq. Ft.	
System Module	126"	34	0.25	0.19	0.24	

Note: Multiply the ceiling area (SF) by the Usage Factor (UF). This calculation will determine lineal footage of suspension system components required. Please refer to page 11 for stabilizer bar usage.

Off-Module Channel Spacing











5' Ceiling Module

4" Channel

System 697

30" x 60" Field Panel

Selector

Channel Width	Ceiling Module	On-Center Channel Spacing	Field Panels	Panel Edge	Suspension System
4"	5' (60")	5' - 4" (64")	HALCYON™ CLIMAPLUS™ 30" x 60" x 1"	FL 	DXT™, DXI™
				SL 	DX®
				SQ 	DX®
			MARS™ CLIMAPLUS™ 30" x 60" x 3/4"	FLB 	DXT™, DXI™
				SLT 	DX®
				SQ 	DX®
			MARS™ CLIMAPLUS™ High-NRC 30" x 60" x 7/8"	FLB 	DXT™, DXI™
				SLT 	DX®
				SQ 	DX®
			PANZ® Metal Panels, Solid 30" x 60"	FL 	DXT™, DXI™

Module Layout

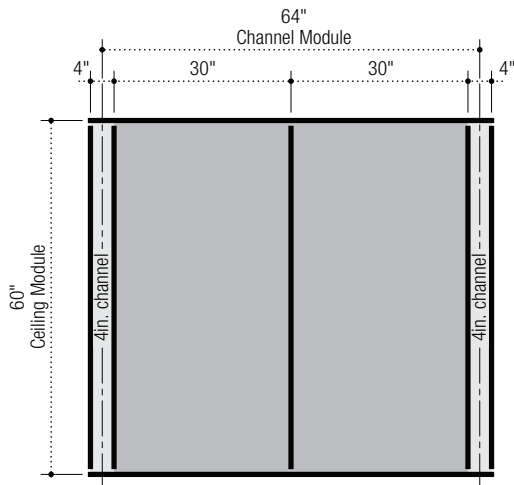

Panel Layout

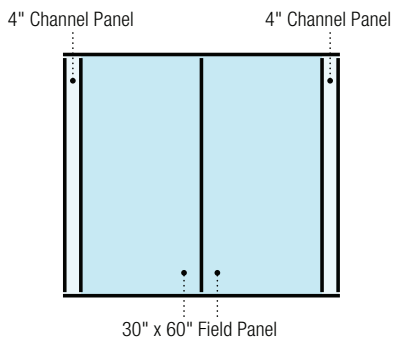

Suspension System Layout

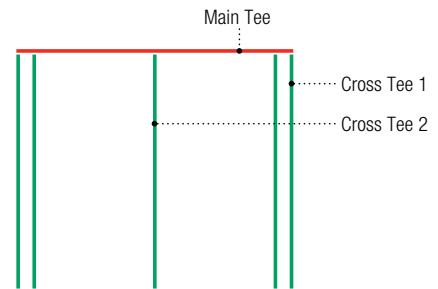

Order Information
System 697

5' Ceiling Module

4" Channel
30" x 60" Field Panel

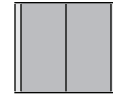

Step 1. Select Panels

Step 2. Select Edge for Panels

			FL/FLB		SL/SLT		SQ	
			Edge	Item No.	Edge	Item No.	Edge	Item No.
Field Panels	HALCYON™ CLIMAPLUS™	30" x 60" x 1"	FL	<input type="checkbox"/> 98336	SL	<input type="checkbox"/> 99270	SQ	<input type="checkbox"/> 97266
	MARS™ CLIMAPLUS™	30" x 60" x 3/4"	FLB	<input type="checkbox"/> 86267	SLT	<input type="checkbox"/> 86564	SQ	<input type="checkbox"/> 86536
	MARS™ CLIMAPLUS™ High-NRC	30" x 60" x 7/8"	FLB	<input type="checkbox"/> 86497	SLT	<input type="checkbox"/> 86466	SQ	<input type="checkbox"/> 86429
	PANZ® Metal Panels, Solid	30" x 60"	FL	<input type="checkbox"/> 212201				
Channel Panels	MARS™ CLIMAPLUS™	4" x 60" x 3/4"	FLB	<input type="checkbox"/> 86569	SLT	<input type="checkbox"/> 86541	SQ	<input type="checkbox"/> 86515
	MARS™ CLIMAPLUS™ High-NRC	4" x 60" x 7/8"	FLB	<input type="checkbox"/> 86476	SLT	<input type="checkbox"/> 86441	SQ	<input type="checkbox"/> 86403

Step 3. Select Corresponding Grid for Selected Panels

			Qty	Item No.	Qty	Item No.	Qty	Item No.
Suspension Systems	CENTRICITEE™ DXT™	Main Tee		<input type="checkbox"/> DXT24SP107				
		Cross Tee 1	2	<input type="checkbox"/> DXT524				
		Cross Tee 2	1	<input type="checkbox"/> DXT524				
	IDENTITEE™ DXI™	Main Tee		<input type="checkbox"/> DXI24SP107				
		Cross Tee 1	2	<input type="checkbox"/> DXI524				
		Cross Tee 2	1	<input type="checkbox"/> DXI524				
	DONN® DX®	Main Tee			<input type="checkbox"/> DX24SP107		<input type="checkbox"/> DX24SP107	
		Cross Tee 1			2	<input type="checkbox"/> DX524	2	<input type="checkbox"/> DX524
		Cross Tee 2			1	<input type="checkbox"/> DX524	1	<input type="checkbox"/> DX524

Suspension System Estimator

	Length	Sq. Ft.	Main Tee Usage Per Sq. Ft.	Cross Tee 1 Usage Per Sq. Ft.	Cross Tee 2 Usage Per Sq. Ft.	
System Module	64"	26.667	0.20	0.38	0.19	

Note: Multiply the ceiling area (SF) by the Usage Factor (UF). This calculation will determine lineal footage of suspension system components required. Please refer to page 11 for stabilizer bar usage.

Off-Module Channel Spacing











5' Ceiling Module

6" Channel

System 369

30" x 60" Field Panel

Selector

Channel Width	Ceiling Module	On-Center Channel Spacing	Field Panels	Panel Edge	Suspension System
6"	5' (60")	5' - 6" (66")	HALCYON™ CLIMAPLUS™ 30" x 60" x 1"	FL 	DXT™, DXI™
				SL 	DX®
				SQ 	DX®
			MARS™ CLIMAPLUS™ 30" x 60" x 3/4"	FLB 	DXT™, DXI™
				SLT 	DX®
				SQ 	DX®
			MARS™ CLIMAPLUS™ High-NRC 30" x 60" x 7/8"	FLB 	DXT™, DXI™
				SLT 	DX®
				SQ 	DX®
			PANZ® Metal Panels, Solid 30" x 60"	FL 	DXT™, DXI™

Module Layout

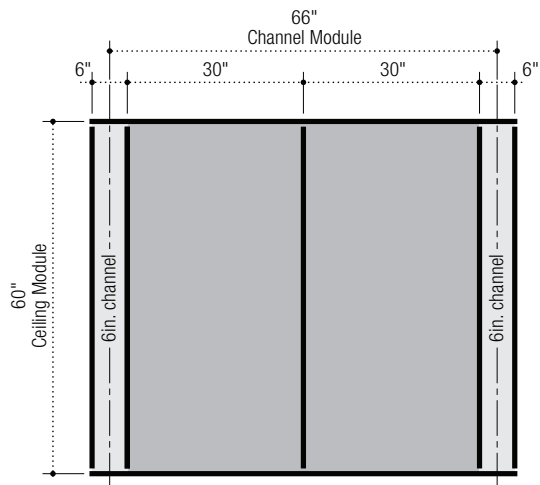

Panel Layout

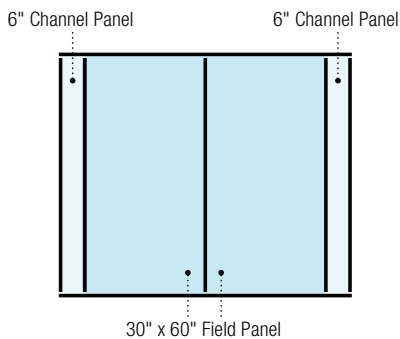

Suspension System Layout

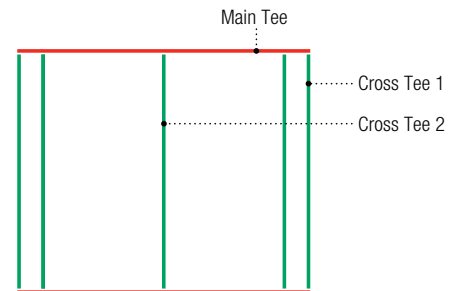

Order Information
System 369

5' Ceiling Module

6" Channel
30" x 60" Field Panel

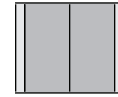

Step 1. Select Panels

Step 2. Select Edge for Panels

			FL/FLB		SL/SLT		SQ	
			Edge	Item No.	Edge	Item No.	Edge	Item No.
Field Panels	HALCYON™ CLIMAPLUS™	30" x 60" x 1"	FL	<input type="checkbox"/> 98336	SL	<input type="checkbox"/> 99270	SQ	<input type="checkbox"/> 97266
	MARS™ CLIMAPLUS™	30" x 60" x 3/4"	FLB	<input type="checkbox"/> 86267	SLT	<input type="checkbox"/> 86564	SQ	<input type="checkbox"/> 86536
	MARS™ CLIMAPLUS™ High-NRC	30" x 60" x 7/8"	FLB	<input type="checkbox"/> 86497	SLT	<input type="checkbox"/> 86466	SQ	<input type="checkbox"/> 86429
	PANZ® Metal Panels, Solid	30" x 60"	FL	<input type="checkbox"/> 212201				

Channel Panels	HALCYON™ CLIMAPLUS™	6" x 60" x 1"	FL	<input type="checkbox"/> 98199	SL	<input type="checkbox"/> 99272	SQ	<input type="checkbox"/> 97228
	MARS™ CLIMAPLUS™	6" x 60" x 3/4"	FLB	<input type="checkbox"/> 86835	SLT	<input type="checkbox"/> 86543	SQ	<input type="checkbox"/> 86507
	MARS™ CLIMAPLUS™ High-NRC	6" x 60" x 7/8"	FLB	<input type="checkbox"/> 86333	SLT	<input type="checkbox"/> 86443	SQ	<input type="checkbox"/> 86145
	PANZ® Metal Panels, Solid	6" x 60"	FL	<input type="checkbox"/> 258036	SL	<input type="checkbox"/> 257972	SQ	<input type="checkbox"/> 257586
	PANZ® Metal Panels, Perf C116	6" x 60"	FL	<input type="checkbox"/> 259228	SL	<input type="checkbox"/> 259010	SQ	<input type="checkbox"/> 259009
	PANZ® Metal Panels, Perf C116D	6" x 60"	FL	<input type="checkbox"/> 259353	SL	<input type="checkbox"/> 259344	SQ	<input type="checkbox"/> 259308

Step 3. Select Corresponding Grid for Selected Panels

			Qty	Item No.	Qty	Item No.	Qty	Item No.
Suspension Systems	CENTRICITEE™ DXT™	Main Tee		<input type="checkbox"/> DXT24				
		Cross Tee 1	2	<input type="checkbox"/> DXT524				
		Cross Tee 2	1	<input type="checkbox"/> DXT524				
	IDENTITEE™ DXI™	Main Tee		<input type="checkbox"/> DXI24				
		Cross Tee 1	2	<input type="checkbox"/> DXI524				
		Cross Tee 2	1	<input type="checkbox"/> DXI524				
	DONN® DX®	Main Tee				<input type="checkbox"/> DX/DXL24		<input type="checkbox"/> DX/DXL24
		Cross Tee 1			2	<input type="checkbox"/> DX524	2	<input type="checkbox"/> DX524
		Cross Tee 2			1	<input type="checkbox"/> DX524	1	<input type="checkbox"/> DX524

Suspension System Estimator

	Length	Sq. Ft.	Main Tee Usage Per Sq. Ft.	Cross Tee 1 Usage Per Sq. Ft.	Cross Tee 2 Usage Per Sq. Ft.	
System Module	66"	27.5	0.20	0.36	0.18	

Note: Multiply the ceiling area (SF) by the Usage Factor (UF). This calculation will determine lineal footage of suspension system components required. Please refer to page 11 for stabilizer bar usage.

Off-Module Channel Spacing











5' Ceiling Module

4" Channel

System 378

30" x 30" Field Panel

Selector

Channel Width	Ceiling Module	On-Center Channel Spacing	Field Panels	Panel Edge	Suspension System
4"	5' (60")	5' - 4" (64")	HALCYON™ CLIMAPLUS™ 30" x 30" x 1"	FL 	DXT™, DXI™
				SL 	DX®
				SQ 	DX®
			MARS™ CLIMAPLUS™ 30" x 30" x 3/4"	FLB 	DXT™, DXI™
				SLT 	DX®
				SQ 	DX®
			MARS™ CLIMAPLUS™ High-NRC 30" x 30" x 7/8"	FLB 	DXT™, DXI™
				SLT 	DX®
				SQ 	DX®
			PANZ® Metal Panels, Solid 30" x 30"	FL 	DXT™, DXI™

Module Layout

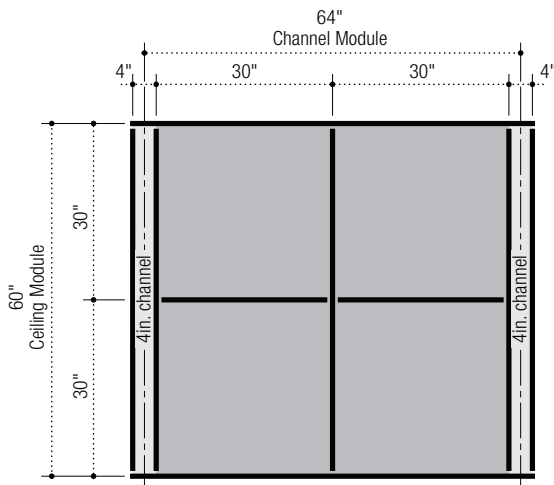

Panel Layout

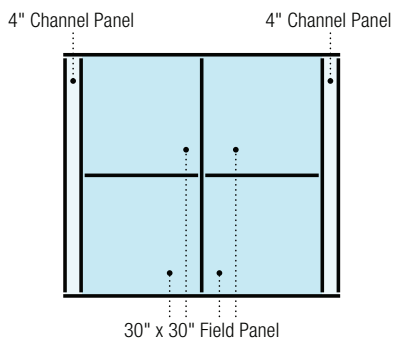

Suspension System Layout

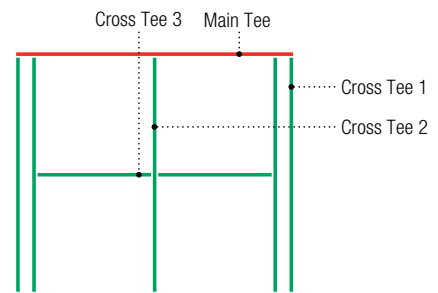

Order Information
System 378

5' Ceiling Module

4" Channel
30" x 30" Field Panel

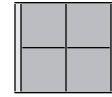

Step 1. Select Panels

Step 2. Select Edge for Panels

			FL/FLB		SL/SLT		SQ	
			Edge	Item No.	Edge	Item No.	Edge	Item No.
Field Panels	HALCYON™ CLIMAPLUS™	30" x 30" x 1"	FL	<input type="checkbox"/> 98335	SL	<input type="checkbox"/> 98333	SQ	<input type="checkbox"/> 98331
	MARS™ CLIMAPLUS™	30" x 30" x 3/4"	FLB	<input type="checkbox"/> 86830	SLT	<input type="checkbox"/> 86875	SQ	<input type="checkbox"/> 86815
	MARS™ CLIMAPLUS™ High-NRC	30" x 30" x 7/8"	FLB	<input type="checkbox"/> 86400	SLT	<input type="checkbox"/> 86500	SQ	<input type="checkbox"/> 86426
	PANZ® Metal Panels, Solid	30" x 30"	FL	<input type="checkbox"/> 212123				
Channel Panels	MARS™ CLIMAPLUS™	4" x 60" x 3/4"	FLB	<input type="checkbox"/> 86569	SLT	<input type="checkbox"/> 86541	SQ	<input type="checkbox"/> 86515
	MARS™ CLIMAPLUS™ High-NRC	4" x 60" x 7/8"	FLB	<input type="checkbox"/> 86476	SLT	<input type="checkbox"/> 86441	SQ	<input type="checkbox"/> 86403

Step 3. Select Corresponding Grid for Selected Panels

			Qty	Item No.	Qty	Item No.	Qty	Item No.
Suspension Systems	CENTRICITEE™ DXT™	Main Tee		<input type="checkbox"/> DXT24SP107				
		Cross Tee 1	2	<input type="checkbox"/> DXT524				
		Cross Tee 2	1	<input type="checkbox"/> DXT524				
		Cross Tee 3	1	<input type="checkbox"/> DXT3022				
	IDENTITEE™ DXI™	Main Tee		<input type="checkbox"/> DXI24SP107				
		Cross Tee 1	2	<input type="checkbox"/> DXI524				
		Cross Tee 2	1	<input type="checkbox"/> DXI524				
		Cross Tee 3	1	<input type="checkbox"/> DXI3022				
	DONN® DX®	Main Tee			<input type="checkbox"/> DX124SP107		<input type="checkbox"/> DX124SP107	
		Cross Tee 1			2	<input type="checkbox"/> DX524	2	<input type="checkbox"/> DX524
		Cross Tee 2			1	<input type="checkbox"/> DX524	1	<input type="checkbox"/> DX524
		Cross Tee 3			1	<input type="checkbox"/> DX3016	1	<input type="checkbox"/> DX3016

Suspension System Estimator

	Length	Sq. Ft.	Main Tee Usage Per Sq. Ft.	Cross Tee 1 Usage Per Sq. Ft.	Cross Tee 2 Usage Per Sq. Ft.	
System Module	66"	27.5	0.20	0.36	0.18	

Note: Multiply the ceiling area (SF) by the Usage Factor (UF). This calculation will determine lineal footage of suspension system components required. Please refer to page 11 for stabilizer bar usage.

Off-Module Channel Spacing











5' Ceiling Module

6" Channel

System 642

30" x 30" Field Panel

Selector

Channel Width	Ceiling Module	On-Center Channel Spacing	Field Panels	Panel Edge	Suspension System
6"	5' (60")	5' - 6" (66")	HALCYON™ CLIMAPLUS™ 30" x 30" x 1"	FL 	DXT™, DXI™
				SL 	DX®
				SQ 	DX®
			MARS™ CLIMAPLUS™ 30" x 30" x 3/4"	FLB 	DXT™, DXI™
				SLT 	DX®
				SQ 	DX®
			MARS™ CLIMAPLUS™ High-NRC 30" x 30" x 7/8"	FLB 	DXT™, DXI™
				SLT 	DX®
				SQ 	DX®
			PANZ® Metal Panels, Solid 30" x 30"	FL 	DXT™, DXI™

Module Layout

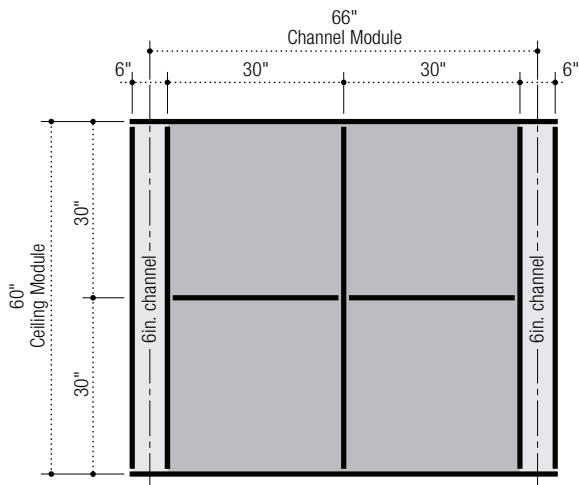

Panel Layout

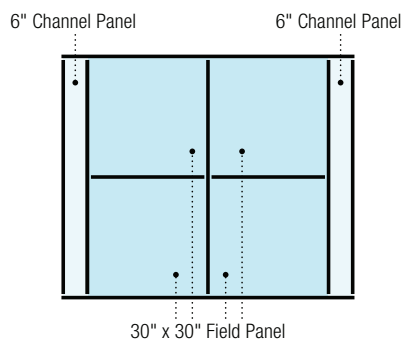

Suspension System Layout

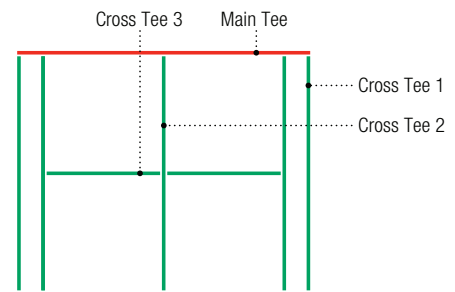

Order Information
System 642

5' Ceiling Module

6" Channel
30" x 30" Field Panel

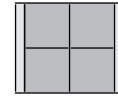

Step 1. Select Panels

Step 2. Select Edge for Panels

			FL/FLB		SL/SLT		SQ	
			Edge	Item No.	Edge	Item No.	Edge	Item No.
Field Panels	HALCYON™ CLIMAPLUS™	30" x 30" x 1"	FL	<input type="checkbox"/> 98335	SL	<input type="checkbox"/> 98333	SQ	<input type="checkbox"/> 98331
	MARS™ CLIMAPLUS™	30" x 30" x 3/4"	FLB	<input type="checkbox"/> 86830	SLT	<input type="checkbox"/> 86875	SQ	<input type="checkbox"/> 86815
	MARS™ CLIMAPLUS™ High-NRC	30" x 30" x 7/8"	FLB	<input type="checkbox"/> 86400	SLT	<input type="checkbox"/> 86500	SQ	<input type="checkbox"/> 86426
	PANZ® Metal Panels, Solid	30" x 30"	FL	<input type="checkbox"/> 212123				

Channel Panels	HALCYON™ CLIMAPLUS™	6" x 60" x 1"	FL	<input type="checkbox"/> 98199	SL	<input type="checkbox"/> 99272	SQ	<input type="checkbox"/> 97228
	MARS™ CLIMAPLUS™	6" x 60" x 3/4"	FLB	<input type="checkbox"/> 86835	SLT	<input type="checkbox"/> 86543	SQ	<input type="checkbox"/> 86507
	MARS™ CLIMAPLUS™ High-NRC	6" x 60" x 7/8"	FLB	<input type="checkbox"/> 86333	SLT	<input type="checkbox"/> 86443	SQ	<input type="checkbox"/> 86145
	PANZ® Metal Panels, Solid	6" x 60"	FL	<input type="checkbox"/> 258036	SL	<input type="checkbox"/> 257972	SQ	<input type="checkbox"/> 257586
	PANZ® Metal Panels, Perf C116	6" x 60"	FL	<input type="checkbox"/> 259228	SL	<input type="checkbox"/> 259010	SQ	<input type="checkbox"/> 259009
	PANZ® Metal Panels, Perf C116D	6" x 60"	FL	<input type="checkbox"/> 259353	SL	<input type="checkbox"/> 259344	SQ	<input type="checkbox"/> 259308

Step 3. Select Corresponding Grid for Selected Panels

			Qty	Item No.	Qty	Item No.	Qty	Item No.
Suspension Systems	CENTRICITEE™ DXT™	Main Tee		<input type="checkbox"/> DXT24				
		Cross Tee 1	2	<input type="checkbox"/> DXT524				
		Cross Tee 2	1	<input type="checkbox"/> DXT524				
		Cross Tee 3	2	<input type="checkbox"/> DXT3022				
	IDENTITEE™ DXI™	Main Tee		<input type="checkbox"/> DXI24				
		Cross Tee 1	2	<input type="checkbox"/> DXI524				
		Cross Tee 2	1	<input type="checkbox"/> DXI524				
		Cross Tee 3	2	<input type="checkbox"/> DXI3022				
	DONN® DX®	Main Tee			<input type="checkbox"/> DX/DXL24		<input type="checkbox"/> DX/DXL24	
		Cross Tee 1			2	<input type="checkbox"/> DX524	2	<input type="checkbox"/> DX524
		Cross Tee 2			1	<input type="checkbox"/> DX524	1	<input type="checkbox"/> DX524
		Cross Tee 3			2	<input type="checkbox"/> DX3016	2	<input type="checkbox"/> DX3016

Suspension System Estimator

	Length	Sq. Ft.	Main Tee Usage Per Sq. Ft.	Cross Tee 1 Usage Per Sq. Ft.	Cross Tee 2 Usage Per Sq. Ft.	Cross Tee 3 Usage Per Sq. Ft.
System Module	66"	27.5	0.20	0.36	0.18	0.18

Note: Multiply the ceiling area (SF) by the Usage Factor (UF). This calculation will determine lineal footage of suspension system components required. Please refer to page 11 for stabilizer bar usage.











Off-Module Channel Spacing 5' Ceiling Module

System 859

4" Channel

24" x 48" Field Panel

Selector

Channel Width	Ceiling Module	On-Center Channel Spacing	Field Panels	Panel Edge	Suspension System
4"	6' (72")	4' - 4" (52")	HALCYON™ CLIMAPLUS™ 24" x 48" x 1"	FL 	DXT™, DXI™
				SL 	DX®
				SQ 	DX®
			MARS™ CLIMAPLUS™ 24" x 48" x 3/4"	FLB 	DXT™, DXI™
				SLT 	DX®
				SQ 	DX®
			MARS™ CLIMAPLUS™ High-NRC 24" x 48" x 7/8"	FLB 	DXT™, DXI™
				SLT 	DX®
				SQ 	DX®
			PANZ® Metal Panels, Solid 24" x 48"	FL 	DXT™, DXI™

Module Layout

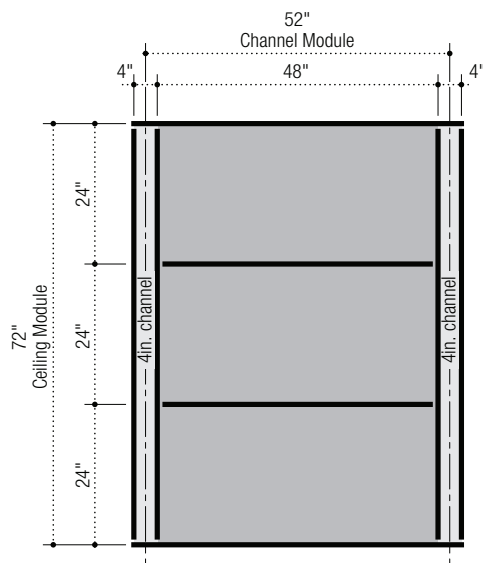

Panel Layout

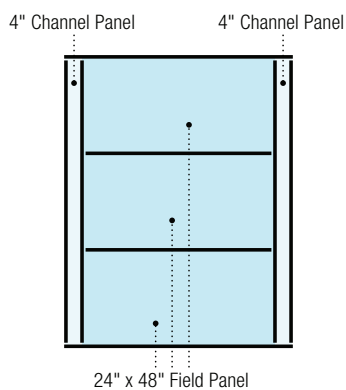

Suspension System Layout

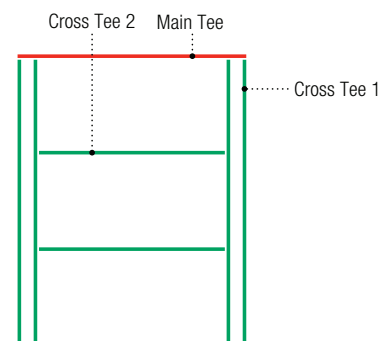

Order Information
System 859

5' Ceiling Module

4" Channel
24" x 48" Field Panel

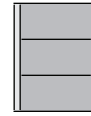

Step 1. Select Panels

Step 2. Select Edge for Panels

			FL/FLB		SL/SLT		SQ	
			Edge	Item No.	Edge	Item No.	Edge	Item No.
Field Panels	HALCYON™ CLIMAPLUS™	24" x 48" x 1"	FL	<input type="checkbox"/> 98245	SL	<input type="checkbox"/> 98243	SQ	<input type="checkbox"/> 98241
	MARS™ CLIMAPLUS™	24" x 48" x 3/4"	FLB	<input type="checkbox"/> 88985	SLT	<input type="checkbox"/> 88785	SQ	<input type="checkbox"/> 88185
	MARS™ CLIMAPLUS™ High-NRC	24" x 48" x 7/8"	FLB	<input type="checkbox"/> 89500	SLT	<input type="checkbox"/> 89600	SQ	<input type="checkbox"/> 86300
	PANZ® Metal Panels, Solid	24" x 48"	FL	<input type="checkbox"/> 212164				
Channel Panels	MARS™ CLIMAPLUS™	4" x 72" x 3/4"	FLB	<input type="checkbox"/> 86584	SLT	<input type="checkbox"/> 86565	SQ	<input type="checkbox"/> 86537
	MARS™ CLIMAPLUS™ High-NRC	4" x 72" x 7/8"	FLB	<input type="checkbox"/> 86473	SLT	<input type="checkbox"/> 86467	SQ	<input type="checkbox"/> 86405
	PANZ® Metal Panels, Solid	4" x 72"	FL	<input type="checkbox"/> 202652				

Step 3. Select Corresponding Grid for Selected Panels

			Qty	Item No.	Qty	Item No.	Qty	Item No.
Suspension Systems	CENTRICITEE™ DXT™	Main Tee		<input type="checkbox"/> DXT24SP103				
		Cross Tee 1	2	<input type="checkbox"/> DXT424				
		Cross Tee 2	1	<input type="checkbox"/> DXT424				
	IDENTITEE™ DXI™	Main Tee		<input type="checkbox"/> DXI24SP103				
		Cross Tee 1	2	<input type="checkbox"/> DXI424				
		Cross Tee 2	1	<input type="checkbox"/> DXI424				
	DONN® DX®	Main Tee			<input type="checkbox"/> DX24SP103		<input type="checkbox"/> DX24SP103	
		Cross Tee 1			2	<input type="checkbox"/> DX422	2	<input type="checkbox"/> DX422
		Cross Tee 2			2	<input type="checkbox"/> DX422	2	<input type="checkbox"/> DX422

Suspension System Estimator

	Length	Sq. Ft.	Main Tee Usage Per Sq. Ft.	Cross Tee 1 Usage Per Sq. Ft.	Cross Tee 2 Usage Per Sq. Ft.	
System Module	52"	26	0.17	.46	0.31	

Note: Multiply the ceiling area (SF) by the Usage Factor (UF). This calculation will determine lineal footage of suspension system components required. Please refer to page 11 for stabilizer bar usage.

Off-Module Channel Spacing











6' Ceiling Module

6" Channel

System 824

24" x 48" Field Panel

Selector

Channel Width	Ceiling Module	On-Center Channel Spacing	Field Panels	Panel Edge	Suspension System
6"	6' (72")	4' - 6" (54")	HALCYON™ CLIMAPLUS™ 24" x 48" x 1"	FL 	DXT™, DXI™
				SL 	DX®
				SQ 	DX®
			MARS™ CLIMAPLUS™ 24" x 48 x 3/4"	FLB 	DXT™, DXI™
				SLT 	DX®
				SQ 	DX®
			MARS™ CLIMAPLUS™ High-NRC 24" x 48" x 7/8"	FLB 	DXT™, DXI™
				SLT 	DX®
				SQ 	DX®
			PANZ® Metal Panels, Solid 24" x 48"	FL 	DXT™, DXI™

Module Layout

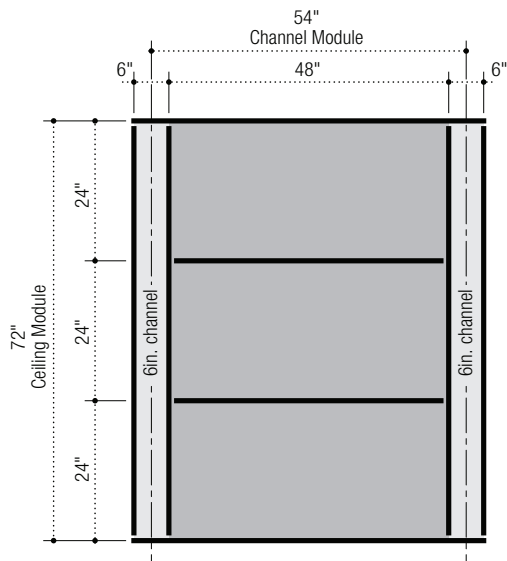

Panel Layout

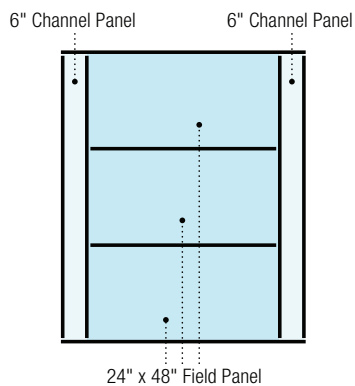

Suspension System Layout

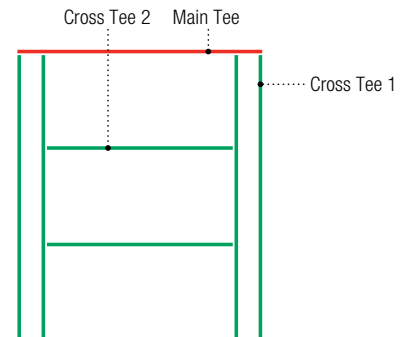

Order Information
System 824

6' Ceiling Module

6" Channel
24" x 48" Field Panel

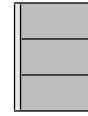

Step 1. Select Panels

Step 2. Select Edge for Panels

			FL/FLB		SL/SLT		SQ	
			Edge	Item No.	Edge	Item No.	Edge	Item No.
Field Panels	HALCYON™ CLIMAPLUS™	24" x 48" x 1"	FL	<input type="checkbox"/> 98245	SL	<input type="checkbox"/> 98243	SQ	<input type="checkbox"/> 98241
	MARS™ CLIMAPLUS™	24" x 48" x 3/4"	FLB	<input type="checkbox"/> 88985	SLT	<input type="checkbox"/> 88785	SQ	<input type="checkbox"/> 88185
	MARS™ CLIMAPLUS™ High-NRC	24" x 48" x 7/8"	FLB	<input type="checkbox"/> 89500	SLT	<input type="checkbox"/> 89600	SQ	<input type="checkbox"/> 86300
	PANZ® Metal Panels, Solid	24" x 48"	FL	<input type="checkbox"/> 212164				

Channel Panels	HALCYON™ CLIMAPLUS™	6" x 72" x 1"	FL	<input type="checkbox"/> 97574	SL	<input type="checkbox"/> 97433	SQ	<input type="checkbox"/> 97405
	MARS™ CLIMAPLUS™	6" x 72" x 3/4"	FLB	<input type="checkbox"/> 86567	SLT	<input type="checkbox"/> 86566	SQ	<input type="checkbox"/> 86538
	MARS™ CLIMAPLUS™ High-NRC	6" x 72" x 7/8"	FLB	<input type="checkbox"/> 86474	SLT	<input type="checkbox"/> 86468	SQ	<input type="checkbox"/> 86406
	PANZ® Metal Panels, Solid	6" x 72"	FL	<input type="checkbox"/> 202653				

Step 3. Select Corresponding Grid for Selected Panels

			Qty	Item No.	Qty	Item No.	Qty	Item No.
Suspension Systems	CENTRICITEE™ DXT™	Main Tee		<input type="checkbox"/> DXT24				
		Cross Tee 1	2	<input type="checkbox"/> DXT424				
		Cross Tee 2	2	<input type="checkbox"/> DXT424				
	IDENTITEE™ DXI™	Main Tee		<input type="checkbox"/> DXI24				
		Cross Tee 1	2	<input type="checkbox"/> DXI424				
		Cross Tee 2	2	<input type="checkbox"/> DXI424				
	DONN® DX®	Main Tee				<input type="checkbox"/> DX/DXL24		<input type="checkbox"/> DX/DXL24
		Cross Tee 1			2	<input type="checkbox"/> DX422	2	<input type="checkbox"/> DX422
		Cross Tee 2			2	<input type="checkbox"/> DX422	2	<input type="checkbox"/> DX422

Suspension System Estimator

	Length	Sq. Ft.	Main Tee Usage Per Sq. Ft.	Cross Tee 1 Usage Per Sq. Ft.	Cross Tee 2 Usage Per Sq. Ft.	
System Module	54"	27	0.17	0.30	0.30	

Note: Multiply the ceiling area (SF) by the Usage Factor (UF). This calculation will determine lineal footage of suspension system components required. Please refer to page 11 for stabilizer bar usage.

Off-Module Channel Spacing











6' Ceiling Module

4" Channel

System 724

24" x 24" Field Panel

Selector

Channel Width	Ceiling Module	On-Center Channel Spacing	Field Panels	Panel Edge	Suspension System
4"	6' (72")	4' - 4" (52")	HALCYON™ CLIMAPLUS™ 24" x 24" x 1"	FL 	DXT™, DXI™
				SL 	DX®
				SQ 	DX®, DXT™
			MARS™ CLIMAPLUS™ 24" x 24" x 3/4"	FLB 	DXT™, DXI™
				SLT 	DX®
				SQ 	DX®, DXT™
			MARS™ CLIMAPLUS™ High-NRC 24" x 24" x 7/8"	FLB 	DXT™, DXI™
				SLT 	DX®
				SQ 	DX®, DXT™
			PANZ® Metal Panels, Solid 24" x 24"	FL 	DXT™, DXI™

Module Layout

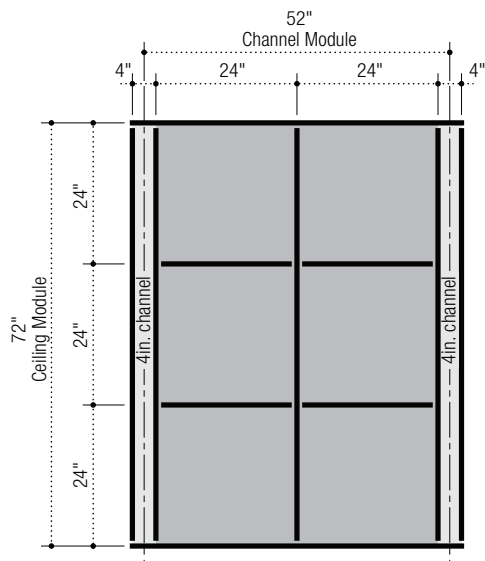

Panel Layout

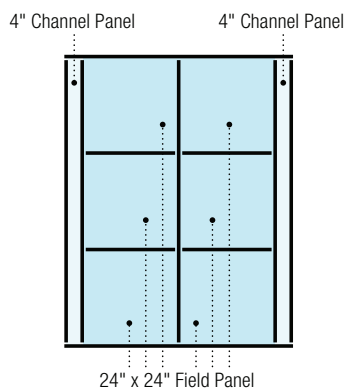

Suspension System Layout

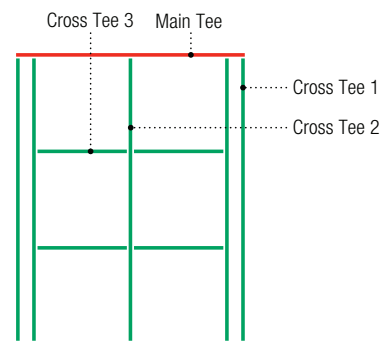

Order Information
System 724

6' Ceiling Module

4" Channel
24" x 24" Field Panel

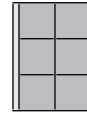

Step 1. Select Panels

Step 2. Select Edge for Panels

			FL/FLB		SL/SLT		SQ	
			Edge	Item No.	Edge	Item No.	Edge	Item No.
Field Panels	HALCYON™ CLIMAPLUS™	24" x 24" x 1"	FL	<input type="checkbox"/> 98225	SL	<input type="checkbox"/> 98223	SQ	<input type="checkbox"/> 98221
	MARS™ CLIMAPLUS™	24" x 24" x 3/4"	FLB	<input type="checkbox"/> 86985	SLT	<input type="checkbox"/> 86785	SQ	<input type="checkbox"/> 86185
	MARS™ CLIMAPLUS™ High-NRC	24" x 24" x 7/8"	FLB	<input type="checkbox"/> 87100	SLT	<input type="checkbox"/> 87200	SQ	<input type="checkbox"/> 86100
	PANZ® Metal Panels, Solid	24" x 24"	FL	<input type="checkbox"/> 275616				

Channel Panels	MARS™ CLIMAPLUS™	4" x 72" x 3/4"	FLB	<input type="checkbox"/> 86584	SLT	<input type="checkbox"/> 86565	SQ	<input type="checkbox"/> 86537
	MARS™ CLIMAPLUS™ High-NRC	4" x 72" x 7/8"	FLB	<input type="checkbox"/> 86473	SLT	<input type="checkbox"/> 86467	SQ	<input type="checkbox"/> 86405
	PANZ® Metal Panels, Solid	4" x 72"	FL	<input type="checkbox"/> 202652				

Step 3. Select Corresponding Grid for Selected Panels

			Qty	Item No.	Qty	Item No.	Qty	Item No.
Suspension Systems	CENTRICITEE™ DXT™	Main Tee		<input type="checkbox"/> DXT24SP103				<input type="checkbox"/> DXT24SP103
		Cross Tee 1	2	<input type="checkbox"/> DXT624			2	<input type="checkbox"/> DXT624
		Cross Tee 2	1	<input type="checkbox"/> DXT624			1	<input type="checkbox"/> DXT624
		Cross Tee 3	4	<input type="checkbox"/> DXT222			4	<input type="checkbox"/> DXT222
	IDENTITEE™ DXI™	Main Tee		<input type="checkbox"/> DXI24SP103				
		Cross Tee 1	2	<input type="checkbox"/> DXI624				
		Cross Tee 2	1	<input type="checkbox"/> DXI624				
		Cross Tee 3	4	<input type="checkbox"/> DXI222				
	DONN® DX®	Main Tee				<input type="checkbox"/> DX24SP103		<input type="checkbox"/> DX24SP103
		Cross Tee 1			2	<input type="checkbox"/> DX624	2	<input type="checkbox"/> DX624
		Cross Tee 2			1	<input type="checkbox"/> DX624	1	<input type="checkbox"/> DX624
		Cross Tee 3			4	<input type="checkbox"/> DX216	4	<input type="checkbox"/> DX216

Suspension System Estimator

	Length	Sq. Ft.	Main Tee Usage Per Sq. Ft.	Cross Tee 1 Usage Per Sq. Ft.	Cross Tee 2 Usage Per Sq. Ft.	Cross Tee 3 Usage Per Sq. Ft.
System Module	52"	26	0.17	0.46	0.23	0.31

Note: Multiply the ceiling area (SF) by the Usage Factor (UF). This calculation will determine lineal footage of suspension system components required. Please refer to page 11 for stabilizer bar usage.

Off-Module Channel Spacing











6' Ceiling Module

6" Channel

System 292

24" x 24" Field Panel

Selector

Channel Width	Ceiling Module	On-Center Channel Spacing	Field Panels	Panel Edge	Suspension System
6"	6' (72")	4' - 6" (54")	HALCYON™ CLIMAPLUS™ 24" x 24" x 1"	FL 	DXT™, DXI™
				SL 	DX®
				SQ 	DX®, DXT™
			MARS™ CLIMAPLUS™ 24" x 24" x 3/4"	FLB 	DXT™, DXI™
				SLT 	DX®
				SQ 	DX®, DXT™
			MARS™ CLIMAPLUS™ High-NRC 24" x 24" x 7/8"	FLB 	DXT™, DXI™
				SLT 	DX®
				SQ 	DX®, DXT™
			PANZ® Metal Panels, Solid 24" x 24"	FL 	DXT™, DXI™

Module Layout

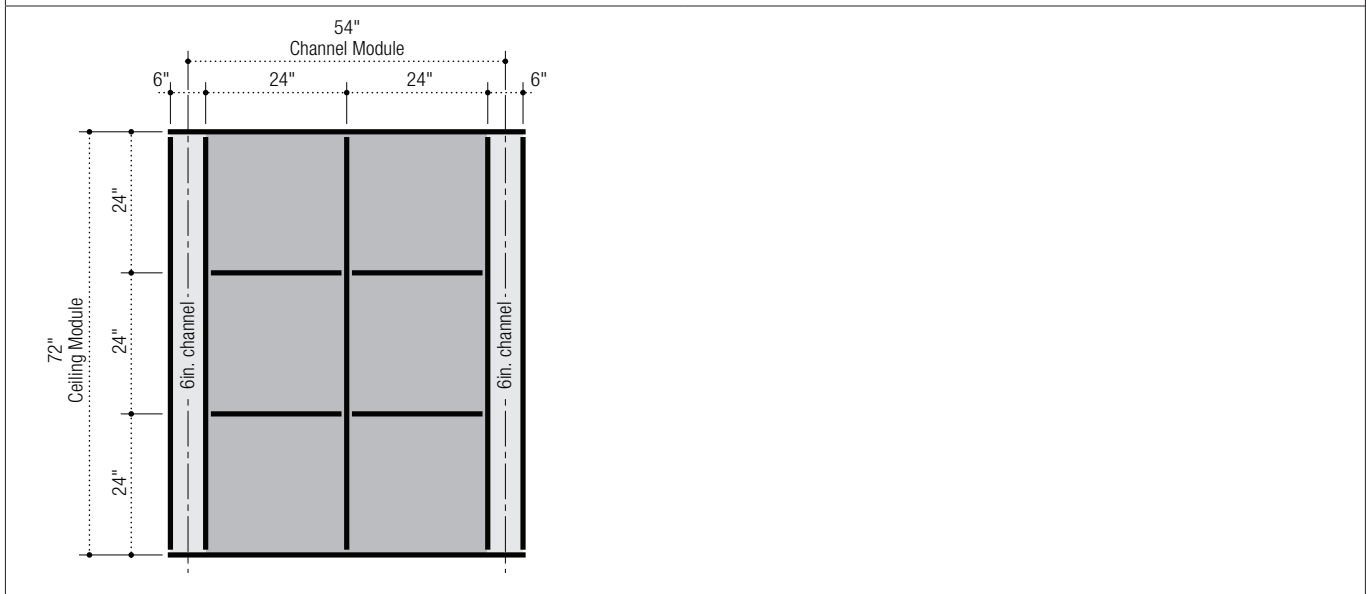

Panel Layout

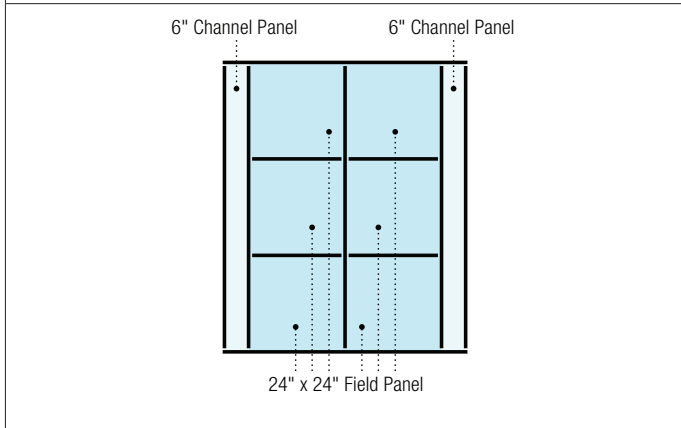

Suspension System Layout

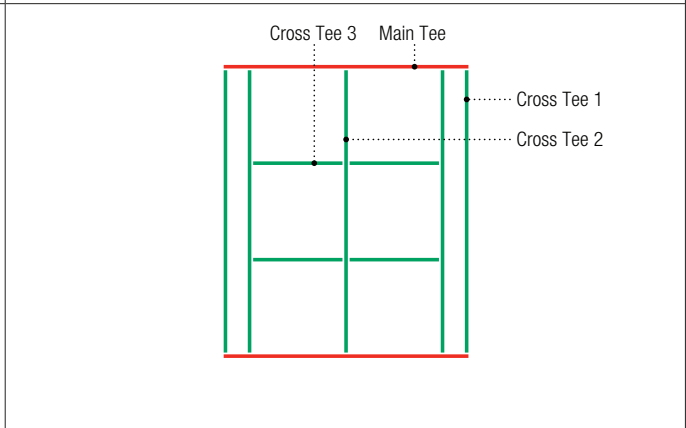

Order Information
System 292

6' Ceiling Module

6" Channel
24" x 24" Field Panel

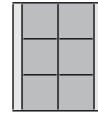

Step 1. Select Panels

Step 2. Select Edge for Panels

			FL/FLB		SL/SLT		SQ	
			Edge	Item No.	Edge	Item No.	Edge	Item No.
Field Panels	HALCYON™ CLIMAPLUS™	24" x 24" x 1"	FL	<input type="checkbox"/> 98225	SL	<input type="checkbox"/> 98223	SQ	<input type="checkbox"/> 98221
	MARS™ CLIMAPLUS™	24" x 24" x 3/4"	FLB	<input type="checkbox"/> 86985	SLT	<input type="checkbox"/> 86785	SQ	<input type="checkbox"/> 86185
	MARS™ CLIMAPLUS™ High-NRC	24" x 24" x 7/8"	FLB	<input type="checkbox"/> 87100	SLT	<input type="checkbox"/> 87200	SQ	<input type="checkbox"/> 86100
	PANZ® Metal Panels, Solid	24" x 24"	FL	<input type="checkbox"/> 275616				

Channel Panels	HALCYON™ CLIMAPLUS™	6" x 72" x 1"	FL	<input type="checkbox"/> 97574	SL	<input type="checkbox"/> 97433	SQ	<input type="checkbox"/> 97405
	MARS™ CLIMAPLUS™	6" x 72" x 3/4"	FLB	<input type="checkbox"/> 86567	SLT	<input type="checkbox"/> 86566	SQ	<input type="checkbox"/> 86538
	MARS™ CLIMAPLUS™ High-NRC	6" x 72" x 7/8"	FLB	<input type="checkbox"/> 86474	SLT	<input type="checkbox"/> 86468	SQ	<input type="checkbox"/> 86406
	PANZ® Metal Panels, Solid	6" x 72"	FL	<input type="checkbox"/> 202653				

Step 3. Select Corresponding Grid for Selected Panels

			Qty	Item No.	Qty	Item No.	Qty	Item No.
Suspension Systems	CENTRICITEE™ DXT™	Main Tee		<input type="checkbox"/> DXT24				<input type="checkbox"/> DXT24
		Cross Tee 1	2	<input type="checkbox"/> DXT624			2	<input type="checkbox"/> DXT624
		Cross Tee 2	1	<input type="checkbox"/> DXT624			1	<input type="checkbox"/> DXT624
		Cross Tee 3	4	<input type="checkbox"/> DXT222			4	<input type="checkbox"/> DXT222
	IDENTITEE™ DXI™	Main Tee		<input type="checkbox"/> DXI24				
		Cross Tee 1	2	<input type="checkbox"/> DXI624				
		Cross Tee 2	1	<input type="checkbox"/> DXI624				
		Cross Tee 3	4	<input type="checkbox"/> DXI222				
	DONN® DX®	Main Tee				<input type="checkbox"/> DX/DXL24		<input type="checkbox"/> DX/DXL24
		Cross Tee 1			2	<input type="checkbox"/> DX624	2	<input type="checkbox"/> DX624
		Cross Tee 2			1	<input type="checkbox"/> DX624	1	<input type="checkbox"/> DX624
		Cross Tee 3			4	<input type="checkbox"/> DX216	4	<input type="checkbox"/> DX216

Suspension System Estimator

	Length	Sq. Ft.	Main Tee Usage Per Sq. Ft.	Cross Tee 1 Usage Per Sq. Ft.	Cross Tee 2 Usage Per Sq. Ft.	Cross Tee 3 Usage Per Sq. Ft.
System Module	54"	27	0.17	0.44	0.22	0.30

Note: Multiply the ceiling area (SF) by the Usage Factor (UF). This calculation will determine lineal footage of suspension system components required. Please refer to page 11 for stabilizer bar usage.

Off-Module Channel Spacing











6' Ceiling Module

4" Channel

System 562

24" x 72" Field Panel

Selector

Channel Width	Ceiling Module	On-Center Channel Spacing	Field Panels	Panel Edge	Suspension System
4"	6' (72")	4' - 4" (52")	HALCYON™ CLIMAPLUS™ 24" x 72" x 1"	FL 	DXT™, DXI™
				SL 	DX®
				SQ 	DX®
			MARS™ CLIMAPLUS™ 24" x 72" x 3/4"	FLB 	DXT™, DXI™
				SLT 	DX®
				SQ 	DX®
			MARS™ CLIMAPLUS™ High-NRC 24" x 72" x 7/8"	FLB 	DXT™, DXI™
				SLT 	DX®
				SQ 	DX®
			PANZ® Metal Panels, Solid 24" x 72"	FL 	DXT™, DXI™

Module Layout

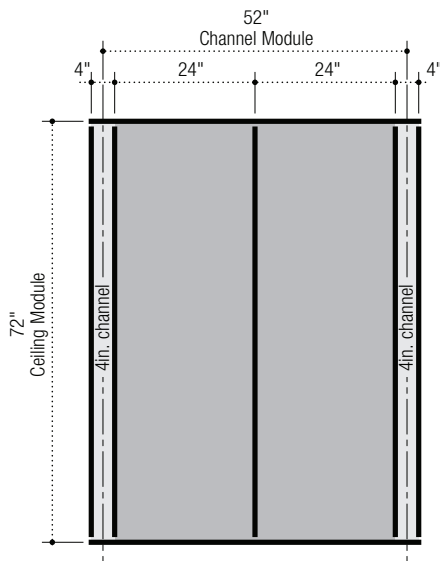

Panel Layout

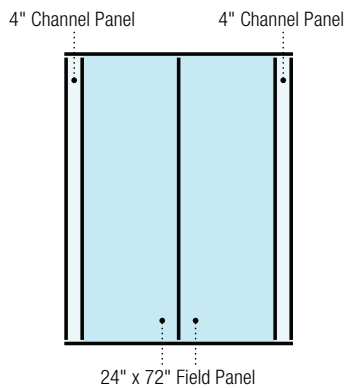

Suspension System Layout

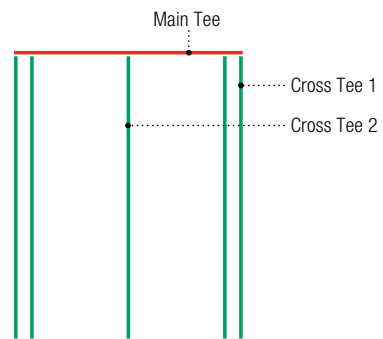

Order Information
System 562

6' Ceiling Module

4" Channel
24" x 72" Field Panel

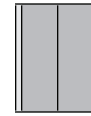

Step 1. Select Panels

Step 2. Select Edge for Panels

			FL/FLB		SL/SLT		SQ	
			Edge	Item No.	Edge	Item No.	Edge	Item No.
Field Panels	HALCYON™ CLIMAPLUS™	24" x 72" x 1"	FL	<input type="checkbox"/> 98348	SL	<input type="checkbox"/> 99268	SQ	<input type="checkbox"/> 99234
	MARS™ CLIMAPLUS™	24" x 72" x 3/4"	FLB	<input type="checkbox"/> 88996	SLT	<input type="checkbox"/> 86166	SQ	<input type="checkbox"/> 86223
	MARS™ CLIMAPLUS™ High-NRC	24" x 72" x 7/8"	FLB	<input type="checkbox"/> 89670	SLT	<input type="checkbox"/> 89660	SQ	<input type="checkbox"/> 86360
	PANZ® Metal Panels, Solid	24" x 72"	FL	<input type="checkbox"/> 212192				
Channel Panels	MARS™ CLIMAPLUS™	4" x 72" x 3/4"	FLB	<input type="checkbox"/> 86584	SLT	<input type="checkbox"/> 86565	SQ	<input type="checkbox"/> 86537
	MARS™ CLIMAPLUS™ High-NRC	4" x 72" x 7/8"	FLB	<input type="checkbox"/> 86473	SLT	<input type="checkbox"/> 86467	SQ	<input type="checkbox"/> 86405
	PANZ® Metal Panels, Solid	4" x 72"	FL	<input type="checkbox"/> 202652				

Step 3. Select Corresponding Grid for Selected Panels

			Qty	Item No.	Qty	Item No.	Qty	Item No.
Suspension Systems	CENTRICITEE™ DXT™	Main Tee		<input type="checkbox"/> DXT24SP103				
		Cross Tee 1	2	<input type="checkbox"/> DXT624				
		Cross Tee 2	1	<input type="checkbox"/> DXT624				
	IDENTITEE™ DXI™	Main Tee		<input type="checkbox"/> DXI24SP103				
		Cross Tee 1	2	<input type="checkbox"/> DXI624				
		Cross Tee 2	1	<input type="checkbox"/> DXI624				
	DONN® DX®	Main Tee			<input type="checkbox"/> DX24SP103		<input type="checkbox"/> DX24SP103	
		Cross Tee 1			2	<input type="checkbox"/> DX624	2	<input type="checkbox"/> DX624
		Cross Tee 2			1	<input type="checkbox"/> DX624	1	<input type="checkbox"/> DX624

Suspension System Estimator

	Length	Sq. Ft.	Main Tee Usage Per Sq. Ft.	Cross Tee 1 Usage Per Sq. Ft.	Cross Tee 2 Usage Per Sq. Ft.	
System Module	52"	26	0.17	0.46	0.23	

Note: Multiply the ceiling area (SF) by the Usage Factor (UF). This calculation will determine lineal footage of suspension system components required. Please refer to page 11 for stabilizer bar usage.

Off-Module Channel Spacing











4' Ceiling Module

6" Channel

System 643

24" x 72" Field Panel

Selector

Channel Width	Ceiling Module	On-Center Channel Spacing	Field Panels	Panel Edge	Suspension System
6"	6' (72")	4' - 6" (54")	HALCYON™ CLIMAPLUS™ 24" x 72" x 1"	FL 	DXT™, DXI™
				SL 	DX®
				SQ 	DX®
			MARS™ CLIMAPLUS™ 24" x 72" x 3/4"	FLB 	DXT™, DXI™
				SLT 	DX®
				SQ 	DX®
			MARS™ CLIMAPLUS™ High-NRC 24" x 72" x 7/8"	FLB 	DXT™, DXI™
				SLT 	DX®
				SQ 	DX®
			PANZ® Metal Panels, Solid 24" x 72"	FL 	DXT™, DXI™

Module Layout

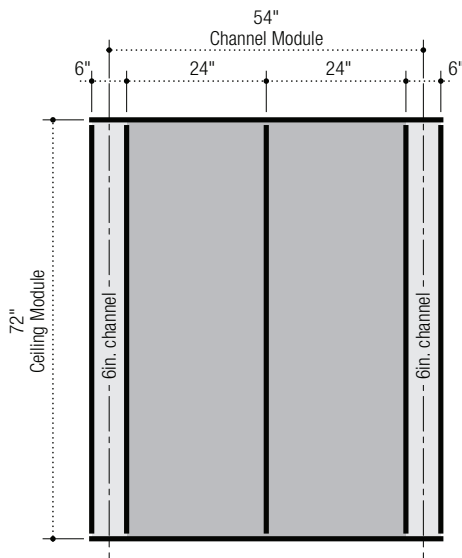

Panel Layout

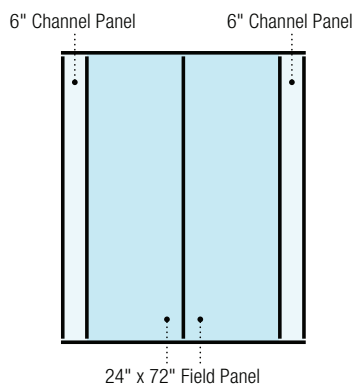

Suspension System Layout

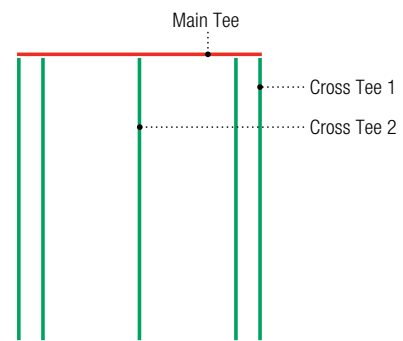

Order Information
System 643

4' Ceiling Module

6" Channel
24" x 72" Field Panel

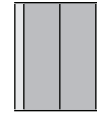

Step 1. Select Panels

Step 2. Select Edge for Panels

			FL/FLB		SL/SLT		SQ	
			Edge	Item No.	Edge	Item No.	Edge	Item No.
Field Panels	HALCYON™ CLIMAPLUS™	24" x 72" x 1"	FL	<input type="checkbox"/> 98348	SL	<input type="checkbox"/> 99268	SQ	<input type="checkbox"/> 99234
	MARS™ CLIMAPLUS™	24" x 72" x 3/4"	FLB	<input type="checkbox"/> 88996	SLT	<input type="checkbox"/> 86166	SQ	<input type="checkbox"/> 86223
	MARS™ CLIMAPLUS™ High-NRC	24" x 72" x 7/8"	FLB	<input type="checkbox"/> 89670	SLT	<input type="checkbox"/> 89660	SQ	<input type="checkbox"/> 86360
	PANZ® Metal Panels, Solid	24" x 72"	FL	<input type="checkbox"/> 212192				

Channel Panels	HALCYON™ CLIMAPLUS™	6" x 72" x 1"	FL	<input type="checkbox"/> 97574	SL	<input type="checkbox"/> 97433	SQ	<input type="checkbox"/> 97405
	MARS™ CLIMAPLUS™	6" x 72" x 3/4"	FLB	<input type="checkbox"/> 86567	SLT	<input type="checkbox"/> 86566	SQ	<input type="checkbox"/> 86538
	MARS™ CLIMAPLUS™ High-NRC	6" x 72" x 7/8"	FLB	<input type="checkbox"/> 86474	SLT	<input type="checkbox"/> 86468	SQ	<input type="checkbox"/> 86406
	PANZ® Metal Panels, Solid	6" x 72"	FL	<input type="checkbox"/> 202653				

Step 3. Select Corresponding Grid for Selected Panels

			Qty	Item No.	Qty	Item No.	Qty	Item No.
Suspension Systems	CENTRICITEE™ DXT™	Main Tee		<input type="checkbox"/> DXT24				
		Cross Tee 1	2	<input type="checkbox"/> DXT624				
		Cross Tee 2	1	<input type="checkbox"/> DXT624				
	IDENTITEE™ DXI™	Main Tee		<input type="checkbox"/> DXI24				
		Cross Tee 1	2	<input type="checkbox"/> DXI624				
		Cross Tee 2	1	<input type="checkbox"/> DXI624				
	DONN® DX®	Main Tee			<input type="checkbox"/> DX/DXL24		<input type="checkbox"/> DX/DXL24	
		Cross Tee 1			2	<input type="checkbox"/> DX624	2	<input type="checkbox"/> DX624
		Cross Tee 2			1	<input type="checkbox"/> DX624	1	<input type="checkbox"/> DX624









Suspension System Estimator

	Length	Sq. Ft.	Main Tee Usage Per Sq. Ft.	Cross Tee 1 Usage Per Sq. Ft.	Cross Tee 2 Usage Per Sq. Ft.	
System Module	54"	27	0.17	0.44	0.22	

Note: Multiply the ceiling area (SF) by the Usage Factor (UF). This calculation will determine lineal footage of suspension system components required. Please refer to page 11 for stabilizer bar usage.



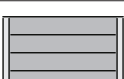

Metric Systems

100mm Channels

	Channel Width	Ceiling Module	On-Center Channel Spacing	Field Panels	PANZ® Metal Option		System	Page
					Field Panel	Channel Panel		
1000mm Ceiling Module								
	100mm	1000mm	1500mm	1400mm x 500mm	●	●	132	132-133
	100mm	1000mm	1500mm	1400mm x 1000mm		●	116	134-135
1200mm Ceiling Module								
	100mm	1200mm	1200mm	550mm x 600mm	●	●	121	136-137
	100mm	1200mm	1200mm	1100mm x 600mm	●	●	134	138-139
	100mm	1200mm	1200mm	1100mm x 1200mm		●	105	140-141
	100mm	1200mm	1300mm	1200mm x 600mm	●	●	112	142-143
	100mm	1200mm	1300mm	1200mm x 1200mm		●	108	144-145
	100mm	1200mm	1900mm	1800mm x 300mm	●	●	141	146-147
	100mm	1200mm	1900mm	1800mm x 600mm	●	●	139	148-149









Metric Systems

100mm Channels

	Channel Width	Ceiling Module	On-Center Channel Spacing	Field Panels	PANZ® Metal Option		System	Page
					Field Panel	Channel Panel		
1500mm Ceiling Module								
	100mm	1500mm	1500mm	700mm x 750mm	●	●	124	150-151
	100mm	1500mm	1500mm	1400mm x 750mm	●	●	110	152-153
	100mm	1500mm	1500mm	1400mm x 500mm	●	●	102	154-155
	100mm	1500mm	1500mm	1400mm x 1500mm		●	129	156-157

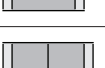
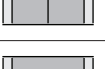

Metric Systems

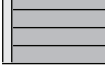
150mm Channels

	Channel Width	Ceiling Module	On-Center Channel Spacing	Field Panels	PANZ® Metal, Solid		System	Page
					Field Panel	Channel Panel		
1000mm Ceiling Module								
	150mm	1000mm	1500mm	675mm x 500mm	●	●	136	158-159
	150mm	1000mm	1500mm	1350mm x 500mm		●	122	160-161
	150mm	1000mm	1500mm	1350mm x 1000mm		●	107	162-163
1200mm Ceiling Module								
	150mm	1200mm	1200mm	525mm x 600mm		●	113	164-165
	150mm	1200mm	1200mm	1050mm x 600mm		●	109	166-167
	150mm	1200mm	1200mm	1050mm x 1200mm		●	101	168-169
	150mm	1200mm	1350mm	600mm x 600mm	●	●	127	170-171
	150mm	1200mm	1350mm	1200mm x 600mm	●	●	130	172-173
	150mm	1200mm	1350mm	1200mm x 1200mm		●	106	174-175
	150mm	1200mm	1950mm	1800mm x 300mm	●	●	120	176-177
	150mm	1200mm	1950mm	1800mm x 600mm	●	●	137	178-179

Metric Systems

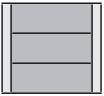
150mm Channels

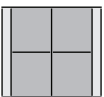
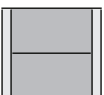
	Channel Width	Ceiling Module	On-Center Channel Spacing	Field Panels	PANZ® Metal, Solid		System	Page
					Field Panel	Channel Panel		
1500mm Ceiling Module								
	150mm	1500mm	1500mm	1350mm x 500mm	●		114	180-181
	150mm	1500mm	1500mm	1350mm x 1500mm			145	182-183
	150mm	1500mm	1500mm	675mm x 750mm			143	184-185
	150mm	1500mm	1500mm	1350mm x 750mm	●		104	186-187











Metric Systems
System 132

1000mm Ceiling Module

100mm Channel

1400mm x 500mm Field Panel

Selector

Channel Width	Ceiling Module	On-Center Channel Spacing	Field Panels	Panel Edge	Suspension System
100mm	1000mm	1500mm	HALCYON™ CLIMAPLUS™ 14000mm x 500mm	FL 	DXT™, DXI™, DXF™
				SL 	DX®
				SQ 	DX®
			MARS™ CLIMAPLUS™ 14000mm x 500mm	FLB 	DXT™, DXI™, DXF™
				SLT 	DX®
				SQ 	DX®
			MARS™ CLIMAPLUS™ High-NRC 14000mm x 500mm	FLB 	DXT™, DXI™, DXF™
				SLT 	DX®
				SQ 	DX®
			PANZ® Metal Panels, Solid 14000mm x 500mm	FL 	DXT™, DXI™

Module Layout

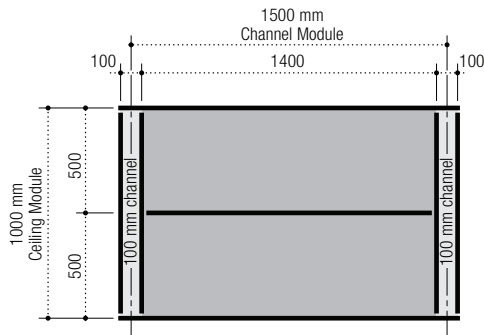

Panel Layout

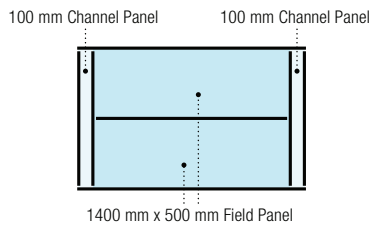

Suspension System Layout

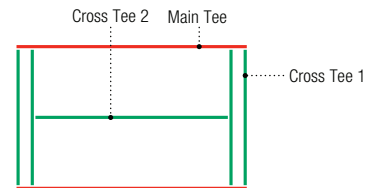



Step 1. Select Panels

Step 2. Select Edge for Panels

			FL/FLB		SL/SLT		SQ	
			Edge	Item No.	Edge	Item No.	Edge	Item No.
Field Panels	HALCYON™ CLIMAPLUS™	1400mm x 500mm	FL	<input type="checkbox"/> ME97464	SL	<input type="checkbox"/> ME97437	SQ	<input type="checkbox"/> ME97408
	MARS™ CLIMAPLUS™	1400mm x 500mm	FLB	<input type="checkbox"/> ME86571	SLT	<input type="checkbox"/> ME86548	SQ	<input type="checkbox"/> ME86520
	MARS™ CLIMAPLUS™ High-NRC	1400mm x 500mm	FLB	<input type="checkbox"/> ME86480	SLT	<input type="checkbox"/> ME86448	SQ	<input type="checkbox"/> ME86411
	PANZ® Metal Panels, Solid	1400mm x 500mm	FL	<input type="checkbox"/> ME909964				
Channel Panels	PANZ® Metal Panels, Solid	100mm x 1000mm	FL	<input type="checkbox"/> ME99946				

Step 3. Select Corresponding Grid for Selected Panels

			Qty	Item No.	Qty	Item No.	Qty	Item No.
Suspension Systems	CENTRICITEE™ DXT™	Main Tee		<input type="checkbox"/> MEDXT24SP205				
		Cross Tee 1	2	<input type="checkbox"/> MEDXT1000				
		Cross Tee 2	1	<input type="checkbox"/> MEDXT1000				
		Cross Tee 3	2	<input type="checkbox"/> MEDXT700				
	IDENTITEE™ DXI™	Main Tee		<input type="checkbox"/> MEDXI24SP205				
		Cross Tee 1	2	<input type="checkbox"/> MEDXI1000				
		Cross Tee 2	1	<input type="checkbox"/> MEDXI1000				
		Cross Tee 3	2	<input type="checkbox"/> MEDXI700				
	DONN® DX®	Main Tee			1	<input type="checkbox"/> MEDX24SP205		<input type="checkbox"/> MEDX24SP205
		Cross Tee 1			2	<input type="checkbox"/> MEDX1000	2	<input type="checkbox"/> MEDX1000
		Cross Tee 2			1	<input type="checkbox"/> MEDX1000	1	<input type="checkbox"/> MEDX1000
		Cross Tee 3			2	<input type="checkbox"/> MEDX700	2	<input type="checkbox"/> MEDX700

Suspension System Estimator

	Length	m ²	Main Tee Usage Per m ²	Cross Tee 1 Usage Per m ²	Cross Tee 2 Usage Per m ²	Cross Tee 3 Usage Per m ²
System Module	1500mm	1.500	1.000	1.333	0.667	0.933

Note: Multiply the ceiling area (SF) by the Usage Factor (UF). This calculation will determine lineal footage of suspension system components required. Please refer to page 11 for stabilizer bar usage.

Metric Systems



1000mm Ceiling Module

100mm Channel

System 116

1400mm x 1000mm Field Panel

Selector

Channel Width	Ceiling Module	On-Center Channel Spacing	Field Panels	Panel Edge	Suspension System
100mm	1000mm	1500mm	HALCYON™ CLIMAPLUS™ 1400mm x 1000mm	FL 	DXT™, DXI™, DXF™
				SL 	DX®
				SQ 	DX®

Module Layout

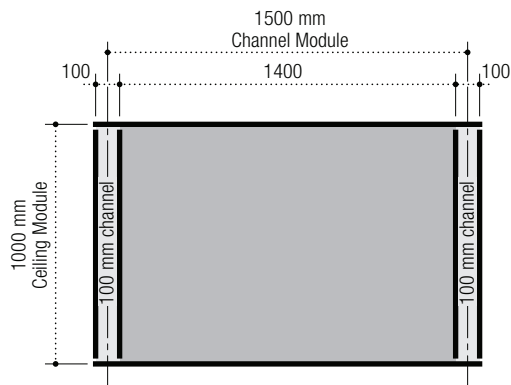

Panel Layout

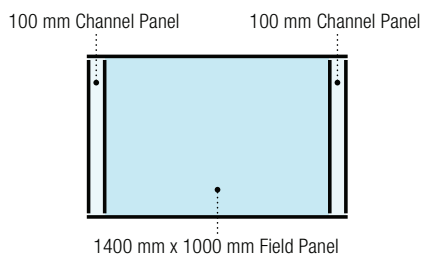

Suspension System Layout

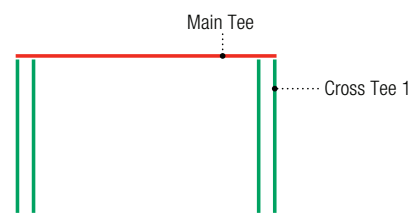

Order Information
System 116

1000mm Ceiling Module

100mm Channel

1400mm x 1000mm Field Panel

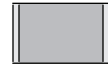

Step 1. Select Panels

Step 2. Select Edge for Panels

			FL/FLB		SL/SLT		SQ	
			Edge	Item No.	Edge	Item No.	Edge	Item No.
Field Panels	HALCYON™ CLIMAPLUS™	1400mm x 1000mm	FL	<input type="checkbox"/> ME97559	SL	<input type="checkbox"/> ME97530	SQ	<input type="checkbox"/> ME97502

Channel Panels	PANZ® Metal Panels, Solid	100mm x 1000mm	FL	<input type="checkbox"/> ME909946				
-----------------------	---------------------------	----------------	----	-----------------------------------	--	--	--	--

Step 3. Select Corresponding Grid for Selected Panels









			Qty	Item No.	Qty	Item No.	Qty	Item No.
Suspension Systems	CENTRICITEE™ DXT™	Main Tee		<input type="checkbox"/> MEDXT24SP205				
		Cross Tee 1	2	<input type="checkbox"/> MEDXT1000				
		Cross Tee 2	1	<input type="checkbox"/> MEDXT1400				
	IDENTITEE™ DXI™	Main Tee		<input type="checkbox"/> MEDXI24SP205				
		Cross Tee 1	2	<input type="checkbox"/> MEDXI1000				
		Cross Tee 2	1	<input type="checkbox"/> MEDXI1400				
	DONN® DX®	Main Tee			<input type="checkbox"/> MEDX24SP205		<input type="checkbox"/> MEDX24SP205	
		Cross Tee 1			2	<input type="checkbox"/> MEDX1000	2	<input type="checkbox"/> MEDX1000
		Cross Tee 2			1	<input type="checkbox"/> MEDX1400	1	<input type="checkbox"/> MEDX1400

Suspension System Estimator

	Length	m ²	Main Tee Usage Per m ²	Cross Tee 1 Usage Per m ²	Cross Tee 2 Usage Per m ²	
System Module	1500mm	1.500	1.000	1.333	0.933	

Note: Multiply the ceiling area (SF) by the Usage Factor (UF). This calculation will determine lineal footage of suspension system components required. Please refer to page 11 for stabilizer bar usage.

Selector

Channel Width	Ceiling Module	On-Center Channel Spacing	Field Panels	Panel Edge	Suspension System
100mm	1200mm	1200mm	HALCYON™ CLIMAPLUS™ 600mm x 550mm	FL 	DXT™, DXI™, DXF™
				SL 	DX®
				SQ 	DX®, DXT™
			MARS™ CLIMAPLUS™ 600mm x 550mm	FLB 	DXT™, DXI™, DXF™
				SLT 	DX®
				SQ 	DX®, DXT™
			MARS™ CLIMAPLUS™ High-NRC 600mm x 550mm	FLB 	DXT™, DXI™, DXF™
				SLT 	DX®
				SQ 	DX®, DXT™

Module Layout

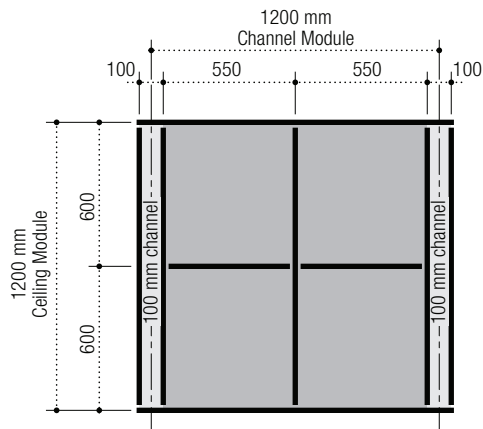

Panel Layout

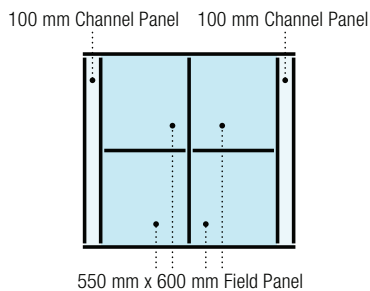

Suspension System Layout

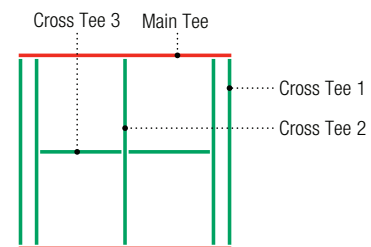

Order Information
System 121

1200mm Ceiling Module

100mm Channel

550mm x 600mm Field Panel



Step 1. Select Panels

Step 2. Select Edge for Panels

			FL/FLB		SL/SLT		SQ	
			Edge	Item No.	Edge	Item No.	Edge	Item No.
Field Panels	HALCYON™ CLIMAPLUS™	550mm x 600mm	FL	<input type="checkbox"/> ME97468	SL	<input type="checkbox"/> ME97440	SQ	<input type="checkbox"/> ME97413
	MARS™ CLIMAPLUS™	550mm x 600mm	FLB	<input type="checkbox"/> ME86574	SLT	<input type="checkbox"/> ME86552	SQ	<input type="checkbox"/> ME86524
	MARS™ CLIMAPLUS™ High-NRC	550mm x 600mm	FLB	<input type="checkbox"/> ME86485	SLT	<input type="checkbox"/> ME86453	SQ	<input type="checkbox"/> ME86416
	PANZ® Metal Panels, Solid	550mm x 600mm	FL	<input type="checkbox"/> ME909965				
Channel Panels	MARS™ CLIMAPLUS™	100mm x 1200	FLB	<input type="checkbox"/> ME86568	SLT	<input type="checkbox"/> ME86540	SQ	<input type="checkbox"/> ME86514
	MARS™ CLIMAPLUS™ High-NRC	100mm x 1200	FLB	<input type="checkbox"/> ME86475	SLT	<input type="checkbox"/> ME86440	SQ	<input type="checkbox"/> ME86402
	PANZ® Metal Panels, Solid	100mm x 1200	FL	<input type="checkbox"/> ME909947				

Step 3. Select Corresponding Grid for Selected Panels











			Qty	Item No.	Qty	Item No.	Qty	Item No.
Suspension Systems	CENTRICITEE™ DXT™	Main Tee	1	<input type="checkbox"/> MEDXT24SP201			1	<input type="checkbox"/> MEDXT24SP201
		Cross Tee 1	2	<input type="checkbox"/> MEDXT1200			2	<input type="checkbox"/> MEDXT1200
		Cross Tee 2	1	<input type="checkbox"/> MEDXT1200			1	<input type="checkbox"/> MEDXT1200
		Cross Tee 3	2	<input type="checkbox"/> MEDXT550			2	<input type="checkbox"/> MEDXT550
	IDENTITEE™ DXI™	Main Tee	1	<input type="checkbox"/> MEDXI24SP201				
		Cross Tee 1	2	<input type="checkbox"/> MEDXI1200				
		Cross Tee 2	1	<input type="checkbox"/> MEDXI1200				
		Cross Tee 3	2	<input type="checkbox"/> MEDXI550				
	DONN® DX®	Main Tee			1	<input type="checkbox"/> MEDX24SP201	1	<input type="checkbox"/> MEDX24SP201
		Cross Tee 1			2	<input type="checkbox"/> MEDX1200	2	<input type="checkbox"/> MEDX1200
		Cross Tee 2			1	<input type="checkbox"/> MEDX1200	1	<input type="checkbox"/> MEDX1200
		Cross Tee 3			2	<input type="checkbox"/> MEDX550	2	<input type="checkbox"/> MEDX550

Suspension System Estimator

	Length	m ²	Main Tee Usage Per m ²	Cross Tee 1 Usage Per m ²	Cross Tee 2 Usage Per m ²	Cross Tee 3 Usage Per m ²
System Module	1200mm	1.440	0.833	1.667	0.833	0.764

Note: Multiply the ceiling area (SF) by the Usage Factor (UF). This calculation will determine lineal footage of suspension system components required. Please refer to page 11 for stabilizer bar usage.

Selector

Channel Width	Ceiling Module	On-Center Channel Spacing	Field Panels	Panel Edge	Suspension System
100mm	1200mm	1200mm	HALCYON™ CLIMAPLUS™ 1100mm x 600mm	FL 	DXT™, DXI™, DXF™
				SL 	DX®
				SQ 	DX®
			MARS™ CLIMAPLUS™ 1100mm x 600mm	FLB 	DXT™, DXI™, DXF™
				SLT 	DX®
				SQ 	DX®
			MARS™ CLIMAPLUS™ High-NRC 1100mm x 600mm	FLB 	DXT™, DXI™, DXF™
				SLT 	DX®
				SQ 	DX®
			PANZ® Metal Panels, Solid 1100mm x 600mm	FL 	DXT™, DXI™

Module Layout

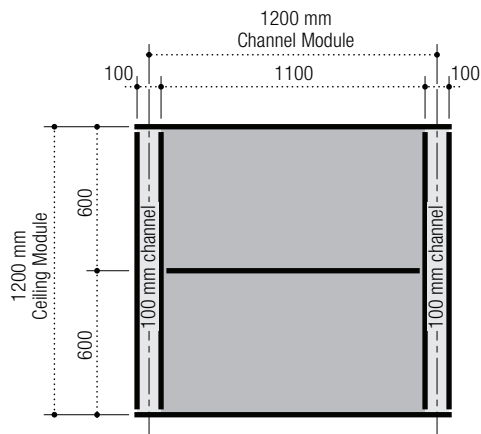

Panel Layout

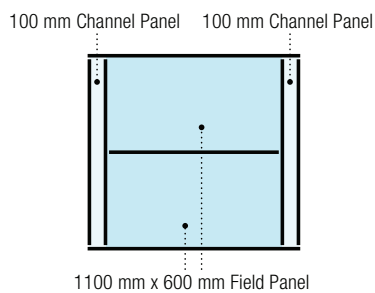

Suspension System Layout

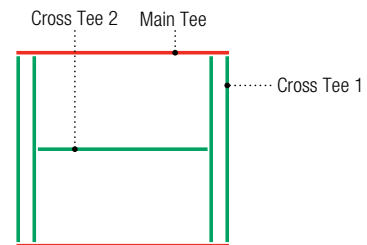



Step 1. Select Panels

Step 2. Select Edge for Panels

			FL/FLB		SL/SLT		SQ	
			Edge	Item No.	Edge	Item No.	Edge	Item No.
Field Panels	HALCYON™ CLIMAPLUS™	1100mm x 600mm	FL	<input type="checkbox"/> ME97470	SL	<input type="checkbox"/> ME97444	SQ	<input type="checkbox"/> ME97416
	MARS™ CLIMAPLUS™	1100mm x 600mm	FLB	<input type="checkbox"/> ME86578	SLT	<input type="checkbox"/> ME86556	SQ	<input type="checkbox"/> ME86528
	MARS™ CLIMAPLUS™ High-NRC	1100mm x 600mm	FLB	<input type="checkbox"/> ME86489	SLT	<input type="checkbox"/> ME86457	SQ	<input type="checkbox"/> ME86420
	PANZ® Metal Panels, Solid	1100mm x 600mm	FL	<input type="checkbox"/> ME909969				
Channel Panels	MARS™ CLIMAPLUS™	100mm x 1200mm	FLB	<input type="checkbox"/> ME86568	SLT	<input type="checkbox"/> ME86540	SQ	<input type="checkbox"/> ME86514
	MARS™ CLIMAPLUS™ High-NRC	100mm x 1200mm	FLB	<input type="checkbox"/> ME86475	SLT	<input type="checkbox"/> ME86440	SQ	<input type="checkbox"/> ME86402
	PANZ® Metal Panels, Solid	100mm x 1200mm	FL	<input type="checkbox"/> ME909947				

Step 3. Select Corresponding Grid for Selected Panels



			Qty	Item No.	Qty	Item No.	Qty	Item No.
Suspension Systems	CENTRICITEE™ DX™	Main Tee		<input type="checkbox"/> MEDXT24SP201				
		Cross Tee 1	2	<input type="checkbox"/> MEDXT1200				
		Cross Tee 2	1	<input type="checkbox"/> MEDXT1100				
	IDENTITEE™ DX™	Main Tee		<input type="checkbox"/> MEDXI24SP201				
		Cross Tee 1	2	<input type="checkbox"/> MEDXI1200				
		Cross Tee 2	1	<input type="checkbox"/> MEDXI1100				
	DONN® DX®	Main Tee			<input type="checkbox"/> MEDX24SP201		<input type="checkbox"/> MEDX24SP201	
		Cross Tee 1			2	<input type="checkbox"/> MEDX1200	2	<input type="checkbox"/> MEDX1200
		Cross Tee 2			1	<input type="checkbox"/> MEDX1100	1	<input type="checkbox"/> MEDX1100

Suspension System Estimator

	Length	m ²	Main Tee Usage Per m ²	Cross Tee 1 Usage Per m ²	Cross Tee 2 Usage Per m ²	
System Module	1200mm	1.440	0.833	1.667	0.764	

Note: Multiply the ceiling area (SF) by the Usage Factor (UF). This calculation will determine lineal footage of suspension system components required. Please refer to page 11 for stabilizer bar usage.

Selector

Channel Width	Ceiling Module	On-Center Channel Spacing	Field Panels	Panel Edge	Suspension System
100mm	1200mm	1200mm	HALCYON™ CLIMAPLUS™ 1100mm x 1200mm	FL  SL  SQ 	DXT™, DXI™, DXF™ DX® DX®

Module Layout

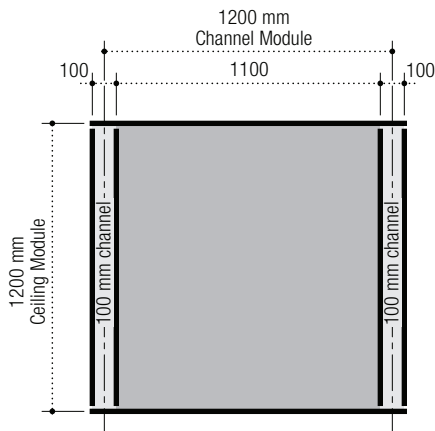

Panel Layout

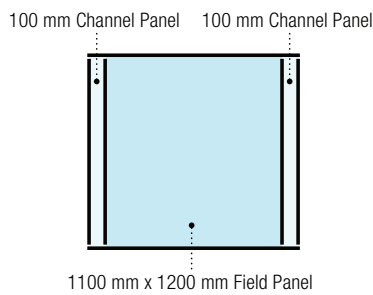

Suspension System Layout

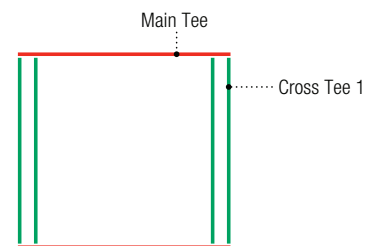

Order Information
System 105

1200mm Ceiling Module

100mm Channel

1100mm x 1200mm Field Panel



Step 1. Select Panels

Step 2. Select Edge for Panels

			FL/FLB		SL/SLT		SQ	
			Edge	Item No.	Edge	Item No.	Edge	Item No.
Field Panels	HALCYON™ CLIMAPLUS™	1100mm x 1200mm	FL	<input type="checkbox"/> ME97562	SL	<input type="checkbox"/> ME97533	SQ	<input type="checkbox"/> ME97505

Channel Panels	PANZ® Metal Panels, Solid	100mm x 1200mm	FL	<input type="checkbox"/> ME909947				
-----------------------	---------------------------	----------------	----	-----------------------------------	--	--	--	--

Step 3. Select Corresponding Grid for Selected Panels

			Qty	Item No.	Qty	Item No.	Qty	Item No.
Suspension Systems	CENTRICITEE™ DXT™	Main Tee		<input type="checkbox"/> MEDXT24SP201				
		Cross Tee 1	2	<input type="checkbox"/> MEDXT1200				
	IDENTITEE™ DXI™	Main Tee		<input type="checkbox"/> MEDXI24SP201				
		Cross Tee 1	2	<input type="checkbox"/> MEDXI1200				
	DONN® DX®	Main Tee			<input type="checkbox"/> MEDX24SP201		<input type="checkbox"/> MEDX24SP201	
		Cross Tee 1			2	<input type="checkbox"/> MEDX1200	2	<input type="checkbox"/> MEDX1200

Suspension System Estimator

	Length	m ²	Main Tee Usage Per m ²	Cross Tee 1 Usage Per m ²	
System Module	1200mm	1.440	0.833	1.667	











Note: Multiply the ceiling area (SF) by the Usage Factor (UF). This calculation will determine lineal footage of suspension system components required. Please refer to page 11 for stabilizer bar usage.

Metric Systems
System 112

1200mm Ceiling Module

100mm Channel
1200mm x 600mm Field Panel

Selector

Channel Width	Ceiling Module	On-Center Channel Spacing	Field Panels	Panel Edge	Suspension System
100mm	1200mm	1300mm	HALCYON™ CLIMAPLUS™ 1200mm x 600mm	FL 	DXT™, DXI™, DXF™
				SL 	DX®
				SQ 	DX®
			MARS™ CLIMAPLUS™ 1200mm x 600mm	FLB 	DXT™, DXI™, DXF™
				SLT 	DX®
				SQ 	DX®
			MARS™ CLIMAPLUS™ High-NRC 1200mm x 600mm	FLB 	DXT™, DXI™, DXF™
				SLT 	DX®
				SQ 	DX®
			PANZ® Metal Panels, Solid 1200mm x 600mm	FL 	DXT™, DXI™

Module Layout

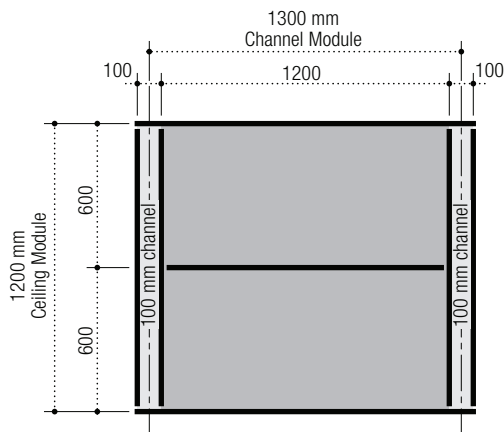

Panel Layout

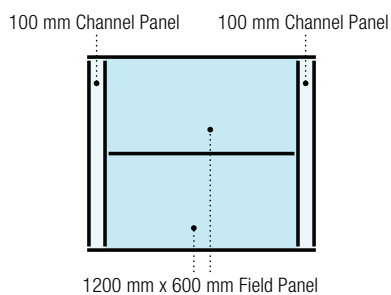

Suspension System Layout

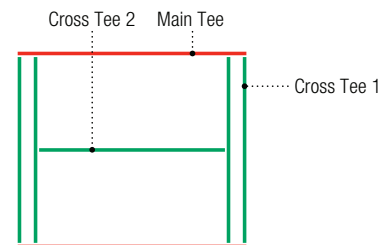



Step 1. Select Panels

Step 2. Select Edge for Panels

			FL/FLB		SL/SLT		SQ	
			Edge	Item No.	Edge	Item No.	Edge	Item No.
Field Panels	HALCYON™ CLIMAPLUS™	1200mm x 600mm	FL	<input type="checkbox"/> ME98245	SL	<input type="checkbox"/> ME98243	SQ	<input type="checkbox"/> ME98241
	MARS™ CLIMAPLUS™	1200mm x 600mm	FLB	<input type="checkbox"/> ME88985	SLT	<input type="checkbox"/> ME88785	SQ	<input type="checkbox"/> ME88185
	MARS™ CLIMAPLUS™ High-NRC	1200mm x 600mm	FLB	<input type="checkbox"/> ME89500	SLT	<input type="checkbox"/> ME89600	SQ	<input type="checkbox"/> ME86300
	PANZ® Metal Panels, Solid	1200mm x 600mm	FL	<input type="checkbox"/> ME909974				
Channel Panels	MARS™ CLIMAPLUS™	100mm x 1200mm	FLB	<input type="checkbox"/> ME86568	SLT	<input type="checkbox"/> ME86540	SQ	<input type="checkbox"/> ME86514
	MARS™ CLIMAPLUS™ High-NRC	100mm x 1200mm	FLB	<input type="checkbox"/> ME86475	SLT	<input type="checkbox"/> ME86440	SQ	<input type="checkbox"/> ME86402
	PANZ® Metal Panels, Solid	100mm x 1200mm	FL	<input type="checkbox"/> ME909947				

Step 3. Select Corresponding Grid for Selected Panels



			Qty	Item No.	Qty	Item No.	Qty	Item No.
Suspension Systems	CENTRICITEE™ DX™	Main Tee		<input type="checkbox"/> MEDXT24SP203				
		Cross Tee 1	2	<input type="checkbox"/> MEDXT1200				
		Cross Tee 2	1	<input type="checkbox"/> MEDXT1200				
	IDENTITEE™ DX™	Main Tee		<input type="checkbox"/> MEDXI24SP203				
		Cross Tee 1	2	<input type="checkbox"/> MEDXI1200				
		Cross Tee 2	1	<input type="checkbox"/> MEDXI1200				
	DONN® DX®	Main Tee			<input type="checkbox"/> MEDX24SP203		<input type="checkbox"/> MEDX24SP203	
		Cross Tee 1			2	<input type="checkbox"/> MEDX1200	2	<input type="checkbox"/> MEDX1200
		Cross Tee 2			1	<input type="checkbox"/> MEDX1200	1	<input type="checkbox"/> MEDX1200

Suspension System Estimator

	Length	m ²	Main Tee Usage Per m ²	Cross Tee 1 Usage Per m ²	Cross Tee 2 Usage Per m ²	
System Module	1300mm	1.560	0.833	1.538	0.769	

Note: Multiply the ceiling area (SF) by the Usage Factor (UF). This calculation will determine lineal footage of suspension system components required. Please refer to page 11 for stabilizer bar usage.

Selector

Channel Width	Ceiling Module	On-Center Channel Spacing	Field Panels	Panel Edge	Suspension System
100mm	1200mm	1300mm	HALCYON™ CLIMAPLUS™ 1200mm x 1200mm	FL  SL  SQ 	DXT™, DXI™, DXF™ DX® DX®

Module Layout

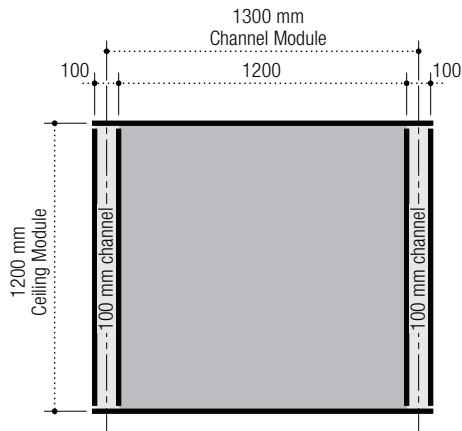

Panel Layout

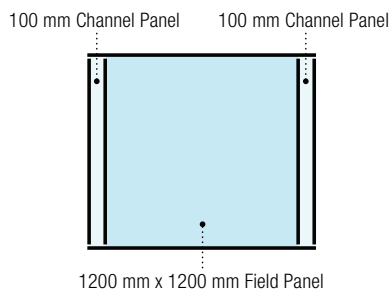

Suspension System Layout

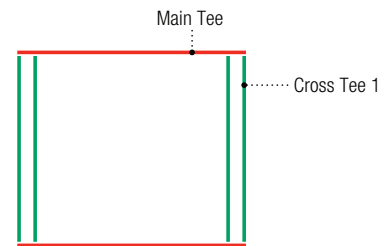

Order Information
System 108

1200mm Ceiling Module

100mm Channel

1200mm x 1200mm Field Panel



Step 1. Select Panels

Step 2. Select Edge for Panels

			FL/FLB		SL/SLT		SQ	
			Edge	Item No.	Edge	Item No.	Edge	Item No.
Field Panels	HALCYON™ CLIMAPLUS™	1200mm x 1200mm	FL	<input type="checkbox"/> ME98445	SL	<input type="checkbox"/> ME98443	SQ	<input type="checkbox"/> ME98441

Channel Panels	PANZ® Metal Panels, Solid	100mm x 1200mm	FL	<input type="checkbox"/> ME909947				
-----------------------	---------------------------	----------------	----	-----------------------------------	--	--	--	--

Step 3. Select Corresponding Grid for Selected Panels

			Qty	Item No.	Qty	Item No.	Qty	Item No.
Suspension Systems	CENTRICITEE™ DXT™	Main Tee		<input type="checkbox"/> MEDXT24SP203				
		Cross Tee 1	2	<input type="checkbox"/> MEDXT1200				
	IDENTITEE™ DXI™	Main Tee		<input type="checkbox"/> MEDXI24SP203				
		Cross Tee 1	2	<input type="checkbox"/> MEDXI1200				
	DONN® DX®	Main Tee			<input type="checkbox"/> MEDX24SP203		<input type="checkbox"/> MEDX24SP203	
		Cross Tee 1			2	<input type="checkbox"/> MEDX1200	2	<input type="checkbox"/> MEDX1200

Suspension System Estimator

	Length	m ²	Main Tee Usage Per m ²	Cross Tee 1 Usage Per m ²	
System Module	1300mm	1.560	0.833	1.538	

Note: Multiply the ceiling area (SF) by the Usage Factor (UF). This calculation will determine lineal footage of suspension system components required. Please refer to page 11 for stabilizer bar usage.

Metric Systems











System 141

1200mm Ceiling Module

100mm Channel

1800mm x 300mm Field Panel

Selector

Channel Width	Ceiling Module	On-Center Channel Spacing	Field Panels	Panel Edge	Suspension System
100mm	1200mm	1900mm	HALCYON™ CLIMAPLUS™ 1800mm x 300mm	FL 	DXT™, DXI™, DXF™
				SL 	DX®
				SQ 	DX®
			MARS™ CLIMAPLUS™ 1800mm x 300mm	FLB 	DXT™, DXI™, DXF™
				SLT 	DX®
				SQ 	DX®
			MARS™ CLIMAPLUS™ High-NRC 1800mm x 300mm	FLB 	DXT™, DXI™, DXF™
				SLT 	DX®
				SQ 	DX®
			PANZ® Metal Panels, Solid 1800mm x 300mm	FL 	DXT™, DXI™

Module Layout

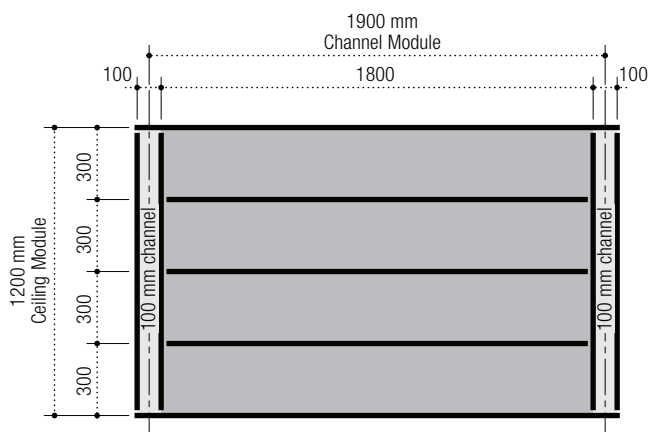

Panel Layout

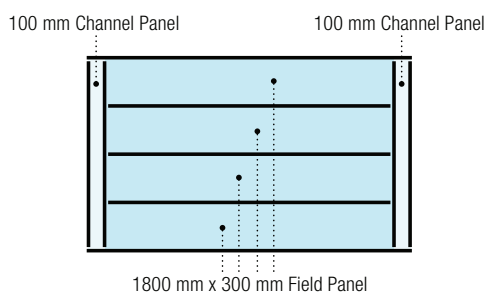

Suspension System Layout

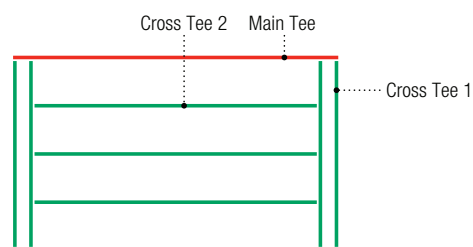

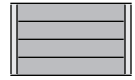

Step 1. Select Panels

Step 2. Select Edge for Panels

			FL/FLB		SL/SLT		SQ	
			Edge	Item No.	Edge	Item No.	Edge	Item No.
Field Panels	HALCYON™ CLIMAPLUS™	300mm x 1800mm	FL	<input type="checkbox"/> ME97574	SL	<input type="checkbox"/> ME97433	SQ	<input type="checkbox"/> ME97405
	MARS™ CLIMAPLUS™	300mm x 1800mm	FLB	<input type="checkbox"/> ME86570	SLT	<input type="checkbox"/> ME86546	SQ	<input type="checkbox"/> ME86518
	MARS™ CLIMAPLUS™ High-NRC	300mm x 1800mm	FLB	<input type="checkbox"/> ME86478	SLT	<input type="checkbox"/> ME86446	SQ	<input type="checkbox"/> ME86409
	PANZ® Metal Panels, Solid	300mm x 1800mm	FL	<input type="checkbox"/> ME909956				
Channel Panels	MARS™ CLIMAPLUS™	100mm x 1200mm	FLB	<input type="checkbox"/> ME86568	SLT	<input type="checkbox"/> ME86540	SQ	<input type="checkbox"/> ME86514
	MARS™ CLIMAPLUS™ High-NRC	100mm x 1200mm	FLB	<input type="checkbox"/> ME86475	SLT	<input type="checkbox"/> ME86440	SQ	<input type="checkbox"/> ME86402
	PANZ® Metal Panels, Solid	100mm x 1200mm	FL	<input type="checkbox"/> ME909947				

Step 3. Select Corresponding Grid for Selected Panels

			Qty	Item No.	Qty	Item No.	Qty	Item No.
Suspension Systems	CENTRICITEE™ DXT™ (Use with PANZ®)	Main Tee		<input type="checkbox"/> MEDXT24SP203				
		Cross Tee 1	2	<input type="checkbox"/> MEDXT1200				
		Cross Tee 2	3	<input type="checkbox"/> MEDXT1900				
	IDENTITEE™ DXI™	Main Tee		<input type="checkbox"/> MEDXI24SP203				
		Cross Tee 1	2	<input type="checkbox"/> MEDXI1200				
		Cross Tee 2	3	<input type="checkbox"/> MEDXI1900				
	DONN® DX®	Main Tee			<input type="checkbox"/> MEDX24SP203		<input type="checkbox"/> MEDX24SP203	
		Cross Tee 1			2	<input type="checkbox"/> MEDX1200	2	<input type="checkbox"/> MEDX1200
		Cross Tee 2			3	<input type="checkbox"/> MEDX1900	3	<input type="checkbox"/> MEDX1900

Suspension System Estimator

	Length	m ²	Main Tee Usage Per m ²	Cross Tee 1 Usage Per m ²	Cross Tee 2 Usage Per m ²	
System Module	1900mm	2.280	0.833	1.053	2.500	

Note: Multiply the ceiling area (SF) by the Usage Factor (UF). This calculation will determine lineal footage of suspension system components required. Please refer to page 11 for stabilizer bar usage.

Metric Systems









System 139

1200mm Ceiling Module

100mm Channel

1800mm x 600mm Field Panel

Selector

Channel Width	Ceiling Module	On-Center Channel Spacing	Field Panels	Panel Edge	Suspension System
100mm	1200mm	1900mm	HALCYON™ CLIMAPLUS™ 1800mm x 600mm	FL 	DXT™, DXI™, DXF™
				SL 	DX®
				SQ 	DX®
			MARS™ CLIMAPLUS™ 1800mm x 600mm	FLB 	DXT™, DXI™, DXF™
				SLT 	DX®
				SQ 	DX®
			MARS™ CLIMAPLUS™ High-NRC 1800mm x 600mm	FLB 	DXT™, DXI™, DXF™
				SLT 	DX®
				SQ 	DX®

Module Layout

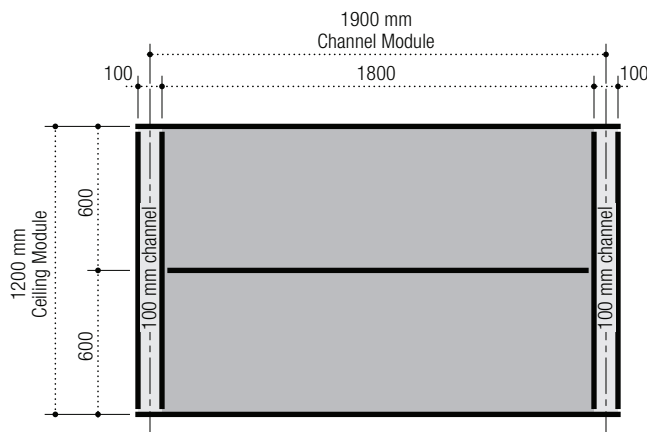

Panel Layout

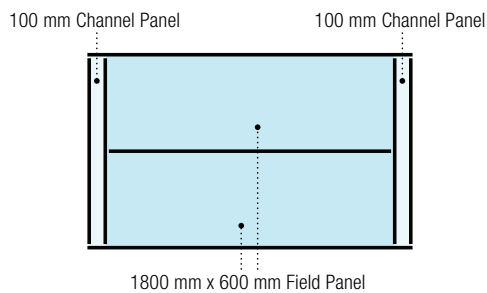

Suspension System Layout

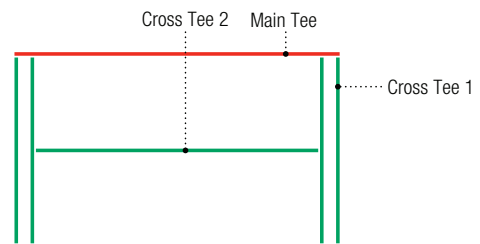



Step 1. Select Panels

Step 2. Select Edge for Panels

			FL/FLB		SL/SLT		SQ	
			Edge	Item No.	Edge	Item No.	Edge	Item No.
Field Panels	HALCYON™ CLIMAPLUS™	600mm x 1800mm	FL	<input type="checkbox"/> ME97553	SL	<input type="checkbox"/> ME97445	SQ	<input type="checkbox"/> ME99234
	MARS™ CLIMAPLUS™	600mm x 1800mm	FLB	<input type="checkbox"/> ME88996	SLT	<input type="checkbox"/> ME86166	SQ	<input type="checkbox"/> ME86223
	MARS™ CLIMAPLUS™ High-NRC	600mm x 1800mm	FLB	<input type="checkbox"/> ME89670	SLT	<input type="checkbox"/> ME89660	SQ	<input type="checkbox"/> ME86360
	PANZ® Metal Panels, Solid	300mm x 1800mm	FL	<input type="checkbox"/> ME909956				
Channel Panels	MARS™ CLIMAPLUS™	100mm x 1200mm	FLB	<input type="checkbox"/> ME86568	SLT	<input type="checkbox"/> ME86540	SQ	<input type="checkbox"/> ME86514
	MARS™ CLIMAPLUS™ High-NRC	100mm x 1200mm	FLB	<input type="checkbox"/> ME86475	SLT	<input type="checkbox"/> ME86440	SQ	<input type="checkbox"/> ME86402
	PANZ® Metal Panels, Solid	100mm x 1200mm	FL	<input type="checkbox"/> ME909947				

Step 3. Select Corresponding Grid for Selected Panels

			Qty	Item No.	Qty	Item No.	Qty	Item No.
Suspension Systems	CENTRICITEE™ DXT™	Main Tee		<input type="checkbox"/> MEDXT24SP203				
		Cross Tee 1	2	<input type="checkbox"/> MEDXT1200				
		Cross Tee 2	1	<input type="checkbox"/> MEDXT1900				
	IDENTITEE™ DXI™	Main Tee		<input type="checkbox"/> MEDXI24SP203				
		Cross Tee 1	2	<input type="checkbox"/> MEDXI1200				
		Cross Tee 2	1	<input type="checkbox"/> MEDXI1900				
	DONN® DX®	Main Tee			<input type="checkbox"/> MEDX24SP203		<input type="checkbox"/> MEDX24SP203	
		Cross Tee 1			2	<input type="checkbox"/> MEDX1200	2	<input type="checkbox"/> MEDX1200
		Cross Tee 2			1	<input type="checkbox"/> MEDX1900	1	<input type="checkbox"/> MEDX1900

Suspension System Estimator

	Length	m ²	Main Tee Usage Per m ²	Cross Tee 1 Usage Per m ²	Cross Tee 2 Usage Per m ²	
System Module	1900mm	2.280	0.833	1.053	0.833	

Note: Multiply the ceiling area (SF) by the Usage Factor (UF). This calculation will determine lineal footage of suspension system components required. Please refer to page 11 for stabilizer bar usage.

Metric Systems









1500mm Ceiling Module

100mm Channel

System 124

700mm x 750mm Field Panel

Selector

Channel Width	Ceiling Module	On-Center Channel Spacing	Field Panels	Panel Edge	Suspension System
100mm	1500mm	1500mm	HALCYON™ CLIMAPLUS™ 700mm x 750mm	FL 	DXT™, DXI™, DXF™
				SL 	DX®
				SQ 	DX®
			MARS™ CLIMAPLUS™ 700mm x 750mm	FLB 	DXT™, DXI™, DXF™
				SLT 	DX®
				SQ 	DX®
			MARS™ CLIMAPLUS™ High-NRC 700mm x 750mm	FLB 	DXT™, DXI™, DXF™
				SLT 	DX®
				SQ 	DX®

Module Layout

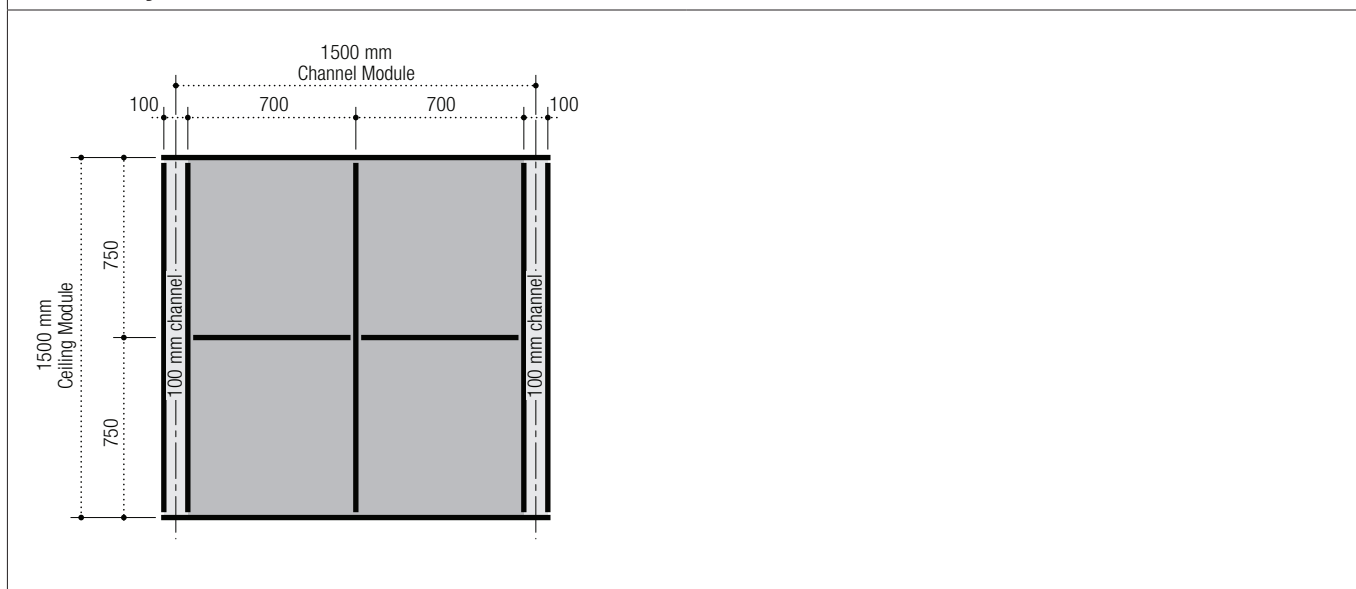

Panel Layout

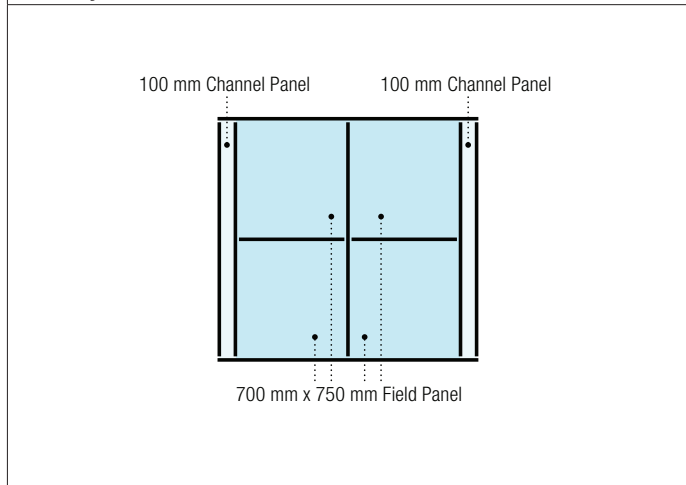

Suspension System Layout

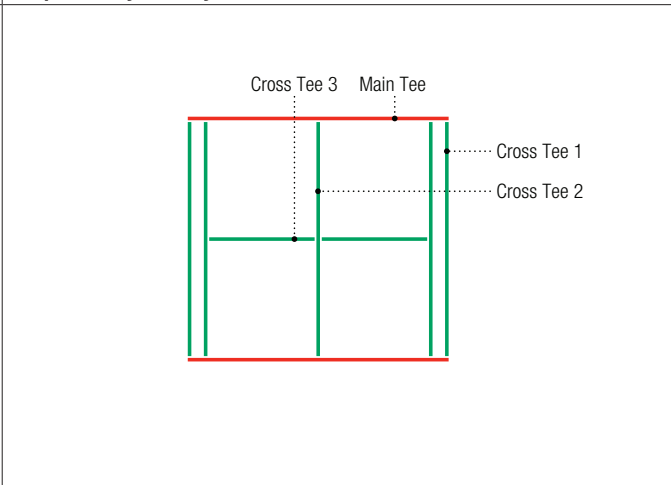

Order Information
System 124

1500mm Ceiling Module

100mm Channel

700mm x 750mm Field Panel

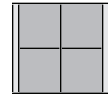

Step 1. Select Panels

Step 2. Select Edge for Panels

			FL/FLB		SL/SLT		SQ	
			Edge	Item No.	Edge	Item No.	Edge	Item No.
Field Panels	HALCYON™ CLIMAPLUS™	700mm x 750mm	FL	<input type="checkbox"/> ME97335	SL	<input type="checkbox"/> ME97449	SQ	<input type="checkbox"/> ME97419
	MARS™ CLIMAPLUS™	700mm x 750mm	FLB	<input type="checkbox"/> ME86834	SLT	<input type="checkbox"/> ME86559	SQ	<input type="checkbox"/> ME86532
	MARS™ CLIMAPLUS™ High-NRC	700mm x 750mm	FLB	<input type="checkbox"/> ME86492	SLT	<input type="checkbox"/> ME86459	SQ	<input type="checkbox"/> ME86423
	PANZ® Metal Panels, Solid	700mm x 750mm	FL	<input type="checkbox"/> ME909971				
Channel Panels	MARS™ CLIMAPLUS™	100mm x 1500mm	FLB	<input type="checkbox"/> ME86569	SLT	<input type="checkbox"/> ME86541	SQ	<input type="checkbox"/> ME86515
	MARS™ CLIMAPLUS™ High-NRC	100mm x 1500mm	FLB	<input type="checkbox"/> ME86476	SLT	<input type="checkbox"/> ME86441	SQ	<input type="checkbox"/> ME86403
	PANZ® Metal Panels, Solid	100mm x 1500mm	FL	<input type="checkbox"/> ME909949				

Step 3. Select Corresponding Grid for Selected Panels

			Qty	Item No.	Qty	Item No.	Qty	Item No.
Suspension Systems	CENTRICITEE™ DXT™ (Use with PANZ®)	Main Tee		<input type="checkbox"/> MEDXT24SP205				
		Cross Tee 1	2	<input type="checkbox"/> MEDXT1500				
		Cross Tee 2	2	<input type="checkbox"/> MEDXT1400				
	IDENTITEE™ DXI™	Main Tee		<input type="checkbox"/> MEDXI24SP205				
		Cross Tee 1	2	<input type="checkbox"/> MEDXI1500				
		Cross Tee 2	2	<input type="checkbox"/> MEDXI1400				
	DONN® DX®	Main Tee			<input type="checkbox"/> MEDX24SP205		<input type="checkbox"/> MEDX24SP205	
		Cross Tee 1			2	<input type="checkbox"/> MEDX1500	2	<input type="checkbox"/> MEDX1500
		Cross Tee 2			2	<input type="checkbox"/> MEDX1400	2	<input type="checkbox"/> MEDX1400

Suspension System Estimator

	Length	m ²	Main Tee Usage Per m ²	Cross Tee 1 Usage Per m ²	Cross Tee 2 Usage Per m ²	
System Module	1500mm	2.250	0.667	1.333	1.244	

Note: Multiply the ceiling area (SF) by the Usage Factor (UF). This calculation will determine lineal footage of suspension system components required. Please refer to page 11 for stabilizer bar usage.

Metric Systems











1500mm Ceiling Module

100mm Channel

System 110

1400mm x 750mm Field Panel

Selector

Channel Width	Ceiling Module	On-Center Channel Spacing	Field Panels	Panel Edge	Suspension System
100mm	1500mm	1500mm	HALCYON™ CLIMAPLUS™ 1400mm x 750mm	FL 	DXT™, DXI™, DXF™
				SL 	DX®
				SQ 	DX®
			MARS™ CLIMAPLUS™ 1400mm x 750mm	FLB 	DXT™, DXI™, DXF™
				SLT 	DX®
				SQ 	DX®
			MARS™ CLIMAPLUS™ High-NRC 1400mm x 750mm	FLB 	DXT™, DXI™, DXF™
				SLT 	DX®
				SQ 	DX®
PANZ® Metal Panels, Solid 1400mm x 750mm	FL 	DXT™, DXI™			

Module Layout

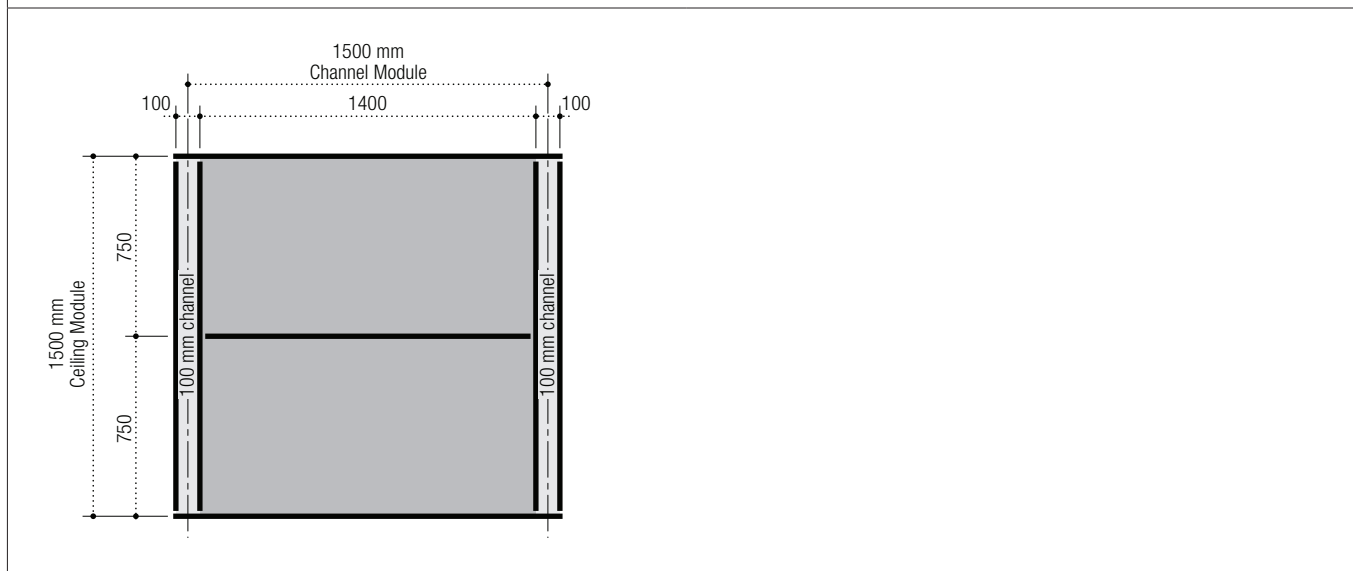

Panel Layout

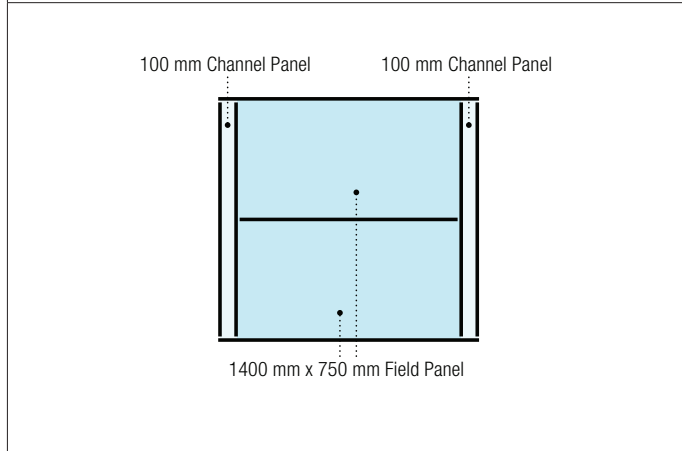

Suspension System Layout

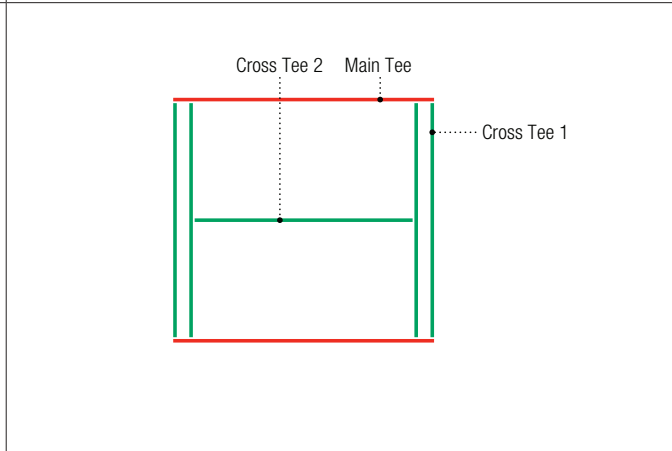

Order Information
System 110

1500mm Ceiling Module

100mm Channel

1400mm x 750mm Field Panel



Step 1. Select Panels

Step 2. Select Edge for Panels

			FL/FLB		SL/SLT		SQ	
			Edge	Item No.	Edge	Item No.	Edge	Item No.
Field Panels	HALCYON™ CLIMAPLUS™	1400mm x 750mm	FL	<input type="checkbox"/> ME97473	SL	<input type="checkbox"/> ME98453	SQ	<input type="checkbox"/> ME97423
	MARS™ CLIMAPLUS™	1400mm x 750mm	FLB	<input type="checkbox"/> ME86583	SLT	<input type="checkbox"/> ME86563	SQ	<input type="checkbox"/> ME86535
	MARS™ CLIMAPLUS™ High-NRC	1400mm x 750mm	FLB	<input type="checkbox"/> ME86496	SLT	<input type="checkbox"/> ME86465	SQ	<input type="checkbox"/> ME86428
	PANZ® Metal Panels, Solid	1400mm x 750mm	FL	<input type="checkbox"/> ME909973				
Channel Panels	MARS™ CLIMAPLUS™	100mm x 1500mm	FLB	<input type="checkbox"/> ME86569	SLT	<input type="checkbox"/> ME86541	SQ	<input type="checkbox"/> ME86515
	MARS™ CLIMAPLUS™ High-NRC	100mm x 1500mm	FLB	<input type="checkbox"/> ME86476	SLT	<input type="checkbox"/> ME86441	SQ	<input type="checkbox"/> ME86403
	PANZ® Metal Panels, Solid	100mm x 1500mm	FL	<input type="checkbox"/> ME99949				

Step 3. Select Corresponding Grid for Selected Panels











			Qty	Item No.	Qty	Item No.	Qty	Item No.
Suspension Systems	CENTRICITEE™ DXT™	Main Tee		<input type="checkbox"/> DXT24SP205				
		Cross Tee 1	2	<input type="checkbox"/> DXT1500				
		Cross Tee 2	1	<input type="checkbox"/> DXT1500				
		Cross Tee 3	2	<input type="checkbox"/> DXT700				
	IDENTITEE™ DXI™	Main Tee		<input type="checkbox"/> DXI24SP205				
		Cross Tee 1	2	<input type="checkbox"/> DXI1500				
		Cross Tee 2	1	<input type="checkbox"/> DXI1500				
		Cross Tee 3	2	<input type="checkbox"/> DXI700				
	DONN® DX®	Main Tee			<input type="checkbox"/> DX24SP205		<input type="checkbox"/> DX24SP205	
		Cross Tee 1			2	<input type="checkbox"/> DX1500	2	<input type="checkbox"/> DX1500
		Cross Tee 2			1	<input type="checkbox"/> DX1500	1	<input type="checkbox"/> DX1500
		Cross Tee 3			2	<input type="checkbox"/> DX700	2	<input type="checkbox"/> DX700

Suspension System Estimator

	Length	m ²	Main Tee Usage Per m ²	Cross Tee 1 Usage Per m ²	Cross Tee 2 Usage Per m ²	Cross Tee 3 Usage Per m ²
System Module	1500mm	2.250	0.667	1.333	0.667	0.622

Note: Multiply the ceiling area (SF) by the Usage Factor (UF). This calculation will determine lineal footage of suspension system components required. Please refer to page 11 for stabilizer bar usage.

Selector

Channel Width	Ceiling Module	On-Center Channel Spacing	Field Panels	Panel Edge	Suspension System
100mm	1500mm	1500mm	HALCYON™ CLIMAPLUS™ 1400mm x 500mm	FL 	DXT™, DXI™, DXF™
				SL 	DX®
				SQ 	DX®
			MARS™ CLIMAPLUS™ 1400mm x 500mm	FLB 	DXT™, DXI™, DXF™
				SLT 	DX®
				SQ 	DX®
			MARS™ CLIMAPLUS™ High-NRC 1400mm x 500mm	FLB 	DXT™, DXI™, DXF™
				SLT 	DX®
				SQ 	DX®
			PANZ® Metal Panels, Solid 1400mm x 500mm	FL 	DXT™, DXI™

Module Layout

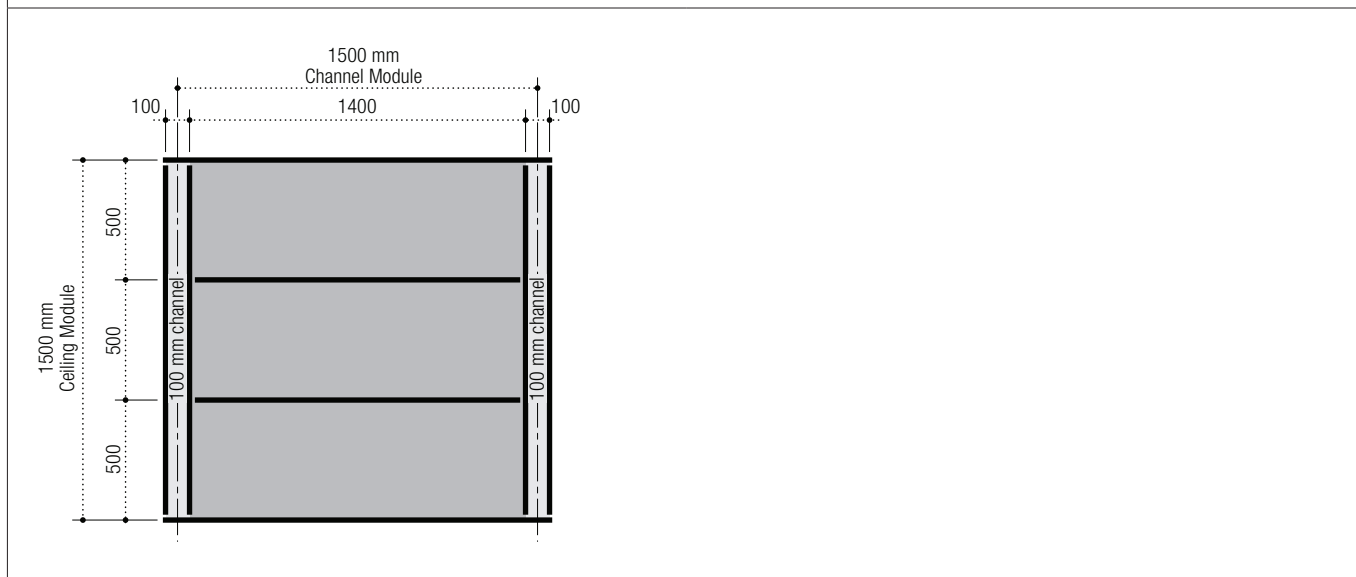

Panel Layout

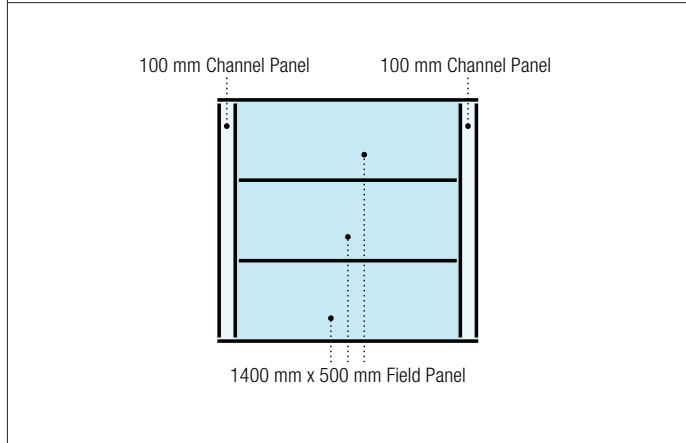

Suspension System Layout

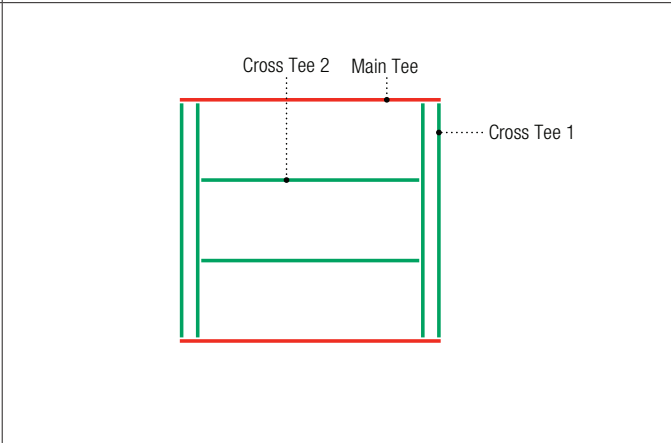

Order Information
System 102

1500mm Ceiling Module

100mm Channel

1400mm x 500mm Field Panel

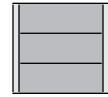

Step 1. Select Panels

Step 2. Select Edge for Panels

			FL/FLB		SL/SLT		SQ	
			Edge	Item No.	Edge	Item No.	Edge	Item No.
Field Panels	HALCYON™ CLIMAPLUS™	1400mm x 500mm	FL	<input type="checkbox"/> ME97464	SL	<input type="checkbox"/> ME97437	SQ	<input type="checkbox"/> ME97408
	MARS™ CLIMAPLUS™	1400mm x 500mm	FLB	<input type="checkbox"/> ME86571	SLT	<input type="checkbox"/> ME86548	SQ	<input type="checkbox"/> ME86520
	MARS™ CLIMAPLUS™ High-NRC	1400mm x 500mm	FLB	<input type="checkbox"/> ME86480	SLT	<input type="checkbox"/> ME86448	SQ	<input type="checkbox"/> ME86411
	PANZ® Metal Panels, Solid	300mm x 1800mm	FL	<input type="checkbox"/> ME909956				
Channel Panels	MARS™ CLIMAPLUS™	100mm x 1500mm	FLB	<input type="checkbox"/> ME86569	SLT	<input type="checkbox"/> ME86541	SQ	<input type="checkbox"/> ME86515
	MARS™ CLIMAPLUS™ High-NRC	100mm x 1500mm	FLB	<input type="checkbox"/> ME86476	SLT	<input type="checkbox"/> ME86441	SQ	<input type="checkbox"/> ME86403
	PANZ® Metal Panels, Solid	100mm x 1500mm	FL	<input type="checkbox"/> ME909949				

Step 3. Select Corresponding Grid for Selected Panels

			Qty	Item No.	Qty	Item No.	Qty	Item No.
Suspension Systems	CENTRICITEE™ DXT™	Main Tee		<input type="checkbox"/> MEDXT24SP205				
		Cross Tee 1	2	<input type="checkbox"/> MEDXT1000				
	IDENTITEE™ DXI™	Main Tee		<input type="checkbox"/> MEDXI24SP205				
		Cross Tee 1	2	<input type="checkbox"/> MEDXI1000				
	DONN® DX®	Main Tee			<input type="checkbox"/> MEDX24SP205		<input type="checkbox"/> MEDX24SP205	
		Cross Tee 1			2	<input type="checkbox"/> MEDX1000	2	<input type="checkbox"/> MEDX1000

Suspension System Estimator

	Length	m ²	Main Tee Usage Per m ²	Cross Tee 1 Usage Per m ²	
System Module	1500mm	1.500	1.000	1.333	



Note: Multiply the ceiling area (SF) by the Usage Factor (UF). This calculation will determine lineal footage of suspension system components required. Please refer to page 11 for stabilizer bar usage.

Metric Systems
System 129

1500mm Ceiling Module

100mm Channel
1400mm x 1500mm Field Panel

Selector

Channel Width	Ceiling Module	On-Center Channel Spacing	Field Panels	Panel Edge	Suspension System
100mm	1500mm	1500mm	HALCYON™ CLIMAPLUS™ 1400mm x 1500mm	FL 	DXT™, DXI™, DXF™
				SL 	DX®
				SQ 	DX®

Module Layout

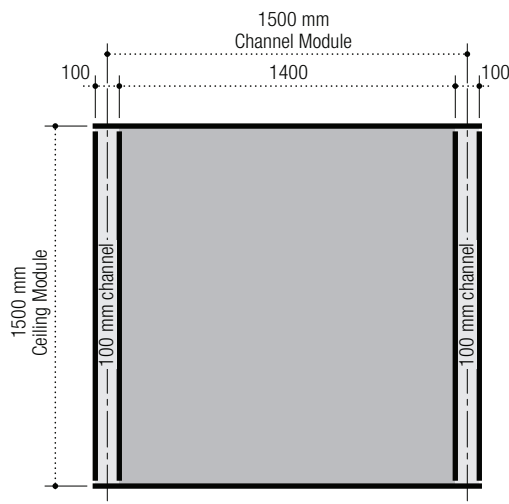

Panel Layout

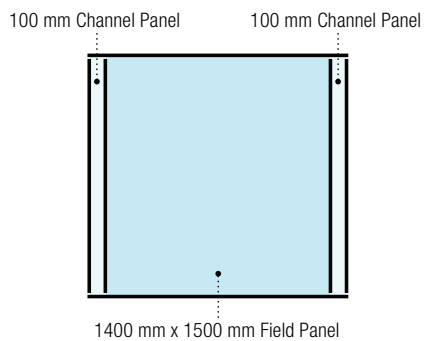

Suspension System Layout

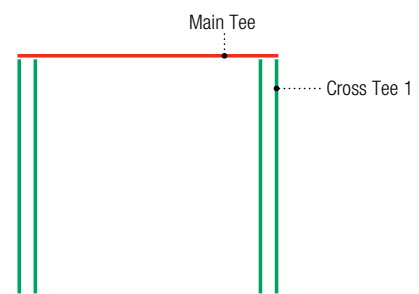

Order Information
System 129

1500mm Ceiling Module

100mm Channel
1400mm x 1500mm Field Panel

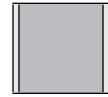

Step 1. Select Panels

Step 2. Select Edge for Panels

			FL/FLB		SL/SLT		SQ	
			Edge	Item No.	Edge	Item No.	Edge	Item No.
Field Panels	HALCYON™ CLIMAPLUS™	1400mm x 1500mm	FL	<input type="checkbox"/> ME99229	SL	<input type="checkbox"/> ME97537	SQ	<input type="checkbox"/> ME97567

Channel Panels	PANZ® Metal Panels, Solid	100mm x 1500mm	FL	<input type="checkbox"/> ME909949				
-----------------------	---------------------------	----------------	----	-----------------------------------	--	--	--	--

Step 3. Select Corresponding Grid for Selected Panels









			Qty	Item No.	Qty	Item No.	Qty	Item No.
Suspension Systems	CENTRICITEE™ DXT™	Main Tee		<input type="checkbox"/> MEDXT24SP205				
		Cross Tee 1	2	<input type="checkbox"/> MEDXT1500				
		Cross Tee 2	1	<input type="checkbox"/> MEDXT1400				
	IDENTITEE™ DXI™	Main Tee		<input type="checkbox"/> MEDXI24SP205				
		Cross Tee 1	2	<input type="checkbox"/> MEDXI1500				
		Cross Tee 2	1	<input type="checkbox"/> MEDXI1400				
	DONN® DX®	Main Tee			<input type="checkbox"/> MEDX24SP205		<input type="checkbox"/> MEDX24SP205	
		Cross Tee 1			2	<input type="checkbox"/> MEDX1500	2	<input type="checkbox"/> MEDX1500
		Cross Tee 2			1	<input type="checkbox"/> MEDX1400	1	<input type="checkbox"/> MEDX1400

Suspension System Estimator

	Length	m ²	Main Tee Usage Per m ²	Cross Tee 1 Usage Per m ²	Cross Tee 2 Usage Per m ²	
System Module	1500mm	2.250	0.667	1.333	0.622	

Note: Multiply the ceiling area (SF) by the Usage Factor (UF). This calculation will determine lineal footage of suspension system components required. Please refer to page 11 for stabilizer bar usage.

Selector

Channel Width	Ceiling Module	On-Center Channel Spacing	Field Panels	Panel Edge	Suspension System
150mm	1000mm	1500mm	HALCYON™ CLIMAPLUS™ 675mm x 500mm	FL 	DXT™, DXI™, DXF™
				SL 	DX®
				SQ 	DX®
			MARS™ CLIMAPLUS™ 675mm x 500mm	FLB 	DXT™, DXI™, DXF™
				SLT 	DX®
				SQ 	DX®
			MARS™ CLIMAPLUS™ High-NRC 675mm x 500mm	FLB 	DXT™, DXI™, DXF™
				SLT 	DX®
				SQ 	DX®

Module Layout

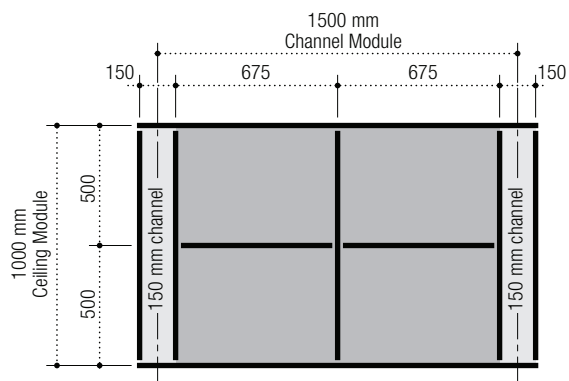

Panel Layout

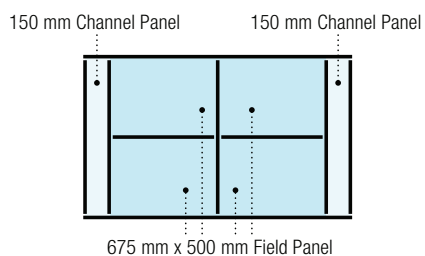

Suspension System Layout

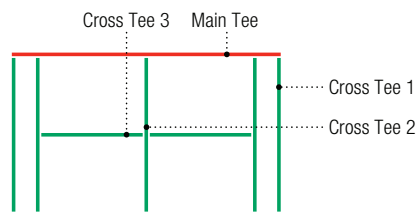

Order Information
System 136

1000mm Ceiling Module

150mm Channel
675mm x 500mm Field Panel



Step 1. Select Panels

Step 2. Select Edge for Panels

			FL/FLB		SL/SLT		SQ	
			Edge	Item No.	Edge	Item No.	Edge	Item No.
Field Panels	HALCYON™ CLIMAPLUS™	675mm x 500mm	FL	<input type="checkbox"/> ME97544	SL	<input type="checkbox"/> ME97515	SQ	<input type="checkbox"/> ME97486
	MARS™ CLIMAPLUS™	675mm x 500mm	FLB	<input type="checkbox"/> ME86648	SLT	<input type="checkbox"/> ME86625	SQ	<input type="checkbox"/> ME86599
	MARS™ CLIMAPLUS™ High-NRC	675mm x 500mm	FLB	<input type="checkbox"/> ME86069	SLT	<input type="checkbox"/> ME86044	SQ	<input type="checkbox"/> ME86015
	PANZ® Metal Panels, Solid	675mm x 500mm	FL	<input type="checkbox"/> ME909960				
Channel Panels	HALCYON™ CLIMAPLUS™	150mm x 1000mm	FL	<input type="checkbox"/> ME98198	SL	<input type="checkbox"/> ME99271	SQ	<input type="checkbox"/> ME97227
	PANZ® Metal Panels, Solid	150mm x 1000mm	FL	<input type="checkbox"/> ME909953				

Step 3. Select Corresponding Grid for Selected Panels









			Qty	Item No.	Qty	Item No.	Qty	Item No.
Suspension Systems	CENTRICITEE™ DXT™	Main Tee		<input type="checkbox"/> MEDXT24SP206				
		Cross Tee 1	2	<input type="checkbox"/> MEDXT1000				
		Cross Tee 2	1	<input type="checkbox"/> MEDXT1000				
		Cross Tee 3	2	<input type="checkbox"/> MEDXT675				
	IDENTITEE™ DXI™	Main Tee		<input type="checkbox"/> MEDXI24SP206				
		Cross Tee 1	2	<input type="checkbox"/> MEDXI1000				
		Cross Tee 2	1	<input type="checkbox"/> MEDXI1000				
		Cross Tee 3	2	<input type="checkbox"/> MEDXI675				
	DONN® DX®	Main Tee			<input type="checkbox"/> MEDX24SP206		<input type="checkbox"/> MEDX24SP206	
		Cross Tee 1			2	<input type="checkbox"/> MEDX1000	2	<input type="checkbox"/> MEDX1000
		Cross Tee 2			1	<input type="checkbox"/> MEDX1000	1	<input type="checkbox"/> MEDX1000
		Cross Tee 3			2	<input type="checkbox"/> MEDXI675	2	<input type="checkbox"/> MEDXI675

Suspension System Estimator

	Length	m ²	Main Tee Usage Per m ²	Cross Tee 1 Usage Per m ²	Cross Tee 2 Usage Per m ²	Cross Tee 3 Usage Per m ²
System Module	1500mm	1.500	1.000	1.333	0.667	0.900

Note: Multiply the ceiling area (SF) by the Usage Factor (UF). This calculation will determine lineal footage of suspension system components required. Please refer to page 11 for stabilizer bar usage.

Selector

Channel Width	Ceiling Module	On-Center Channel Spacing	Field Panels	Panel Edge	Suspension System
150mm	1000mm	1500mm	HALCYON™ CLIMAPLUS™ 1350mm x 500mm	FL 	DXT™, DXI™, DXF™
				SL 	DX®
				SQ 	DX®
			MARS™ CLIMAPLUS™ 1350mm x 500mm	FLB 	DXT™, DXI™, DXF™
				SLT 	DX®
				SQ 	DX®
			MARS™ CLIMAPLUS™ High-NRC 1350mm x 500mm	FLB 	DXT™, DXI™, DXF™
				SLT 	DX®
				SQ 	DX®

Module Layout

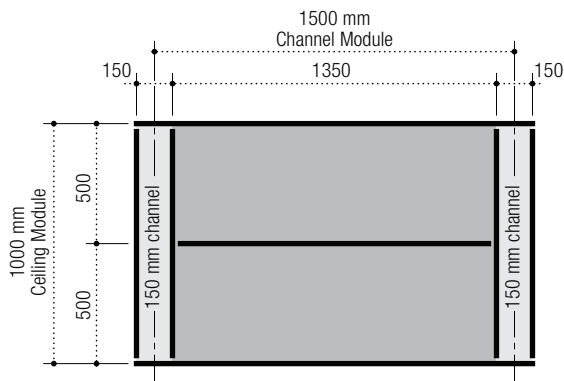

Panel Layout

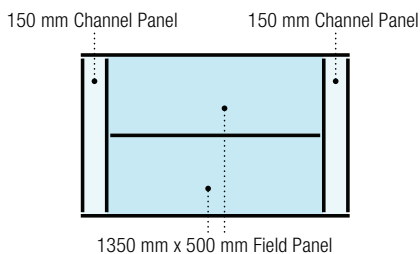

Suspension System Layout

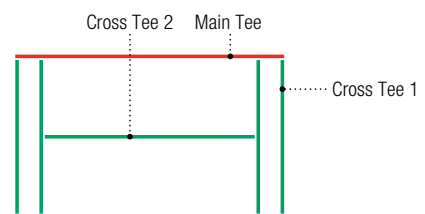



Step 1. Select Panels

Step 2. Select Edge for Panels

			FL/FLB		SL/SLT		SQ	
			Edge	Item No.	Edge	Item No.	Edge	Item No.
Field Panels	HALCYON™ CLIMAPLUS™	1350mm x 500mm	FL	<input type="checkbox"/> ME98360	SL	<input type="checkbox"/> ME97436	SQ	<input type="checkbox"/> ME97407
	MARS™ CLIMAPLUS™	1350mm x 500mm	FLB	<input type="checkbox"/> ME88845	SLT	<input type="checkbox"/> ME86547	SQ	<input type="checkbox"/> ME86519
	MARS™ CLIMAPLUS™ High-NRC	1350mm x 500mm	FLB	<input type="checkbox"/> ME86479	SLT	<input type="checkbox"/> ME86447	SQ	<input type="checkbox"/> ME86410

Channel Panels	HALCYON™ CLIMAPLUS™	150mm x 1000mm	FL	<input type="checkbox"/> ME98198	SL	<input type="checkbox"/> ME99271	SQ	<input type="checkbox"/> ME97227
	PANZ® Metal Panels, Solid	150mm x 1000mm	FL	<input type="checkbox"/> ME909953				

Step 3. Select Corresponding Grid for Selected Panels

			Qty	Item No.	Qty	Item No.	Qty	Item No.
Suspension Systems	CENTRICITEE™ DX™	Main Tee		<input type="checkbox"/> MEDXT24SP206				
		Cross Tee 1	2	<input type="checkbox"/> MEDXT1000				
		Cross Tee 2	1	<input type="checkbox"/> MEDXT1350				
	IDENTITEE™ DX™	Main Tee		<input type="checkbox"/> MEDXI24SP206				
		Cross Tee 1	2	<input type="checkbox"/> MEDXI1000				
		Cross Tee 2	1	<input type="checkbox"/> MEDXI1350				
	DONN® DX®	Main Tee				<input type="checkbox"/> MEDX24SP206		<input type="checkbox"/> MEDX24SP206
		Cross Tee 1			2	<input type="checkbox"/> MEDX1000	2	<input type="checkbox"/> MEDX1000
		Cross Tee 2			1	<input type="checkbox"/> MEDX1350	1	<input type="checkbox"/> MEDX1350

Suspension System Estimator

	Length	m ²	Main Tee Usage Per m ²	Cross Tee 1 Usage Per m ²	Cross Tee 2 Usage Per m ²	
System Module	1500mm	1.500	1.000	1.333	0.900	

Note: Multiply the ceiling area (SF) by the Usage Factor (UF). This calculation will determine lineal footage of suspension system components required. Please refer to page 11 for stabilizer bar usage.

Metric Systems



1000mm Ceiling Module

150mm Channel

System 107

1350mm x 1000mm Field Panel

Selector

Channel Width	Ceiling Module	On-Center Channel Spacing	Field Panels	Panel Edge	Suspension System
150mm	1000mm	1500mm	HALCYON™ CLIMAPLUS™ 1350mm x 1000mm	FL 	DXT™, DXI™, DXF™
				SL 	DX®
				SQ 	DX®

Module Layout

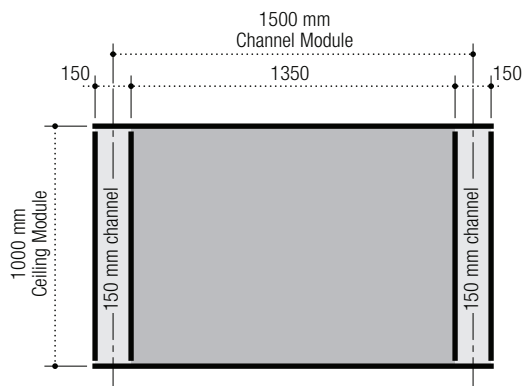

Panel Layout

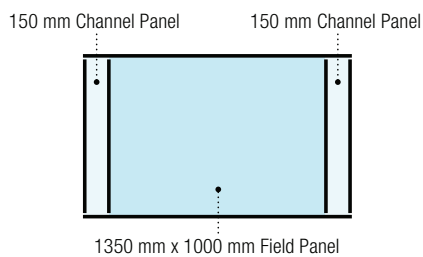

Suspension System Layout

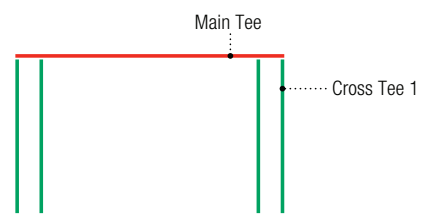

Order Information
System 107

1000mm Ceiling Module

150mm Channel

1350mm x 1000mm Field Panel



Step 1. Select Panels

Step 2. Select Edge for Panels

			FL/FLB		SL/SLT		SQ	
			Edge	Item No.	Edge	Item No.	Edge	Item No.
Field Panels	HALCYON™ CLIMAPLUS™	1350mm x 1000mm	FL	<input type="checkbox"/> ME97558	SL	<input type="checkbox"/> ME97529	SQ	<input type="checkbox"/> ME97501

Channel Panels	HALCYON™ CLIMAPLUS™	150mm x 1000mm	FL	<input type="checkbox"/> ME97541	SL	<input type="checkbox"/> ME97512	SQ	<input type="checkbox"/> ME97483
	PANZ® Metal Panels, Solid	150mm x 1000mm	FL	<input type="checkbox"/> ME909953				

Step 3. Select Corresponding Grid for Selected Panels

			Qty	Item No.	Qty	Item No.	Qty	Item No.
Suspension Systems	CENTRICITEE™ DXT™	Main Tee		<input type="checkbox"/> MEDXT24SP206				
		Cross Tee 1	2	<input type="checkbox"/> MEDXT1000				
	IDENTITEE™ DXI™	Main Tee		<input type="checkbox"/> MEDXI24SP206				
		Cross Tee 1	2	<input type="checkbox"/> MEDXI1000				
	DONN® DX®	Main Tee			<input type="checkbox"/> MEDX24SP206		<input type="checkbox"/> MEDX24SP206	
		Cross Tee 1			2	<input type="checkbox"/> MEDX1000	2	<input type="checkbox"/> MEDX1000

Suspension System Estimator

	Length	m ²	Main Tee Usage Per m ²	Cross Tee 1 Usage Per m ²	
System Module	1500mm	1.500	1.000	1.333	









Note: Multiply the ceiling area (SF) by the Usage Factor (UF). This calculation will determine lineal footage of suspension system components required. Please refer to page 11 for stabilizer bar usage.

Metric Systems
System 113

1200mm Ceiling Module

150mm Channel
525mm x 600mm Field Panel

Selector

Channel Width	Ceiling Module	On-Center Channel Spacing	Field Panels	Panel Edge	Suspension System
150mm	1200mm	1200mm	HALCYON™ CLIMAPLUS™ 525mm x 600mm	FL 	DXT™, DXI™, DXF™
				SL 	DX®
				SQ 	DX®, DXT™
			MARS™ CLIMAPLUS™ 525mm x 600mm	FLB 	DXT™, DXI™, DXF™
				SLT 	DX®
				SQ 	DX®, DXT™
			MARS™ CLIMAPLUS™ High-NRC 525mm x 600mm	FLB 	DXT™, DXI™, DXF™
				SLT 	DX®
				SQ 	DX®, DXT™

Module Layout

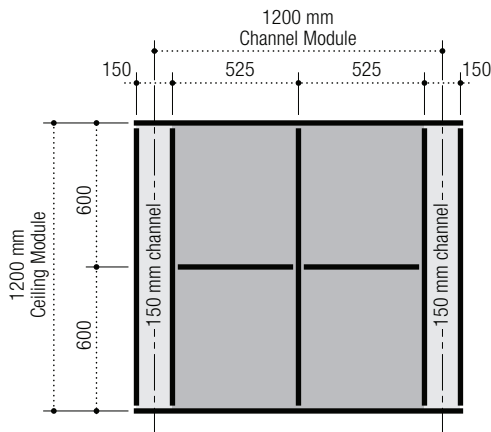

Panel Layout

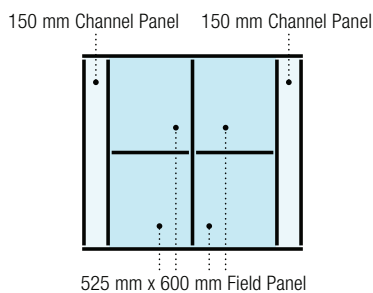

Suspension System Layout

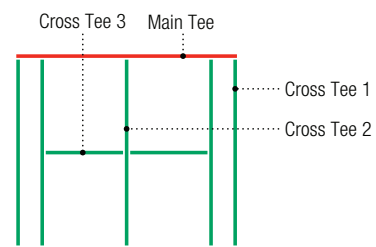

Order Information
System 113

1200mm Ceiling Module

150mm Channel

525mm x 600mm Field Panel



Step 1. Select Panels

Step 2. Select Edge for Panels

			FL/FLB		SL/SLT		SQ	
			Edge	Item No.	Edge	Item No.	Edge	Item No.
Field Panels	HALCYON™ CLIMAPLUS™	525mm x 600mm	FL	<input type="checkbox"/> ME98195	SL	<input type="checkbox"/> ME98220	SQ	<input type="checkbox"/> ME97411
	MARS™ CLIMAPLUS™	525mm x 600mm	FLB	<input type="checkbox"/> ME88840	SLT	<input type="checkbox"/> ME86550	SQ	<input type="checkbox"/> ME86522
	MARS™ CLIMAPLUS™ High-NRC	525mm x 600mm	FLB	<input type="checkbox"/> ME86483	SLT	<input type="checkbox"/> ME86451	SQ	<input type="checkbox"/> ME86414

Channel Panels	HALCYON™ CLIMAPLUS™	150mm x 1200mm	FL	<input type="checkbox"/> ME97572	SL	<input type="checkbox"/> ME97493	SQ	<input type="checkbox"/> ME97479
	MARS™ CLIMAPLUS™	150mm x 1200mm	FLB	<input type="checkbox"/> ME88887	SLT	<input type="checkbox"/> ME86542	SQ	<input type="checkbox"/> ME86325
	MARS™ CLIMAPLUS™ High-NRC	150mm x 1200mm	FLB	<input type="checkbox"/> ME86331	SLT	<input type="checkbox"/> ME86442	SQ	<input type="checkbox"/> ME86404
	PANZ® Metal Panels, Solid	150mm x 1200mm	FL	<input type="checkbox"/> ME909954				

Step 3. Select Corresponding Grid for Selected Panels

			Qty	Item No.	Qty	Item No.	Qty	Item No.
Suspension Systems	CENTRICITEE™ DXT™	Main Tee		<input type="checkbox"/> MEDXT24SP204				<input type="checkbox"/> MEDXT24SP204
		Cross Tee 1	2	<input type="checkbox"/> MEDXT1200			2	<input type="checkbox"/> MEDXT1200
		Cross Tee 2	1	<input type="checkbox"/> MEDXT1200			1	<input type="checkbox"/> MEDXT1200
		Cross Tee 3	2	<input type="checkbox"/> MEDXT525			2	<input type="checkbox"/> MEDXT525
	IDENTITEE™ DXI™	Main Tee		<input type="checkbox"/> MEDXI24SP204				
		Cross Tee 1	2	<input type="checkbox"/> MEDXI1200				
		Cross Tee 2	1	<input type="checkbox"/> MEDXI1200				
		Cross Tee 3	2	<input type="checkbox"/> MEDXI525				
	DONN® DX®	Main Tee				<input type="checkbox"/> MEDX24SP204		<input type="checkbox"/> MEDX24SP204
		Cross Tee 1			2	<input type="checkbox"/> MEDX1200	2	<input type="checkbox"/> MEDX1200
		Cross Tee 2			1	<input type="checkbox"/> MEDX1200	1	<input type="checkbox"/> MEDX1200
		Cross Tee 3			2	<input type="checkbox"/> MEDX525	2	<input type="checkbox"/> MEDX525

Suspension System Estimator

	Length	m ²	Main Tee Usage Per m ²	Cross Tee 1 Usage Per m ²	Cross Tee 2 Usage Per m ²	Cross Tee 3 Usage Per m ²
System Module	1200mm	1.440	0.833	1.667	0.833	0.729

Note: Multiply the ceiling area (SF) by the Usage Factor (UF). This calculation will determine lineal footage of suspension system components required. Please refer to page 11 for stabilizer bar usage.



Metric Systems
System 109

1200mm Ceiling Module

150mm Channel

1050mm x 600mm Field Panel

Selector

Channel Width	Ceiling Module	On-Center Channel Spacing	Field Panels	Panel Edge	Suspension System
150mm	1200mm	1200mm	HALCYON™ CLIMAPLUS™ 1050mm x 600mm	FL 	DXT™, DXI™, DXF™
				SL 	DX®
				SQ 	DX®

Module Layout

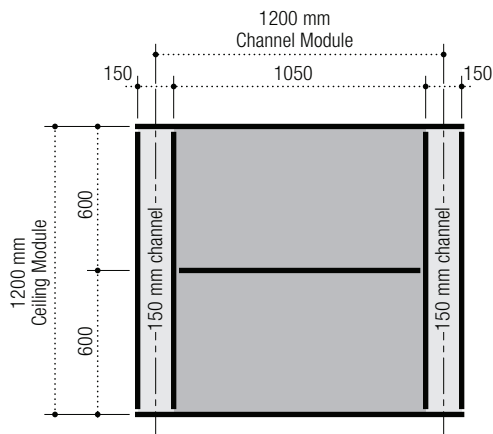

Panel Layout

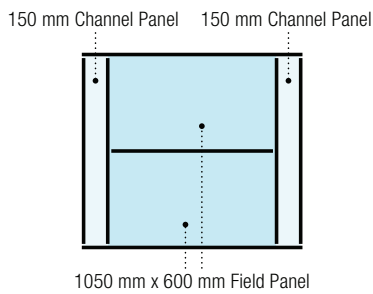

Suspension System Layout

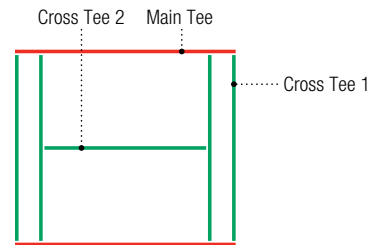

Order Information
System 109

1200mm Ceiling Module

150mm Channel

1050mm x 600mm Field Panel



Step 1. Select Panels

Step 2. Select Edge for Panels

			FL/FLB		SL/SLT		SQ	
			Edge	Item No.	Edge	Item No.	Edge	Item No.
Field Panels	HALCYON™ CLIMAPLUS™	1050mm x 600mm	FL	<input type="checkbox"/> ME97560	SL	<input type="checkbox"/> ME97531	SQ	<input type="checkbox"/> ME97503

Channel Panels	HALCYON™ CLIMAPLUS™	150mm x 1200mm	FL	<input type="checkbox"/> ME97572	SL	<input type="checkbox"/> ME97493	SQ	<input type="checkbox"/> ME97479
	PANZ® Metal Panels, Solid	150mm x 1200mm	FL	<input type="checkbox"/> ME909954				

Step 3. Select Corresponding Grid for Selected Panels

			Qty	Item No.	Qty	Item No.	Qty	Item No.
Suspension Systems	CENTRICITEE™ DXT™	Main Tee		<input type="checkbox"/> MEDXT24SP204				
		Cross Tee 1	2	<input type="checkbox"/> MEDXT1200				
		Cross Tee 2	1	<input type="checkbox"/> MEDXT1050				
	IDENTITEE™ DXI™	Main Tee		<input type="checkbox"/> MEDXI24SP204				
		Cross Tee 1	2	<input type="checkbox"/> MEDXI1200				
		Cross Tee 2	1	<input type="checkbox"/> MEDXI1050				
	DONN® DX®	Main Tee				<input type="checkbox"/> MEDX24SP204		<input type="checkbox"/> MEDX24SP204
		Cross Tee 1			2	<input type="checkbox"/> MEDX1200	2	<input type="checkbox"/> MEDX1200
		Cross Tee 2			1	<input type="checkbox"/> MEDX1050	1	<input type="checkbox"/> MEDX1050

Suspension System Estimator

	Length	m ²	Main Tee Usage Per m ²	Cross Tee 1 Usage Per m ²	Cross Tee 2 Usage Per m ²	
System Module	1200mm	1.440	0.833	1.667	0.729	



Note: Multiply the ceiling area (SF) by the Usage Factor (UF). This calculation will determine lineal footage of suspension system components required. Please refer to page 11 for stabilizer bar usage.

Metric Systems
System 101

1200 mm Ceiling Module

150mm Channel
1050mm x 1200mm Field Panel

Selector

Channel Width	Ceiling Module	On-Center Channel Spacing	Field Panels	Panel Edge	Suspension System
150mm	1200mm	1200mm	HALCYON™ CLIMAPLUS™ 1050mm x 1200mm	FL  SL  SQ 	DXT™, DXI™, DXF™ DX® DX®

Module Layout

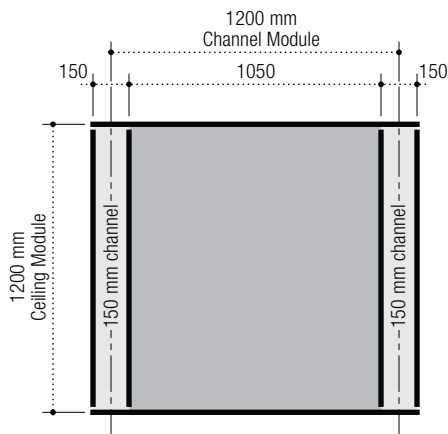

Panel Layout

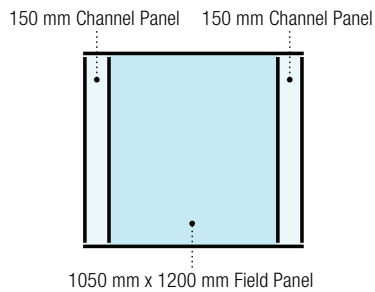

Suspension System Layout

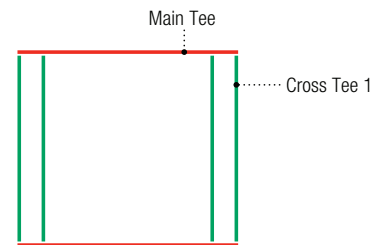

Order Information
System 101

1200mm Ceiling Module

150mm Channel

1050mm x 1200mm Field Panel



Step 1. Select Panels

Step 2. Select Edge for Panels

			FL/FLB		SL/SLT		SQ	
			Edge	Item No.	Edge	Item No.	Edge	Item No.
Field Panels	HALCYON™ CLIMAPLUS™	1050mm x 1200mm	FL	<input type="checkbox"/> ME97561	SL	<input type="checkbox"/> ME97532	SQ	<input type="checkbox"/> ME97504

Channel Panels	HALCYON™ CLIMAPLUS™	150mm x 1200mm	FL	<input type="checkbox"/> ME97572	SL	<input type="checkbox"/> ME97493	SQ	<input type="checkbox"/> ME97479
	PANZ® Metal Panels, Solid	150mm x 1200mm	FL	<input type="checkbox"/> ME909954				

Step 3. Select Corresponding Grid for Selected Panels











			Qty	Item No.	Qty	Item No.	Qty	Item No.
Suspension Systems	CENTRICITEE™ DXT™	Main Tee		<input type="checkbox"/> MEDXT24SP204				
		Cross Tee 1	2	<input type="checkbox"/> MEDXT1200				
	IDENTITEE™ DXI™	Main Tee		<input type="checkbox"/> MEDXI24SP204				
		Cross Tee 1	2	<input type="checkbox"/> MEDXI1200				
	DONN® DX®	Main Tee			<input type="checkbox"/> MEDX24SP204		<input type="checkbox"/> MEDX24SP204	
		Cross Tee 1			2	<input type="checkbox"/> MEDX1200	2	<input type="checkbox"/> MEDX1200

Suspension System Estimator

	Length	m ²	Main Tee Usage Per m ²	Cross Tee 1 Usage Per m ²	
System Module	1200mm	1.440	0.833	1.667	

Note: Multiply the ceiling area (SF) by the Usage Factor (UF). This calculation will determine lineal footage of suspension system components required. Please refer to page 11 for stabilizer bar usage.

Selector

Channel Width	Ceiling Module	On-Center Channel Spacing	Field Panels	Panel Edge	Suspension System
150mm	1200mm	1350mm	HALCYON™ CLIMAPLUS™ 600mm x 600mm	FL 	DXT™, DXI™, DXF™
				SL 	DX®
				SQ 	DX®, DXT™
			MARS™ CLIMAPLUS™ 600mm x 600mm	FLB 	DXT™, DXI™, DXF™
				SLT 	DX®
				SQ 	DX®, DXT™
			MARS™ CLIMAPLUS™ High-NRC 600mm x 600mm	FLB 	DXT™, DXI™, DXF™
				SLT 	DX®
				SQ 	DX®, DXT™
			PANZ® Metal Panels, Solid 600mm x 600mm	FL 	DXT™, DXI™

Module Layout

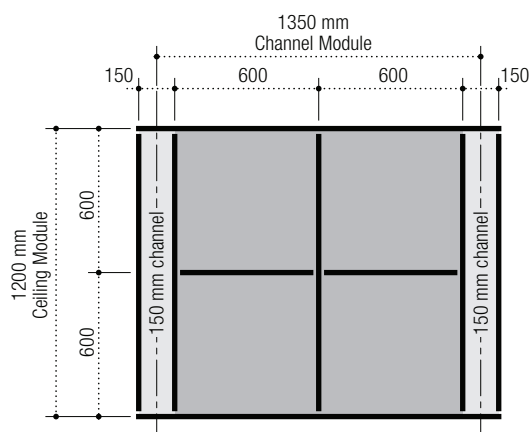

Panel Layout

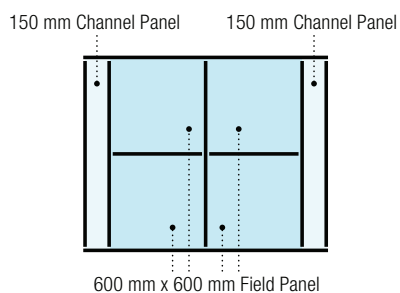

Suspension System Layout

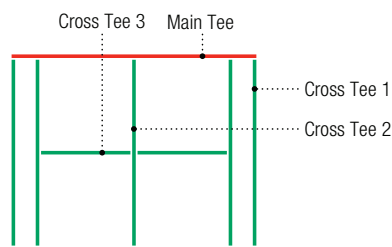

Order Information
System 127

1200mm Ceiling Module

150mm Channel

600mm x 600mm Field Panel



Step 1. Select Panels

Step 2. Select Edge for Panels

			FL/FLB		SL/SLT		SQ	
			Edge	Item No.	Edge	Item No.	Edge	Item No.
Field Panels	HALCYON™ CLIMAPLUS™	600mm x 600mm	FL	<input type="checkbox"/> ME98225	SL	<input type="checkbox"/> ME98223	SQ	<input type="checkbox"/> ME98221
	MARS™ CLIMAPLUS™	600mm x 600mm	FLB	<input type="checkbox"/> ME86985	SLT	<input type="checkbox"/> ME86785	SQ	<input type="checkbox"/> ME86185
	MARS™ CLIMAPLUS™ High-NRC	600mm x 600mm	FLB	<input type="checkbox"/> ME87100	SLT	<input type="checkbox"/> ME87200	SQ	<input type="checkbox"/> ME86100
	PANZ® Metal Panels, Solid	600mm x 600mm	FL	<input type="checkbox"/> ME909975				

Channel Panels	HALCYON™ CLIMAPLUS™	150mm x 1200mm	FL	<input type="checkbox"/> ME97572	SL	<input type="checkbox"/> ME97493	SQ	<input type="checkbox"/> ME97479
	MARS™ CLIMAPLUS™	150mm x 1200mm	FLB	<input type="checkbox"/> ME88887	SLT	<input type="checkbox"/> ME86542	SQ	<input type="checkbox"/> ME86325
	MARS™ CLIMAPLUS™ High-NRC	150mm x 1200mm	FLB	<input type="checkbox"/> ME86331	SLT	<input type="checkbox"/> ME86442	SQ	<input type="checkbox"/> ME86404
	PANZ® Metal Panels, Solid	150mm x 1200mm	FL	<input type="checkbox"/> ME909954				

Step 3. Select Corresponding Grid for Selected Panels

			Qty	Item No.	Qty	Item No.	Qty	Item No.
Suspension Systems	CENTRICITEE™ DXT™	Main Tee		<input type="checkbox"/> MEDXT3600				<input type="checkbox"/> MEDXT3600
		Cross Tee 1	2	<input type="checkbox"/> MEDXT1200			2	<input type="checkbox"/> MEDXT1200
		Cross Tee 2	1	<input type="checkbox"/> MEDXT1200			1	<input type="checkbox"/> MEDXT1200
		Cross Tee 3	2	<input type="checkbox"/> MEDXT600			2	<input type="checkbox"/> MEDXT600
	IDENTITEE™ DXI™	Main Tee		<input type="checkbox"/> MEDXI3600				
		Cross Tee 1	2	<input type="checkbox"/> MEDXI1200				
		Cross Tee 2	1	<input type="checkbox"/> MEDXI1200				
		Cross Tee 3	2	<input type="checkbox"/> MEDXI600				
	DONN® DX®	Main Tee				<input type="checkbox"/> MEDX3600		<input type="checkbox"/> MEDX3600
		Cross Tee 1			2	<input type="checkbox"/> MEDX1200	2	<input type="checkbox"/> MEDX1200
		Cross Tee 2			1	<input type="checkbox"/> MEDX1200	1	<input type="checkbox"/> MEDX1200
		Cross Tee 3			2	<input type="checkbox"/> MEDX600	2	<input type="checkbox"/> MEDX600

Suspension System Estimator

	Length	m ²	Main Tee Usage Per m ²	Cross Tee 1 Usage Per m ²	Cross Tee 2 Usage Per m ²	Cross Tee 3 Usage Per m ²
System Module	1350mm	1.620	0.833	1.481	0.741	0.741

Note: Multiply the ceiling area (SF) by the Usage Factor (UF). This calculation will determine lineal footage of suspension system components required. Please refer to page 11 for stabilizer bar usage.

Metric Systems











System 130

1200mm Ceiling Module

150mm Channel

1200mm x 600mm Field Panel

Selector

Channel Width	Ceiling Module	On-Center Channel Spacing	Field Panels	Panel Edge	Suspension System
150mm	1200mm	1350mm	HALCYON™ CLIMAPLUS™ 1200mm x 600mm	FL 	DXT™, DXI™, DXF™
				SL 	DX®
				SQ 	DX®
			MARS™ CLIMAPLUS™ 1200mm x 600mm	FLB 	DXT™, DXI™, DXF™
				SLT 	DX®
				SQ 	DX®
			MARS™ CLIMAPLUS™ High-NRC 1200mm x 600mm	FLB 	DXT™, DXI™, DXF™
				SLT 	DX®
				SQ 	DX®
			PANZ® Metal Panels, Solid 1200mm x 600mm	FL 	DXT™, DXI™

Module Layout

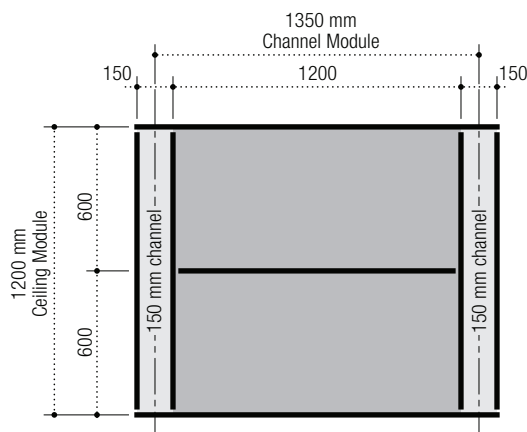

Panel Layout

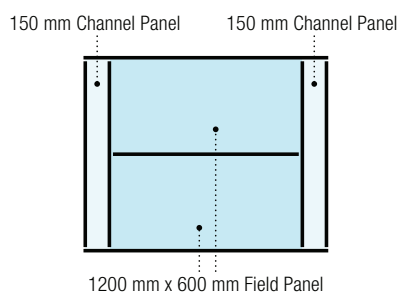

Suspension System Layout

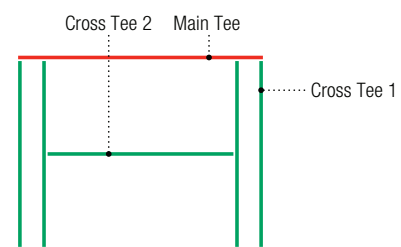

Order Information
System 130

1200mm Ceiling Module

150mm Channel

1200mm x 600mm Field Panel



Step 1. Select Panels

Step 2. Select Edge for Panels

			FL/FLB		SL/SLT		SQ	
			Edge	Item No.	Edge	Item No.	Edge	Item No.
Field Panels	HALCYON™ CLIMAPLUS™	1200mm x 600mm	FL	<input type="checkbox"/> ME98245	SL	<input type="checkbox"/> ME98243	SQ	<input type="checkbox"/> ME98241
	MARS™ CLIMAPLUS™	1200mm x 600mm	FLB	<input type="checkbox"/> ME88985	SLT	<input type="checkbox"/> ME88785	SQ	<input type="checkbox"/> ME88185
	MARS™ CLIMAPLUS™ High-NRC	1200mm x 600mm	FLB	<input type="checkbox"/> ME89500	SLT	<input type="checkbox"/> ME89600	SQ	<input type="checkbox"/> ME86300
	PANZ® Metal Panels, Solid	1200mm x 600mm	FL	<input type="checkbox"/> ME909974				

Channel Panels	HALCYON™ CLIMAPLUS™	150mm x 1200mm	FL	<input type="checkbox"/> ME97572	SL	<input type="checkbox"/> ME97493	SQ	<input type="checkbox"/> ME97479
	MARS™ CLIMAPLUS™	150mm x 1200mm	FLB	<input type="checkbox"/> ME88887	SLT	<input type="checkbox"/> ME86542	SQ	<input type="checkbox"/> ME86325
	MARS™ CLIMAPLUS™ High-NRC	150mm x 1200mm	FLB	<input type="checkbox"/> ME86331	SLT	<input type="checkbox"/> ME86442	SQ	<input type="checkbox"/> ME86404
	PANZ® Metal Panels, Solid	150mm x 1200mm	FL	<input type="checkbox"/> ME909954				

Step 3. Select Corresponding Grid for Selected Panels

			Qty	Item No.	Qty	Item No.	Qty	Item No.	
Suspension Systems	CENTRICITEE™ DX™ (Use with PANZ®)	Main Tee		<input type="checkbox"/> MEDXT3600					
		Cross Tee 1	2	<input type="checkbox"/> MEDXT1200					
		Cross Tee 2	1	<input type="checkbox"/> MEDXT1200					
	IDENTITEE™ DX™	Main Tee		<input type="checkbox"/> MEDXI3600					
		Cross Tee 1	2	<input type="checkbox"/> MEDXI1200					
		Cross Tee 2	1	<input type="checkbox"/> MEDXI1200					
	DONN® DX®	Main Tee				<input type="checkbox"/> MEDX3600		<input type="checkbox"/> MEDX3600	
		Cross Tee 1				2	<input type="checkbox"/> MEDX1200	2	<input type="checkbox"/> MEDX1200
		Cross Tee 2				1	<input type="checkbox"/> MEDX1200	1	<input type="checkbox"/> MEDX1200

Suspension System Estimator

	Length	m ²	Main Tee Usage Per m ²	Cross Tee 1 Usage Per m ²	Cross Tee 2 Usage Per m ²	
System Module	1350mm	1.620	0.833	1.481	0.741	



Note: Multiply the ceiling area (SF) by the Usage Factor (UF). This calculation will determine lineal footage of suspension system components required. Please refer to page 11 for stabilizer bar usage.

Metric Systems
System 106

1200mm Ceiling Module

150mm Channel
1200mm x 1200mm Field Panel

Selector

Channel Width	Ceiling Module	On-Center Channel Spacing	Field Panels	Panel Edge	Suspension System
150mm	1200mm	1350mm	HALCYON™ CLIMAPLUS™ 1200mm x 1200mm	FL  SL  SQ 	DXT™, DXI™, DXF™ DX® DX®

Module Layout

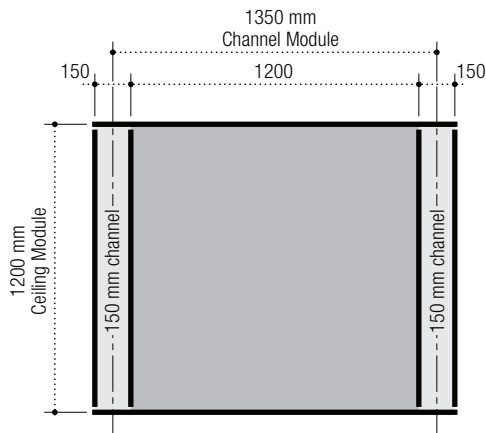

Panel Layout

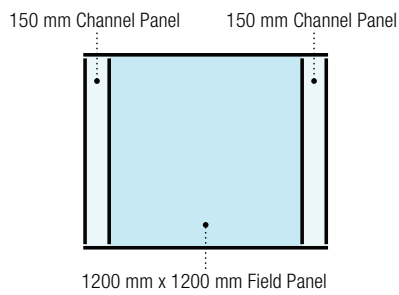

Suspension System Layout

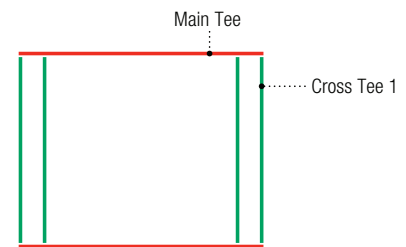

Order Information
System 106

1200mm Ceiling Module

150mm Channel

1200mm x 1200mm Field Panel



Step 1. Select Panels

Step 2. Select Edge for Panels

			FL/FLB		SL/SLT		SQ	
			Edge	Item No.	Edge	Item No.	Edge	Item No.
Field Panels	HALCYON™ CLIMAPLUS™	1200mm x 1200mm	FL	<input type="checkbox"/> ME98445	SL	<input type="checkbox"/> ME98443	SQ	<input type="checkbox"/> ME98441

Channel Panels	HALCYON™ CLIMAPLUS™	150mm x 1200mm	FL	<input type="checkbox"/> ME97572	SL	<input type="checkbox"/> ME97493	SQ	<input type="checkbox"/> ME97479
	PANZ® Metal Panels, Solid	150mm x 1200mm	FL	<input type="checkbox"/> ME909954				

Step 3. Select Corresponding Grid for Selected Panels

			Qty	Item No.	Qty	Item No.	Qty	Item No.
Suspension Systems	CENTRICITEE™ DXT™	Main Tee		<input type="checkbox"/> MEDXT3600				
		Cross Tee 1	2	<input type="checkbox"/> MEDXT1200				
	IDENTITEE™ DXI™	Main Tee		<input type="checkbox"/> MEDXI3600				
		Cross Tee 1	2	<input type="checkbox"/> MEDXI1200				
	DONN® DX®	Main Tee			<input type="checkbox"/> MEDX3600		<input type="checkbox"/> MEDX3600	
		Cross Tee 1			2	<input type="checkbox"/> MEDX1200	2	<input type="checkbox"/> MEDX1200

Suspension System Estimator

	Length	m ²	Main Tee Usage Per m ²	Cross Tee 1 Usage Per m ²	
System Module	1350mm	1.620	0.833	1.481	

Note: Multiply the ceiling area (SF) by the Usage Factor (UF). This calculation will determine lineal footage of suspension system components required. Please refer to page 11 for stabilizer bar usage.











Metric Systems
System 120

1200mm Ceiling Module

150mm Channel

1800mm x 300mm Field Panel

Selector

Channel Width	Ceiling Module	On-Center Channel Spacing	Field Panels	Panel Edge	Suspension System
150mm	1200mm	1950mm	HALCYON™ CLIMAPLUS™ 1800mm x 300mm	FL 	DXT™, DXI™, DXF™
				SL 	DX®
				SQ 	DX®
			MARS™ CLIMAPLUS™ 1800mm x 300mm	FLB 	DXT™, DXI™, DXF™
				SLT 	DX®
				SQ 	DX®
			MARS™ CLIMAPLUS™ High-NRC 1800mm x 300mm	FLB 	DXT™, DXI™, DXF™
				SLT 	DX®
				SQ 	DX®
			PANZ® Metal Panels, Solid 1800mm x 300mm	FL 	DXT™, DXI™

Module Layout

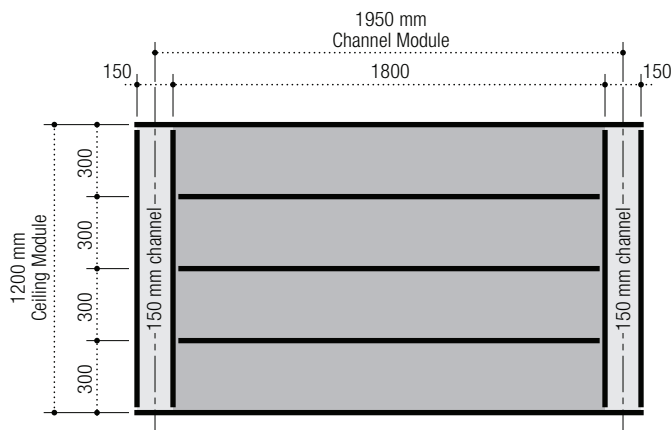

Panel Layout

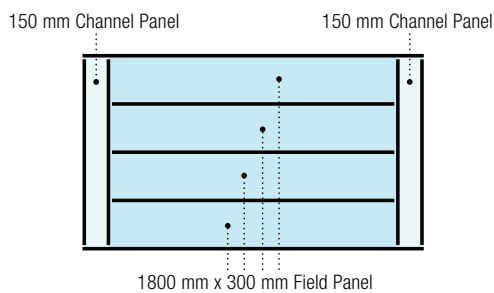

Suspension System Layout

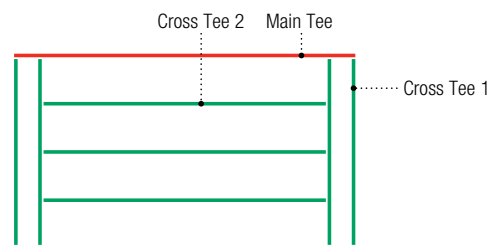

Order Information
System 120

1200mm Ceiling Module

150mm Channel

1800mm x 300mm Field Panel

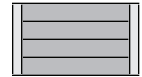

Step 1. Select Panels

Step 2. Select Edge for Panels

			FL/FLB		SL/SLT		SQ	
			Edge	Item No.	Edge	Item No.	Edge	Item No.
Field Panels	HALCYON™ CLIMAPLUS™	1800mm x 300mm	FL	<input type="checkbox"/> ME97574	SL	<input type="checkbox"/> ME97433	SQ	<input type="checkbox"/> ME97405
	MARS™ CLIMAPLUS™	1800mm x 300mm	FLB	<input type="checkbox"/> ME86570	SLT	<input type="checkbox"/> ME86546	SQ	<input type="checkbox"/> ME86518
	MARS™ CLIMAPLUS™ High-NRC	1800mm x 300mm	FLB	<input type="checkbox"/> ME86478	SLT	<input type="checkbox"/> ME86446	SQ	<input type="checkbox"/> ME86409
	PANZ® Metal Panels, Solid	1800mm x 300mm	FL	<input type="checkbox"/> ME909956				

Channel Panels	HALCYON™ CLIMAPLUS™	150mm x 1200mm	FL	<input type="checkbox"/> ME97572	SL	<input type="checkbox"/> ME97493	SQ	<input type="checkbox"/> ME97479
	MARS™ CLIMAPLUS™	150mm x 1200mm	FLB	<input type="checkbox"/> ME88887	SLT	<input type="checkbox"/> ME86542	SQ	<input type="checkbox"/> ME86325
	MARS™ CLIMAPLUS™ High-NRC	150mm x 1200mm	FLB	<input type="checkbox"/> ME86331	SLT	<input type="checkbox"/> ME86442	SQ	<input type="checkbox"/> ME86404
	PANZ® Metal Panels, Solid	150mm x 1200mm	FL	<input type="checkbox"/> ME909954				

Step 3. Select Corresponding Grid for Selected Panels











			Qty	Item No.	Qty	Item No.	Qty	Item No.
Suspension Systems	CENTRICITEE™ DXT™	Main Tee		<input type="checkbox"/> MEDXT3600				
		Cross Tee 1	1	<input type="checkbox"/> MEDXT1200				
		Cross Tee 2	3	<input type="checkbox"/> MEDXT1800				
	IDENTITEE™ DXI™	Main Tee		<input type="checkbox"/> MEDXI3600				
		Cross Tee 1	1	<input type="checkbox"/> MEDXI1200				
		Cross Tee 2	3	<input type="checkbox"/> MEDXI1800				
	DONN® DX®	Main Tee			<input type="checkbox"/> MEDX3600		<input type="checkbox"/> MEDX3600	
		Cross Tee 1			1	<input type="checkbox"/> MEDX1200	1	<input type="checkbox"/> MEDX1200
		Cross Tee 2			3	<input type="checkbox"/> MEDX1800	3	<input type="checkbox"/> MEDX1800

Suspension System Estimator

	Length	m ²	Main Tee Usage Per m ²	Cross Tee 1 Usage Per m ²	Cross Tee 2 Usage Per m ²	
System Module	1950mm	2.340	0.833	0.513	2.308	

Note: Multiply the ceiling area (SF) by the Usage Factor (UF). This calculation will determine lineal footage of suspension system components required. Please refer to page 11 for stabilizer bar usage.

Selector

Channel Width	Ceiling Module	On-Center Channel Spacing	Field Panels	Panel Edge	Suspension System
150mm	1200mm	1950mm	HALCYON™ CLIMAPLUS™ 1800mm x 600mm	FL 	DXT™, DXI™, DXF™
				SL 	DX®
				SQ 	DX®
			MARS™ CLIMAPLUS™ 1800mm x 600mm	FLB 	DXT™, DXI™, DXF™
				SLT 	DX®
				SQ 	DX®
			MARS™ CLIMAPLUS™ High-NRC 1800mm x 600mm	FLB 	DXT™, DXI™, DXF™
				SLT 	DX®
				SQ 	DX®
			PANZ® Metal Panels, Solid 1800mm x 600mm	FL 	DXT™, DXI™

Module Layout

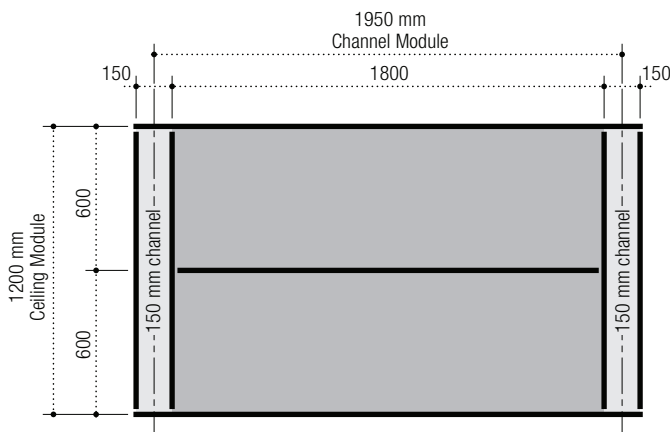

Panel Layout

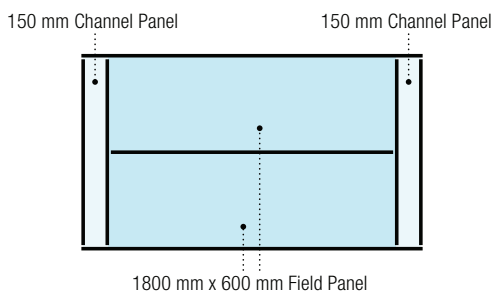

Suspension System Layout

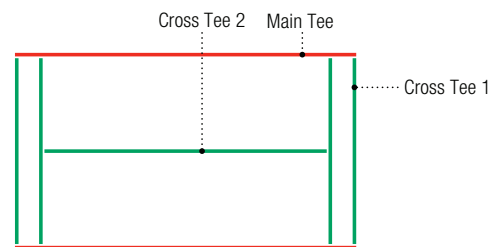

Order Information
System 137

1200mm Ceiling Module

150mm Channel

1800mm x 600mm Field Pane



Step 1. Select Panels

Step 2. Select Edge for Panels

			FL/FLB		SL/SLT		SQ	
			Edge	Item No.	Edge	Item No.	Edge	Item No.
Field Panels	HALCYON™ CLIMAPLUS™	1800mm x 600mm	FL	<input type="checkbox"/> ME97553	SL	<input type="checkbox"/> ME97445	SQ	<input type="checkbox"/> ME99234
	MARS™ CLIMAPLUS™	1800mm x 600mm	FLB	<input type="checkbox"/> ME88996	SLT	<input type="checkbox"/> ME86166	SQ	<input type="checkbox"/> ME86223
	MARS™ CLIMAPLUS™ High-NRC	1800mm x 600mm	FLB	<input type="checkbox"/> ME89670	SLT	<input type="checkbox"/> ME89660	SQ	<input type="checkbox"/> ME86360
	PANZ® Metal Panels, Solid	1800mm x 600mm	FL	<input type="checkbox"/> ME909970				

Channel Panels	HALCYON™ CLIMAPLUS™	150mm x 1200mm	FL	<input type="checkbox"/> ME97572	SL	<input type="checkbox"/> ME97493	SQ	<input type="checkbox"/> ME97479
	MARS™ CLIMAPLUS™	150mm x 1200mm	FLB	<input type="checkbox"/> ME88887	SLT	<input type="checkbox"/> ME86542	SQ	<input type="checkbox"/> ME86325
	MARS™ CLIMAPLUS™ High-NRC	150mm x 1200mm	FLB	<input type="checkbox"/> ME86331	SLT	<input type="checkbox"/> ME86442	SQ	<input type="checkbox"/> ME86404
	PANZ® Metal Panels, Solid	150mm x 1200mm	FL	<input type="checkbox"/> ME90954				

Step 3. Select Corresponding Grid for Selected Panels









			Qty	Item No.	Qty	Item No.	Qty	Item No.
Suspension Systems	CENTRICITEE™ DXT™	Main Tee		<input type="checkbox"/> MEDXT3600				
		Cross Tee 1	2	<input type="checkbox"/> MEDXT1200				
		Cross Tee 2	2	<input type="checkbox"/> MEDXT1800				
	IDENTITEE™ DXI™	Main Tee		<input type="checkbox"/> MEDXI3600				
		Cross Tee 1	2	<input type="checkbox"/> MEDXI1200				
		Cross Tee 2	2	<input type="checkbox"/> MEDXI1800				
	DONN® DX®	Main Tee			<input type="checkbox"/> MEDX3600		<input type="checkbox"/> MEDX3600	
		Cross Tee 1			2	<input type="checkbox"/> MEDX1200	2	<input type="checkbox"/> MEDX1200
		Cross Tee 2			2	<input type="checkbox"/> MEDX1800	2	<input type="checkbox"/> MEDX1800

Suspension System Estimator

	Length	m ²	Main Tee Usage Per m ²	Cross Tee 1 Usage Per m ²	Cross Tee 2 Usage Per m ²	
System Module	1950mm	2.340	0.833	1.026	1.538	

Note: Multiply the ceiling area (SF) by the Usage Factor (UF). This calculation will determine lineal footage of suspension system components required. Please refer to page 11 for stabilizer bar usage.

Selector

Channel Width	Ceiling Module	On-Center Channel Spacing	Field Panels	Panel Edge	Suspension System
150mm	1500mm	1500mm	HALCYON™ CLIMAPLUS™ 1350mm x 500mm	FL 	DXT™, DXI™, DXF™
				SL 	DX®
				SQ 	DX®
			MARS™ CLIMAPLUS™ 1350mm x 500mm	FLB 	DXT™, DXI™, DXF™
				SLT 	DX®
				SQ 	DX®
			MARS™ CLIMAPLUS™ High-NRC 1350mm x 500mm	FLB 	DXT™, DXI™, DXF™
				SLT 	DX®
				SQ 	DX®

Module Layout

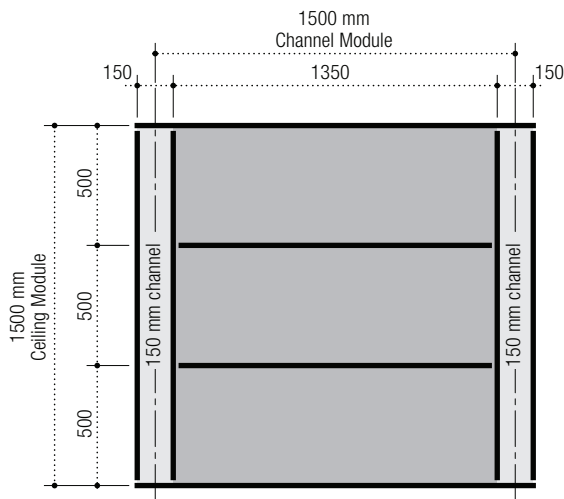

Panel Layout

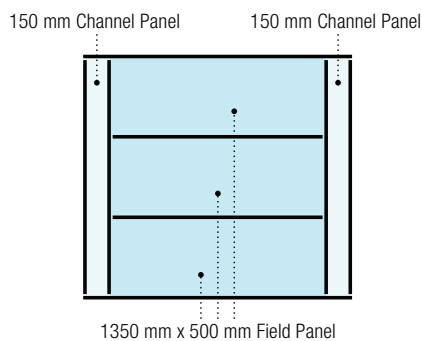

Suspension System Layout

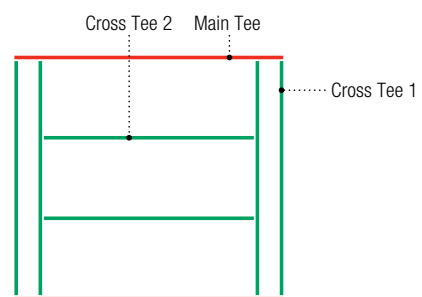



Step 1. Select Panels

Step 2. Select Edge for Panels

			FL/FLB		SL/SLT		SQ	
			Edge	Item No.	Edge	Item No.	Edge	Item No.
Field Panels	HALCYON™ CLIMAPLUS™	1350mm x 500mm	FL	<input type="checkbox"/> ME98360	SL	<input type="checkbox"/> ME97436	SQ	<input type="checkbox"/> ME97407
	MARS™ CLIMAPLUS™	1350mm x 500mm	FLB	<input type="checkbox"/> ME88845	SLT	<input type="checkbox"/> ME86547	SQ	<input type="checkbox"/> ME86519
	MARS™ CLIMAPLUS™ High-NRC	1350mm x 500mm	FLB	<input type="checkbox"/> ME86479	SLT	<input type="checkbox"/> ME86447	SQ	<input type="checkbox"/> ME86410
	PANZ® Metal Panels, Solid	1350mm x 500mm	FL	<input type="checkbox"/> ME909963				
Channel Panels	HALCYON™ CLIMAPLUS™	150mm x 1500mm	FL	<input type="checkbox"/> ME97573	SL	<input type="checkbox"/> ME97570	SQ	<input type="checkbox"/> ME97490
	MARS™ CLIMAPLUS™	150mm x 1500mm	FLB	<input type="checkbox"/> ME86835	SLT	<input type="checkbox"/> ME86543	SQ	<input type="checkbox"/> ME86507
	MARS™ CLIMAPLUS™ High-NRC	150mm x 1500mm	FLB	<input type="checkbox"/> ME86333	SLT	<input type="checkbox"/> ME86443	SQ	<input type="checkbox"/> ME86145

Step 3. Select Corresponding Grid for Selected Panels

			Qty	Item No.	Qty	Item No.	Qty	Item No.
Suspension Systems	CENTRICITEE™ DXT™	Main Tee		<input type="checkbox"/> MEDXT24SP206				
		Cross Tee 1	2	<input type="checkbox"/> MEDXT1500				
		Cross Tee 2	2	<input type="checkbox"/> MEDXT1350				
	IDENTITEE™ DXI™	Main Tee		<input type="checkbox"/> MEDXI24SP206				
		Cross Tee 1	2	<input type="checkbox"/> MEDXI1500				
		Cross Tee 2	2	<input type="checkbox"/> MEDXI1350				
	DONN® DX®	Main Tee			<input type="checkbox"/> MEDX24SP206		<input type="checkbox"/> MEDX24SP206	
		Cross Tee 1			2	<input type="checkbox"/> MEDX1500	2	<input type="checkbox"/> MEDX1500
		Cross Tee 2			2	<input type="checkbox"/> MEDX1350	2	<input type="checkbox"/> MEDX1350

Suspension System Estimator

	Length	m ²	Main Tee Usage Per m ²	Cross Tee 1 Usage Per m ²	Cross Tee 2 Usage Per m ²	
System Module	1500mm	1.500	1.000	2.000	1.800	



Note: Multiply the ceiling area (SF) by the Usage Factor (UF). This calculation will determine lineal footage of suspension system components required. Please refer to page 11 for stabilizer bar usage.

Metric Systems
System 145

1500mm Ceiling Module

150mm Channel
1350mm x 1500mm Field Panel

Selector

Channel Width	Ceiling Module	On-Center Channel Spacing	Field Panels	Panel Edge	Suspension System
150mm	1500mm	1500mm	HALCYON™ CLIMAPLUS™ 1350mm x 1500mm	FL  SL  SQ 	DXT™, DXI™, DXF™ DX® DX®

Module Layout

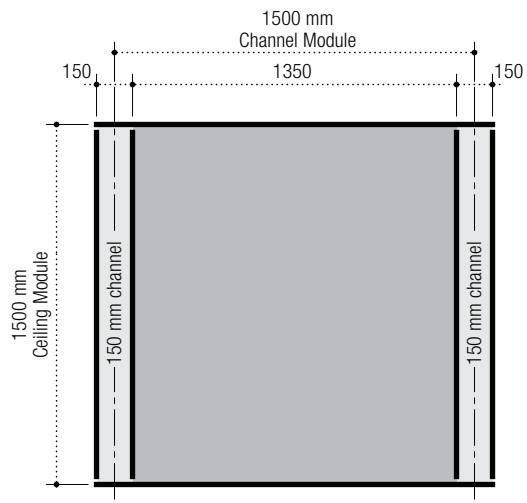

Panel Layout

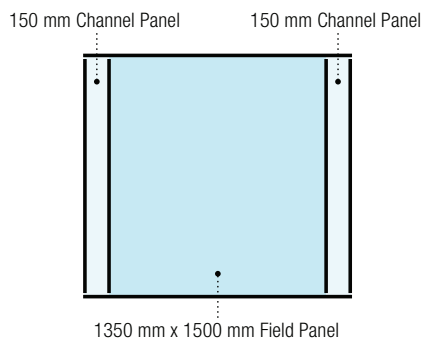

Suspension System Layout

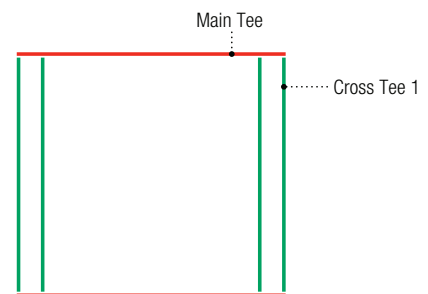

Order Information
System 145

1500mm Ceiling Module

150mm Channel

1350mm x 1500mm Field Panel

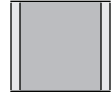

Step 1. Select Panels

Step 2. Select Edge for Panels

			FL/FLB		SL/SLT		SQ	
			Edge	Item No.	Edge	Item No.	Edge	Item No.
Field Panels	HALCYON™ CLIMAPLUS™	1350mm x 1500mm	FL	<input type="checkbox"/> ME97565	SL	<input type="checkbox"/> ME97536	SQ	<input type="checkbox"/> ME97507

Channel Panels	HALCYON™ CLIMAPLUS™	150mm x 1500mm	FL	<input type="checkbox"/> ME97573	SL	<input type="checkbox"/> ME97570	SQ	<input type="checkbox"/> ME97490
-----------------------	---------------------	----------------	----	----------------------------------	----	----------------------------------	----	----------------------------------

Step 3. Select Corresponding Grid for Selected Panels

			Qty	Item No.	Qty	Item No.	Qty	Item No.
Suspension Systems	CENTRICITEE™ DXT™	Main Tee		<input type="checkbox"/> MEDXT24SP206				
		Cross Tee 1	2	<input type="checkbox"/> MEDXT1500				
	IDENTITEE™ DXI™	Main Tee		<input type="checkbox"/> MEDXI24SP206				
		Cross Tee 1	2	<input type="checkbox"/> MEDXI1500				
	DONN® DX®	Main Tee			1	<input type="checkbox"/> MEDX24SP206		<input type="checkbox"/> MEDX24SP206
		Cross Tee 1			2	<input type="checkbox"/> MEDX1500	2	<input type="checkbox"/> MEDX1500

Suspension System Estimator

	Length	m ²	Main Tee Usage Per m ²	Cross Tee 1 Usage Per m ²	
System Module	1500mm	2.250	0.667	1.333	









Note: Multiply the ceiling area (SF) by the Usage Factor (UF). This calculation will determine lineal footage of suspension system components required. Please refer to page 11 for stabilizer bar usage.

Metric Systems
System 143

1500mm Ceiling Module

150mm Channel
675mm x 750mm Field Panel

Selector

Channel Width	Ceiling Module	On-Center Channel Spacing	Field Panels	Panel Edge	Suspension System
150mm	1500mm	1500mm	HALCYON™ CLIMAPLUS™ 675mm x 750mm	FL 	DXT™, DXI™, DXF™
				SL 	DX®
				SQ 	DX®
			MARS™ CLIMAPLUS™ 675mm x 750mm	FLB 	DXT™, DXI™, DXF™
				SLT 	DX®
				SQ 	DX®
			MARS™ CLIMAPLUS™ High-NRC 675mm x 750mm	FLB 	DXT™, DXI™, DXF™
				SLT 	DX®
				SQ 	DX®

Module Layout

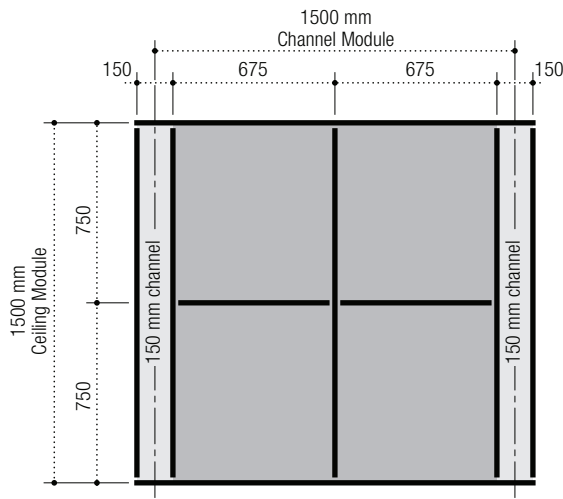

Panel Layout

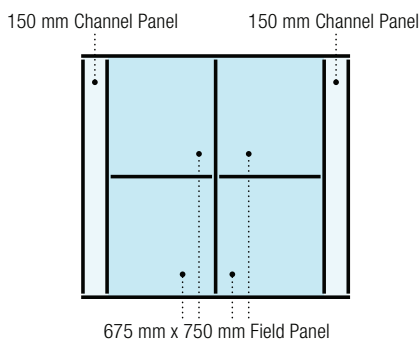

Suspension System Layout

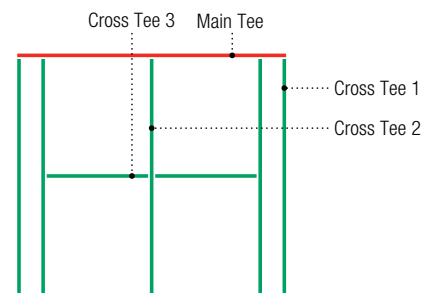

Order Information
System 143

1500mm Ceiling Module

150mm Channel
675mm x 750mm Field Panel

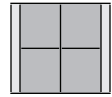

Step 1. Select Panels

Step 2. Select Edge for Panels

			FL/FLB		SL/SLT		SQ	
			Edge	Item No.	Edge	Item No.	Edge	Item No.
Field Panels	HALCYON™ CLIMAPLUS™	675mm x 750mm	FL	<input type="checkbox"/> ME98333	SL	<input type="checkbox"/> ME97447	SQ	<input type="checkbox"/> ME97417
	MARS™ CLIMAPLUS™	675mm x 750mm	FLB	<input type="checkbox"/> ME86850	SLT	<input type="checkbox"/> ME86557	SQ	<input type="checkbox"/> ME86530
	MARS™ CLIMAPLUS™ High-NRC	675mm x 750mm	FLB	<input type="checkbox"/> ME86490	SLT	<input type="checkbox"/> ME86458	SQ	<input type="checkbox"/> ME86421

Channel Panels	HALCYON™ CLIMAPLUS™	150mm x 1500mm	FL	<input type="checkbox"/> ME97573	SL	<input type="checkbox"/> ME97570	SQ	<input type="checkbox"/> ME97490
	MARS™ CLIMAPLUS™	150mm x 1500mm	FLB	<input type="checkbox"/> ME86835	SLT	<input type="checkbox"/> ME86543	SQ	<input type="checkbox"/> ME86507
	MARS™ CLIMAPLUS™ High-NRC	150mm x 1500mm	FLB	<input type="checkbox"/> ME86333	SLT	<input type="checkbox"/> ME86443	SQ	<input type="checkbox"/> ME86145

Step 3. Select Corresponding Grid for Selected Panels











			Qty	Item No.	Qty	Item No.	Qty	Item No.
Suspension Systems	CENTRICITEE™ DX™	Main Tee		<input type="checkbox"/> MEDXT24SP206				
		Cross Tee 1	2	<input type="checkbox"/> MEDXT1500				
		Cross Tee 2	1	<input type="checkbox"/> MEDXT1500				
		Cross Tee 3	2	<input type="checkbox"/> MEDXT675				
	IDENTITEE™ DX™	Main Tee		<input type="checkbox"/> MEDXI24SP206				
		Cross Tee 1	2	<input type="checkbox"/> MEDXI1500				
		Cross Tee 2	1	<input type="checkbox"/> MEDXI1500				
		Cross Tee 3	2	<input type="checkbox"/> MEDXI675				
	DONN® DX®	Main Tee			<input type="checkbox"/> MEDX24SP206		<input type="checkbox"/> MEDX24SP206	
		Cross Tee 1			2	<input type="checkbox"/> MEDX1500	2	<input type="checkbox"/> MEDX1500
		Cross Tee 2			1	<input type="checkbox"/> MEDX1500	1	<input type="checkbox"/> MEDX1500
		Cross Tee 3			2	<input type="checkbox"/> MEDX675	2	<input type="checkbox"/> MEDX675

Suspension System Estimator

	Length	m ²	Main Tee Usage Per m ²	Cross Tee 1 Usage Per m ²	Cross Tee 2 Usage Per m ²	Cross Tee 3 Usage Per m ²
System Module	1500mm	1.500	1.000	2.000	1.000	0.900

Note: Multiply the ceiling area (SF) by the Usage Factor (UF). This calculation will determine lineal footage of suspension system components required. Please refer to page 11 for stabilizer bar usage.

Selector

Channel Width	Ceiling Module	On-Center Channel Spacing	Field Panels	Panel Edge	Suspension System
150mm	1500mm	1500mm	HALCYON™ CLIMAPLUS™ 1350mm x 750mm	FL 	DXT™, DXI™, DXF™
				SL 	DX®
				SQ 	DX®
			MARS™ CLIMAPLUS™ 1350mm x 750mm	FLB 	DXT™, DXI™, DXF™
				SLT 	DX®
				SQ 	DX®
			MARS™ CLIMAPLUS™ High-NRC 1350mm x 750mm	FLB 	DXT™, DXI™, DXF™
				SLT 	DX®
				SQ 	DX®
			PANZ® Metal Panels, Solid 1350mm x 750mm	FL 	DXT™, DXI™

Module Layout

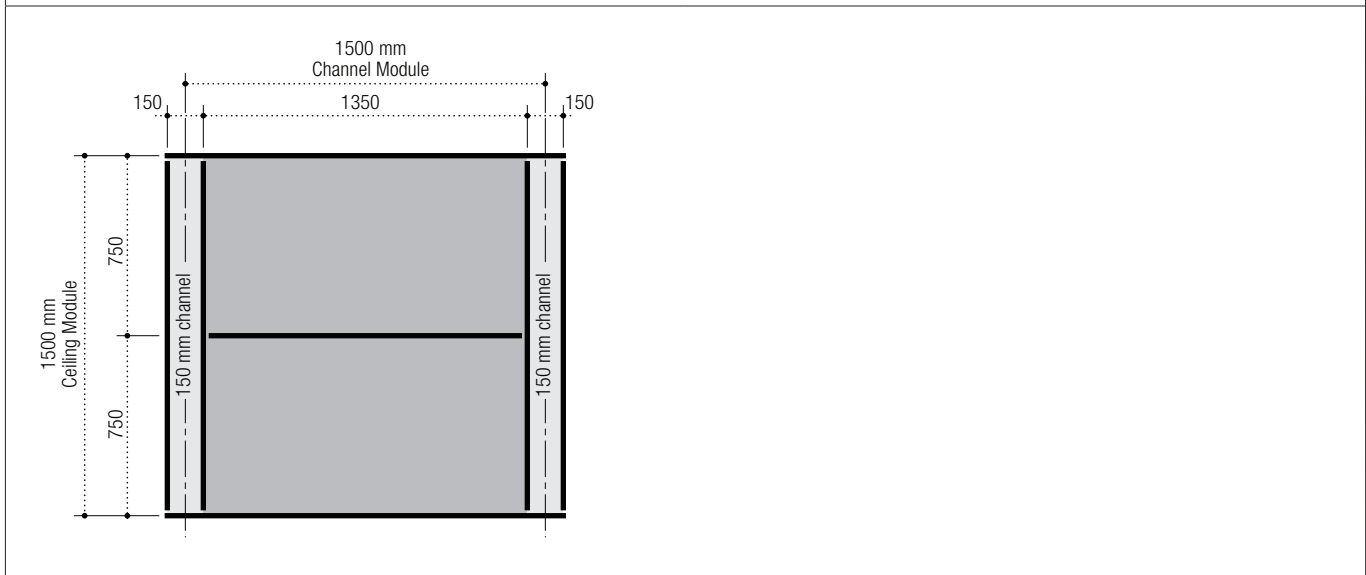

Panel Layout

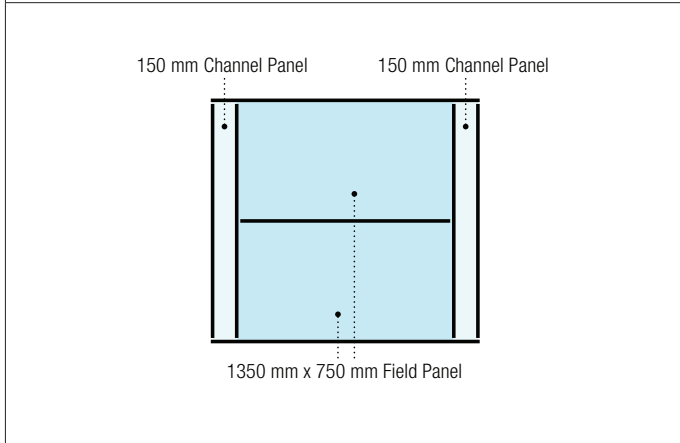

Suspension System Layout

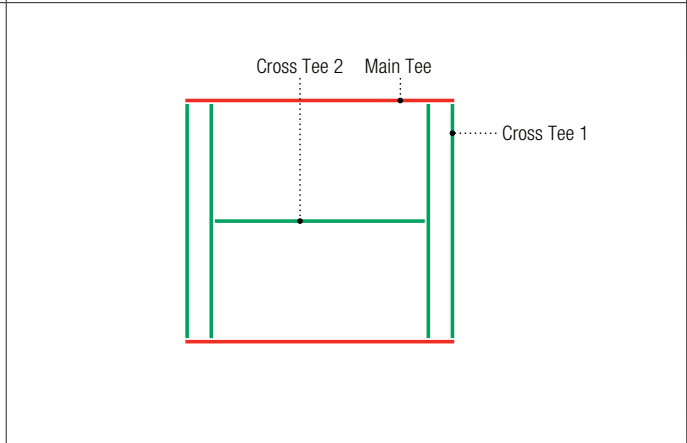



Step 1. Select Panels

Step 2. Select Edge for Panels

			FL/FLB		SL/SLT		SQ	
			Edge	Item No.	Edge	Item No.	Edge	Item No.
Field Panels	HALCYON™ CLIMAPLUS™	1350mm x 750mm	FL	<input type="checkbox"/> ME98359	SL	<input type="checkbox"/> ME98337	SQ	<input type="checkbox"/> ME97422
	MARS™ CLIMAPLUS™	1350mm x 750mm	FLB	<input type="checkbox"/> ME86831	SLT	<input type="checkbox"/> ME88686	SQ	<input type="checkbox"/> ME86503
	MARS™ CLIMAPLUS™ High-NRC	1350mm x 750mm	FLB	<input type="checkbox"/> ME86501	SLT	<input type="checkbox"/> ME86464	SQ	<input type="checkbox"/> ME86427
	PANZ® Metal Panels, Solid	1350mm x 750mm	FL	<input type="checkbox"/> ME909972				
Channel Panels	HALCYON™ CLIMAPLUS™	150mm x 1500mm	FL	<input type="checkbox"/> ME97573	SL	<input type="checkbox"/> ME97570	SQ	<input type="checkbox"/> ME97490
	MARS™ CLIMAPLUS™	150mm x 1500mm	FLB	<input type="checkbox"/> ME86835	SLT	<input type="checkbox"/> ME86543	SQ	<input type="checkbox"/> ME86507
	MARS™ CLIMAPLUS™ High-NRC	150mm x 1500mm	FLB	<input type="checkbox"/> ME86333	SLT	<input type="checkbox"/> ME86443	SQ	<input type="checkbox"/> ME86145

Step 3. Select Corresponding Grid for Selected Panels

			Qty	Item No.	Qty	Item No.	Qty	Item No.
Suspension Systems	CENTRICITEE™ DX™	Main Tee		<input type="checkbox"/> MEDXT24SP206				
		Cross Tee 1	2	<input type="checkbox"/> MEDXT1500				
		Cross Tee 2	1	<input type="checkbox"/> MEDXT1350				
	IDENTITEE™ DX™	Main Tee		<input type="checkbox"/> MEDXI24SP206				
		Cross Tee 1	2	<input type="checkbox"/> MEDXI1500				
		Cross Tee 2	1	<input type="checkbox"/> MEDXI1350				
	DONN® DX®	Main Tee			<input type="checkbox"/> MEDX24SP206		<input type="checkbox"/> MEDX24SP206	
		Cross Tee 1			2	<input type="checkbox"/> MEDX1500	2	<input type="checkbox"/> MEDX1500
		Cross Tee 2			1	<input type="checkbox"/> MEDX1350	1	<input type="checkbox"/> MEDX1350

Suspension System Estimator

	Length	m ²	Main Tee Usage Per m ²	Cross Tee 1 Usage Per m ²	Cross Tee 2 Usage Per m ²	
System Module	1500mm	2.250	0.667	1.333	0.600	

Note: Multiply the ceiling area (SF) by the Usage Factor (UF). This calculation will determine lineal footage of suspension system components required. Please refer to page 11 for stabilizer bar usage.

Notes



Product Information

See usg.com for the most up-to-date product information.

Installation

Must be installed in compliance with ASTM C636, ASTM E580, CISCA and standard industry practices, within all applicable code requirements. Alternative assemblies and installation methods may be utilized when approved by the Authority Having Jurisdiction. USG recommends checking with the Authority Having Jurisdiction prior to designing and installing a suspended ceiling system.

Code Compliance

The information presented is correct to the best of our knowledge at the date of issuance. Because codes continue to evolve, check with a local official prior to designing and installing a ceiling system. Other restrictions and exemptions may apply. This is only intended as a quick installation reference.

ICC Evaluation Service, Inc., Report Compliance

Suspension systems manufactured by USG Interiors, Inc., have been reviewed and are approved by listing in ICC-Evaluation Service Report ESR-1222. Evaluation Reports are subject to reexamination, revision and possible cancellation. Please refer to usgdesignstudio.com or usg.com for current reports.

L.A. Research Report Compliance

DOWN brand suspension systems manufactured by USG Interiors, Inc., have been reviewed and are approved by listing in the following L.A. Research Report number: 25764.

Notice

We shall not be liable for incidental and consequential damages, directly or indirectly sustained, nor for any loss caused by application of these goods not in accordance with current printed instructions or for other than the intended use. Our liability is expressly limited to replacement of defective goods. Any claim shall be deemed waived unless made in writing to us within thirty (30) days from date it was or reasonably should have been discovered.

Trademarks

The following are trademarks of USG Interiors, LLC or a related company: Centricitee, DX, DXL, DOWN, DXI, FINELINE, HALCYON, IDENTITEE, LOGIX, MARS, USG, USG in stylized letters. GE Lighting Solutions, LLC is a subsidiary of the General Electric Company. The GE brand logo, Lumination are trademarks of the General Electric Company. © 2012 GE Lighting Solutions, LLC.

Safety First!

Follow good safety/industrial hygiene practices during installation. Wear appropriate personal protective equipment. Read MSDS and literature before specification and installation.